



guava easyCyte™ System

User Guide

For systems running guavaSoft™ software, version 3.1



Copyright	<p>© 2014 EMD Millipore Corporation, Inc. All rights reserved.</p> <p>No part of this publication may be reproduced, transmitted, transcribed, stored in retrieval systems, or translated into any form, or by any means: electronic, mechanical, magnetic, optical, or otherwise, without the prior written permission of EMD Millipore Corporation, 25801 Industrial Blvd., Hayward, CA 94545, United States of America.</p>
Disclaimer	<p>EMD Millipore reserves the right to change its products and services at any time to incorporate the latest technological developments. This guide is subject to change without notice.</p> <p>EMD Millipore has thoroughly tested the operation of guavaSoft™ Software on Microsoft® Windows® XP and Windows® 7 operating systems, but does not warrant that the software functions correctly on any other operating system.</p> <p>EMD Millipore has not validated the analysis of guava easyCyte™ System data using third-party programs and cannot warrant that the results using these programs will be correct. EMD Millipore does not provide support for any third-party programs.</p>
Limitations	<p>The guava easyCyte™ System is for research use only; not for use in diagnostic procedures. The results of the assays are dependent upon the proper use of the reagents and instrument. Please refer to the appropriate package insert for specific instructions and limitations.</p>
Trademarks	<p>The M logo is a trademark of Merck KGaA, Darmstadt, Germany.</p> <p>Millipore, FlowCelect, InCyte, easyCheck, guavaSoft, ViaCount, Nexin, and guava are registered trademarks or trademarks of EMD Millipore Corporation.</p> <p>Microsoft, Windows, Internet Explorer, and Excel are registered trademarks of Microsoft Corporation.</p> <p>Dell is a trademark of the Dell Computer Corporation.</p> <p>All other trademarks are property of their respective companies.</p>
Patents	<p>The guava easyCyte™ System is the subject of issued and pending US patents and foreign equivalents, including the following US patents:</p> <p>5,798,222 – Apparatus for monitoring substances in organisms</p> <p>6,403,378 – Cell Viability assay reagents</p> <p>6,710,871 and 6,816,257 – Method and apparatus for detecting microparticles in fluid samples</p> <p>7,320,775 – Exchangeable flow cell assembly with a suspended capillary</p> <p>7,410,809 – Particle or cell analyzer and method</p> <p>8,184,271 and 7,847,923 – Differentiation of flow cytometry pulses and applications</p>

Table of Contents

Preface	vii
About This Guide	viii
Safety	viii
Limitations	x
Chapter 1: Introduction	
guava easyCyte™ System	1-1
System Components	1-2
Hardware Connections	1-2
easyCyte™ System Troubleshooting	1-4
easyCyte™ Instrument	1-6
guavaSoft™ Software Overview	1-8
Main Menu	1-8
Unlocking guava InCyte™	1-10
FlowCollect® Templates	1-11
guava InCyte™ Overview	1-12
About guava InCyte™	1-12
Tool Bar	1-13
InCyte™ Acquisition Screen	1-14
InCyte™ Analysis Screen	1-18
Exiting the Assay	1-19
Files	1-20
Instrument Settings	1-22
Chapter 2: Getting Started	
System Startup and Shutdown	2-1
Startup	2-1
Shutdown	2-2
Quitting guavaSoft™ Software	2-2
Running the easyCheck™ Procedure	2-3
easyCheck™ Results	2-4
Viewing and Exporting easyCheck™ Results	2-5
Viewing Trend Data	2-7
easyCheck™ Procedure Troubleshooting	2-8
Chapter 3: Cleaning and Maintenance	
Running Quick Clean	3-1
Running Guava® Clean	3-2
Backflushing the Fluid System	3-4
Filling the Cleaning Solution Vial	3-4

Emptying the Waste Vial	3-5
Cleaning the Flow Cell	3-6
About the Flow Cell	3-6
Using the Syringe Tool to Clean the Flow Cell Assembly	3-6
Replacing the Flow Cell	3-10
Replacing the Fuses	3-12
Returning the System for Service	3-13

Chapter 4: guava InCyte™ Assay

Introduction	4-1
InCyte™ Application Window	4-2
Plots	4-2
Pie Legend	4-5
guava InCyte™ Sample Acquisition	4-6
guava InCyte™ Analysis	4-13
The Analysis Panes	4-14
Analyzing Files Acquired Using InCyte™	4-15
Analyzing Files Acquire Using Other guava® Software Modules	4-17
Regions, Gates, and Statistics	4-19
Regions	4-19
Gates	4-22
Stat Markers	4-26
Exporting Results	4-33
Compensation	4-34
Performing Manual Compensation	4-34
Performing Semi-automated Compensation	4-36
HeatMap	4-38
Creating a HeatMap	4-39
Thresholds	4-43
Metrics	4-43
IC-50/EC-50	4-44
Creating an EC-50 or IC-50 Curve	4-45
Special Features	4-46
Creating a Group	4-46
Data Pooling	4-48
Overlaying Histograms	4-49
Printing Results	4-50
guava InCyte™ Troubleshooting	4-51

Appendix A: Administrator Features **A-1**

Setting up Access Control	A-1
Administration Configuration	A-8

Appendix B: Glossary **B-1**

Appendix C: Ordering Information **C-1**

Specifications	1
guava easyCyte™ System	1
easyCyte Lasers and Fluorescent Filters	3
Fluorochromes	4
Compliance	5
Symbols	5
Notice to Purchaser: Limited Use License	6
Warranty	7
Index	9

Preface

The guava easyCyte™ System is an automated, desktop cell analysis system that can perform a wide range of multi-color cellular and assays. The system is equipped with three lasers—violet, blue, and red—allowing you to analyze up to 10 fluorescence parameters, as well as forward and side scatter. It accommodates individual microcentrifuge sample tubes.

guavaSoft™ software, used to set up and maintain the system, offers a number of assay-specific acquisition and analysis modules, depending on your applications. Use the guava InCyte™ software module to acquire and analyze data. InCyte™ is an open software package, which you can also use to analyze FCS 3.0 data files acquired from any guava® software module. For a list of assay-specific software modules, see “Program Search List” on page 1- 9.

guava InCyte™ application templates are available for all FlowCollect® assays. The templates provide the plots, parameters, analysis tools (Methods), and statistics for each application. For more information on these templates, refer to the specific reagent kit user guide.

About This Guide

The *guava easyCyte™ System User Guide* provides detailed information on operating and maintaining the guava easyCyte™ System, and using the guava InCyte™ software module for data acquisition and analysis. This guide is intended for the guava easyCyte™ 5, 6-2L, 8, and 12 instruments. Any reference to NIR, Red2, and NIR2 parameters, may not apply to your specific instrument. Refer to “easyCyte Lasers and Fluorescent Filters” in Specification for a complete list of the parameters available with each system. For information on using the other guava® software modules, refer to the *guavaSoft™ Modules User Guide*.

This guide assumes you have a working knowledge of Microsoft® Windows® operating system. If you have any questions regarding the Dell™ computer or the operating system, refer to the appropriate manufacturer’s documentation.

For information on preparing samples, refer to the appropriate reagent kit user guide that was shipped with your reagents.

Conventions Used in This Guide

■ **NOTE:** Points out additional information that may be helpful.

◆ **WARNING:** Alerts you to situations that could result in bodily harm, instrument damage, failure in a procedure, or incorrect results.

Bold: Indicates buttons to click or options within the software to select.

Italics: Used for names of user guides and package inserts, as well as messages that appear on the screen.

Help

- 1 Read through the section of the guide specific to the operation you are performing. Refer to the table of contents and index to locate information. A glossary is included to assist you with any unfamiliar terms.
- 2 See the Troubleshooting section in each chapter for a list of problems and suggested solutions.
- 3 Refer to the technical support contact information listed below:
 - For ordering information or technical support, call toll-free:
USA and Canada, Phone: +1 (800) 645-5476 Fax: +1 (951) 676-9209
 - For additional contact information, visit www.millipore.com/flowcytometry

Safety

The guava easyCyte™ System is equipped with safety features for your protection. Use the system only as directed in this user guide. Do not perform instrument maintenance or service except as specifically stated. Please read the following safety information before using the system.

General Safety

- ◆ **WARNING:** If this instrument is not used in the manner indicated by the instructions in this guide, the safety features of the instrument may be impaired. Follow these guidelines:
 - The use of tubes other than those specified may result in damage to the instrument.
 - Do not run any other programs, including Internet Explorer[®], on the laptop while using guavaSoft[™] Software to acquire data. guavaSoft[™] Software requires the full resources of your laptop during data acquisition. Running other programs during a run may interfere with acquisition or interrupt the run.

Biological Safety

- ◆ **WARNING:** All biological specimens and materials that come into contact with them can transmit potentially fatal disease. To prevent exposure to biohazardous agents, follow these guidelines:
 - Handle all biological specimens and materials as if capable of transmitting infection. Dispose of waste using proper precautions and in accordance with local regulations. Never pipette by mouth. Wear suitable protective clothing, eyewear, and gloves.
 - Add 10 mL of bleach to the waste vial after emptying it. Dispose of waste in accordance with federal, state, and local regulations.

Electrical Safety

The instrument must be connected per the instructions in the user guide. The power conditioner is required to meet electrical compliance.

- ◆ **WARNING:** Turn off the main power switch at the back of the instrument and disconnect the power cord before replacing fuses.

Laser Safety

The following lasers are used in the easyCyte[™] System:

Laser	Wavelength (nm)	Maximum Power (mW)
Violet	405 ±5	110
Blue	488 ±5	160
Red	642 ±5	110

- **NOTE:** These are the maximum powers for each laser. For the actual power for a specified instrument model, see “easyCyte Lasers and Fluorescent Filters” under Specifications.

No radiation is accessible to the user during normal operation and maintenance. Light shields within the instrument enclose the path of laser radiation. Additionally, the instrument enclosure provides secondary protection from any laser radiation.

- ◆ **WARNING:** To avoid exposure to laser radiation or electric shock, follow these guidelines:
 - *Do not* open the instrument or attempt to perform any internal maintenance. There are no user-serviceable parts.
 - Turn off the power to the guava easyCyte™ System before attempting to remove the flow cell.
- ◆ **WARNING:** The use of controls or adjustments or performance of procedures other than those specified herein may result in hazardous radiation exposure

Labels

Following are examples of the labels affixed to the guava easyCyte™ instrument:

NOTE: The following caution label is visible when the flow cell access panel is removed. The panel is to be removed when the system is powered off. Even when powered on, the accessible laser radiation falls within Class I limits.

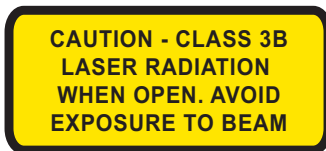

Passed
By: <u>D.C.</u>
Date: <u>7/08/05</u>

S/N: 8470120101
Manufactured: 04JUN2014
M EMD Millipore Corporation

M	EMD Millipore Corporation 25801 Industrial Blvd. Hayward, CA 94545 (510) 576-1400
	guava easyCyte™
60/50Hz, 100-240 V ~ 80W	
Class 1 Laser Product	
Complies with 21 CFR Chapter 1 Subchapter J.	
Caution consult accompanying documents	
MADE IN USA 1000-5590 Rev B	

	USA and Japan	Europe
	110 VAC	220 VAC
FUSE	2A Time-Lag	1.6A Time-Lag



Limitations

- The guava easyCyte™ System is for research use only; not for use in diagnostic procedures.
- The results of the assays are dependent upon the proper use of the reagents and instrument. Refer to the appropriate reagent kit user guide for specific instructions and limitations.

CHAPTER 1

Introduction

guava easyCyte™ System

The guava easyCyte™ System streamlines cell phenotyping, drug discovery, and cell culture monitoring and screening by providing turnkey assays for a wide range of cell-based applications. The system includes the easyCyte™ instrument, a laptop computer with pre-installed software for data acquisition and analysis, and optimized reagents and protocols.

guavaSoft™ software includes dedicated application modules for cell- and bead-based assays, minimizing training requirements. In addition, the software includes the guava easyCheck™ module, which verifies that the system is performing optimally, and Guava Clean, a cleaning module that allows you to clean the instrument's fluid system prior to shutdown.

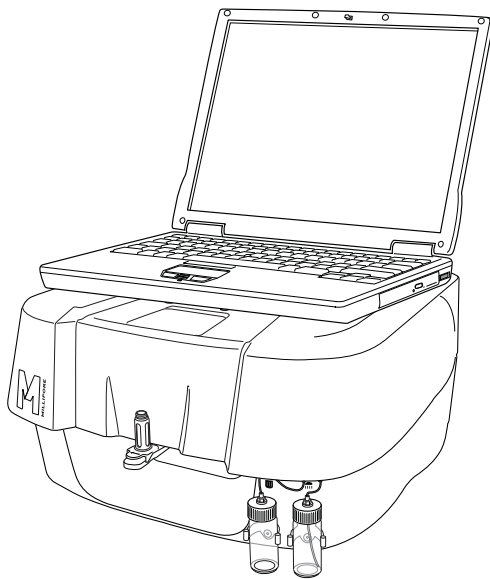

guava easyCyte™ System

guavaSoft™ software automatically saves data files, which can be recalled later for offline analysis. In addition, results are exported to a spreadsheet file.

System Components

The easyCyte™ System is shipped with the following components.

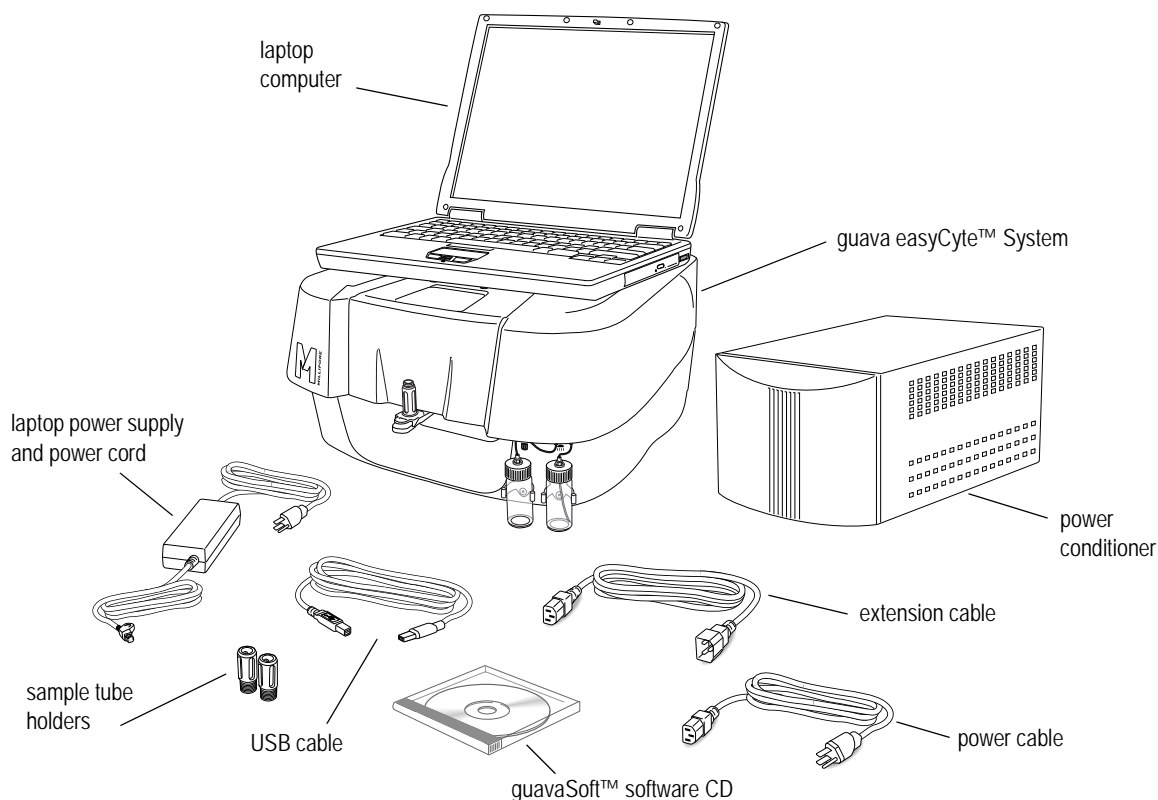

Hardware Connections

Although the easyCyte™ System is a portable unit, it contains precisely aligned optical components that are sensitive to jarring movements. Place the instrument on a stable surface in a dedicated location in the laboratory. Allow at least 4 inches between the back of the instrument and the wall for proper ventilation. Maintain easy access to the power cord in case the instrument needs to be disconnected in an emergency. The initial installation will be performed by an EMD Millipore field service representative.

- ◆ **WARNING:** To avoid damage to the instrument, be sure to remove the shipping restraint before plugging in the instrument.
 - **NOTE:** If the instrument needs to be moved to a new location in the lab area or building, always use two people to lift and a sturdy transport such as a cart. If a longer distance move requiring packup is required, contact EMD Millipore. A Relocation and Installation service is available for a fee. See Appendix C: "Ordering Information" for details.
- 1 Connect the cytometer to the laptop with the USB cable (see Figure on page 1-3).
 - 2 Connect the power cable between the power conditioner and a grounded (three-prong) AC power outlet.

- 3 Connect the extension cable between one of the four power outlets on the back of the power conditioner and the power input on the cytometer.
 - **NOTE:** The power conditioner is required to meet electrical compliance.
- 4 Connect the laptop power supply to the laptop. Plug the power supply into the power cord, then plug the power cord into the power conditioner.
- ◆ **WARNING:** The power conditioner is not a continuous power supply. Ensure that the instrument is powered on during acquisition.

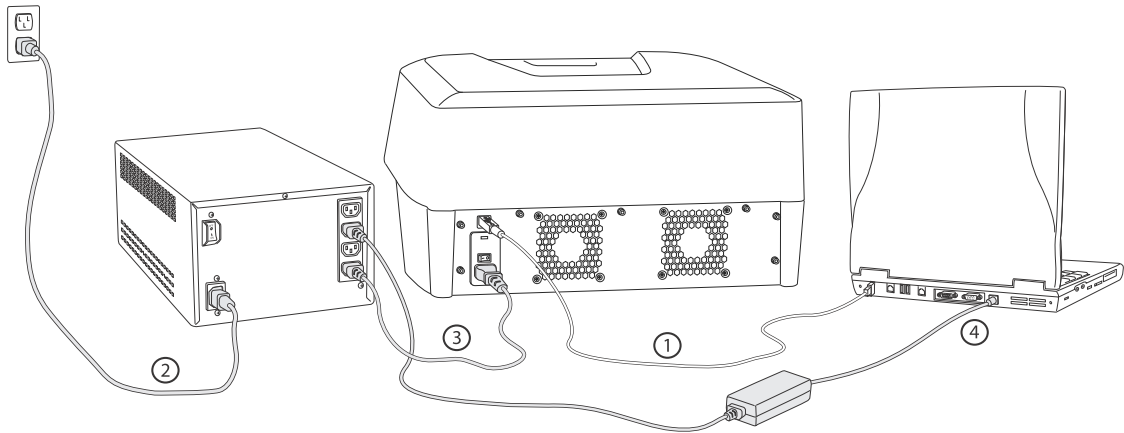

Connecting the guava easyCyte™ System

- 5 You can connect the laptop to a local network or the internet. Contact your network administrator for assistance. You can also connect a printer. If you connect a printer, you must install the appropriate print drivers.
- 6 The easyCyte™ System comes with two sets of sample tube holders: a set of holders for 1.5-mL microcentrifuge tubes and a set of holders for titer tubes. Select the set you want to use and install them by screwing each holder onto the loader assembly as illustrated below.

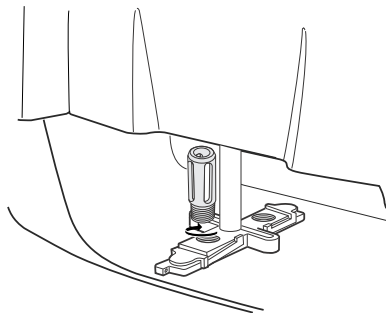

Installing and changing the tube holders

The easyCyte™ System supports the following tubes:

- 1.2-mL microtiter tube with conical tip
- 1.5-mL microcentrifuge tube with conical tip and screw cap (if snap-cap tubes are used, cut off the cap)

- ◆ **WARNING:** The use of tubes other than those specified may result in damage to the instrument.
- 7 Refer to “System Startup and Shutdown” on page 2-1 for the correct procedure to start the laptop computer, easyCyte™ instrument, and guavaSoft™ software.
- 8 Prime the fluid system. Follow the instructions in “Running Guava® Clean” on page 3-2 using deionized water in place of cleaning solution. Keep the tube of water loaded on the system whether you are ready to run samples or are going to shut down the system.

easyCyte™ System Troubleshooting

Problem	Possible Causes	Solutions
Laptop prompts for user ID or password.	Laptop is set up for authorization.	Do not enter password. Click OK or Cancel to continue. Contact your IT department for assistance with any modifications. The original laptop setup does not require a password.
During start-up, laptop freezes on particular screen.	System may be searching for directory during startup.	Press Enter to continue. Reboot system, if necessary.
Message: <i>The instrument could not be detected.</i>	Communication problem.	Press Enter to continue. Reboot system, if necessary. If message appears after rebooting, contact EMD Millipore Technical Support.
Message: <i>The instrument appears to be either off or not connected. You can run in Analysis mode only.</i>	<ol style="list-style-type: none"> 1. guava easyCyte™ System is not turned on or is not getting power. 2. Cable connection between easyCyte™ System and laptop is loose. 3. easyCyte™ System and laptop were not powered on in correct sequence or have lost communication. 	<ol style="list-style-type: none"> 1. Ensure easyCyte™ System power cord is properly plugged in and system is turned on. 2. Ensure USB cable is securely connected to laptop. Use USB 2.0 ports if possible. Reboot computer, if necessary. 3. Turn off easyCyte™ System, exit guavaSoft™ software, restart laptop, turn on easyCyte™ System, wait for indicator light before starting the software.
guavaSoft™ software launches, but only Analysis mode is available when an assay is launched.	Registration code not entered or not entered correctly.	Enter registration code and ensure all characters are correct.

Problem	Possible Causes	Solutions
Instrument will not power on.	Loose power cable.	Ensure instrument is plugged. Check all power connections.
Laptop keeps shutting down.	<ol style="list-style-type: none"> 1. Power supply to laptop is faulty. 2. Screen saver is interfering. 3. Laptop overheating. 	<ol style="list-style-type: none"> 1. Ensure laptop is plugged in correctly. Use surge protector and ensure it is plugged in and turned on. 2. Adjust power scheme screen saver options. Click Start> Settings>Control Panel. Double-click Display, select Screen Saver tab, click Settings under <i>Energy saving features of monitor</i>. Make sure "Setting for Always On power scheme" are all set to Never. Laptop should not be allowed to "sleep." guavaSoft™ software will stop acquiring data until the laptop is woken up. 3. Ensure cooling vents are clean and unobstructed.
For InCyte™ only Message: <i>Sorry - this unlock is invalid.</i>	Incorrect or no unlock key.	Ensure the correct unlock key is entered. If necessary, contact EMD Millipore Technical Support to obtain unlock key.

- ◆ **WARNING:** Do not run Excel® software, Internet Explorer® browser, or any other program on the laptop while using guavaSoft™ software to acquire data from the guava easyCyte™ System. guavaSoft™ software requires the full resources of your laptop during data acquisition. Running other programs (even if you are not actively using them) during a run may interfere with acquisition or interrupt the run.

easyCyte™ Instrument

The easyCyte™ System was designed for easy operation and minimal maintenance. The power switch, sample loader, and waste and cleaning solution vials are the only instrument components that you will routinely handle, and most of your interaction is through the software via the laptop. The power switch is located on the back-right side of the instrument.

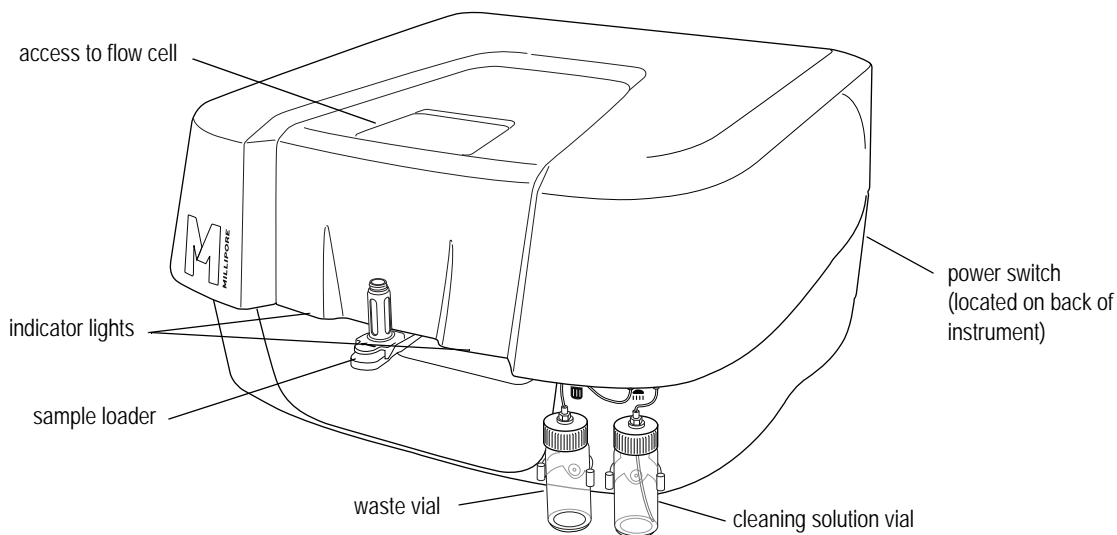

guava easyCyte™ System and components

Sample Loader

The sample loader holds up to two sample tubes. The loader arm can be lowered and swiveled, allowing you to quickly switch from one sample to the next during acquisition.

To load samples, pinch the release lever with your thumb and forefinger and gently lower the arm assembly (figure 1). Once lowered, rotate the assembly to change the sample tube (figure 2), then push up on the assembly until you hear a click.

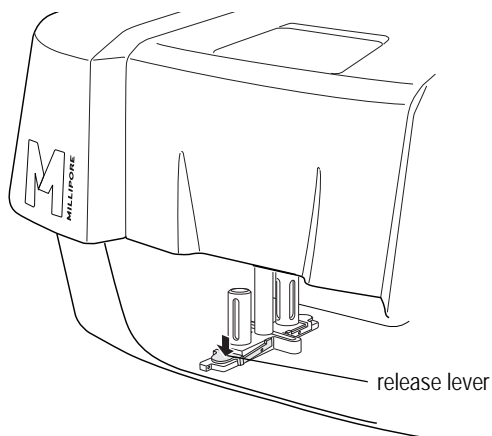

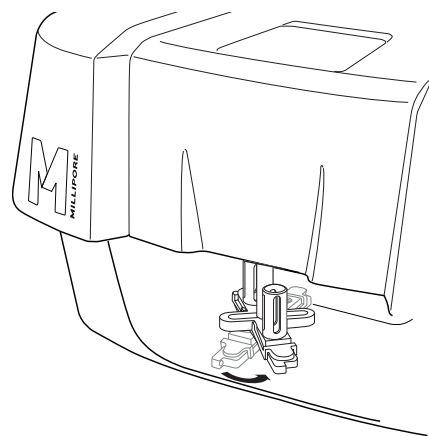

1. Pinch release lever and gently lower sample holder.



2. Rotate loader assembly to change tubes.

Cleaning Solution and Waste Vials

The cleaning solution vial (located on the right ) can be filled with Guava[®] Instrument Cleaning Fluid (ICF), for easy system cleaning. For information on filling the vial, refer to “Filling the Cleaning Solution Vial” on page 3-4.

The waste vial (located on the left ) captures the sample fluid after it exits the fluid system. Empty the waste vial at the end of each day or more often, if necessary. Add 5 mL of bleach to the vial after you empty it (see page 3-5 for information).

Fluid System

Sample uptake occurs through a capillary and is regulated by a variable-speed fluid pump. The pump does not require sheath fluid or other supplementary fluids for operation.

Because the system’s sampling precision depends on the integrity of the fluid pathway, it is important to maintain a clean system. Do not allow samples to remain in the capillary for extended periods of time. Perform frequent cleaning cycles to prevent the build-up of cellular debris that may restrict sample flow. Always keep a tube on water loaded when the instrument is not in use. If a clog does occur, you can clear it by using the backflush feature, which reverses the flow of fluid and flushes it out of the flow cell at a high speed. Refer to “Backflushing the Fluid System” on page 3-4 for detailed instructions on using the backflush feature.

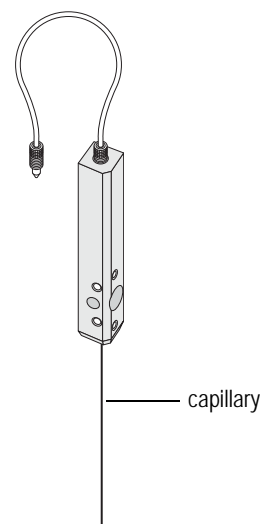

Some assays allow you to select the sample flow rate for acquisition. For most assays, the Medium flow rate is the default. This works well when the sample concentration is approximately 500 particles/ μ L. If the sample concentration is higher, dilute the sample or use a lower flow rate. For assays where the peak CV is critical, such as Cell Cycle, use the Low or Very Low flow rate. Always use the same flow rate for acquisition that you use for adjusting the settings.

Laser

The guava easyCyte[™] has three lasers—blue, violet, and red. During acquisition using InCyte[™] or easyCheck[™], all three lasers turn on. During acquisition using ExpressPro, the blue and red lasers turn on. During acquisition using any of the other guava[®] software modules, only the blue laser turns on. The lasers turn off when acquisition is complete.

■ **NOTE:** For information on the easyCyte[™] lasers and the fluorochromes compatible with each, refer to "easyCyte Lasers and Fluorescent Filters" in Specifications.

Software CD

A CD contains guavaSoft[™] software. The *guava easyCyte[™] System User Guide* is installed with the software.

guavaSoft™ Software Overview

Use guavaSoft™ software for the acquisition and analysis of data.

Main Menu

The guavaSoft™ software main menu allows you to select an assay from either a list of favorites or the program search list. Essential Tools allows you to run easyCheck™, clean the instrument, or select Setup, where you can customize your list of favorites. Use links @ Millipore to quickly access EMD Millipore websites for information.

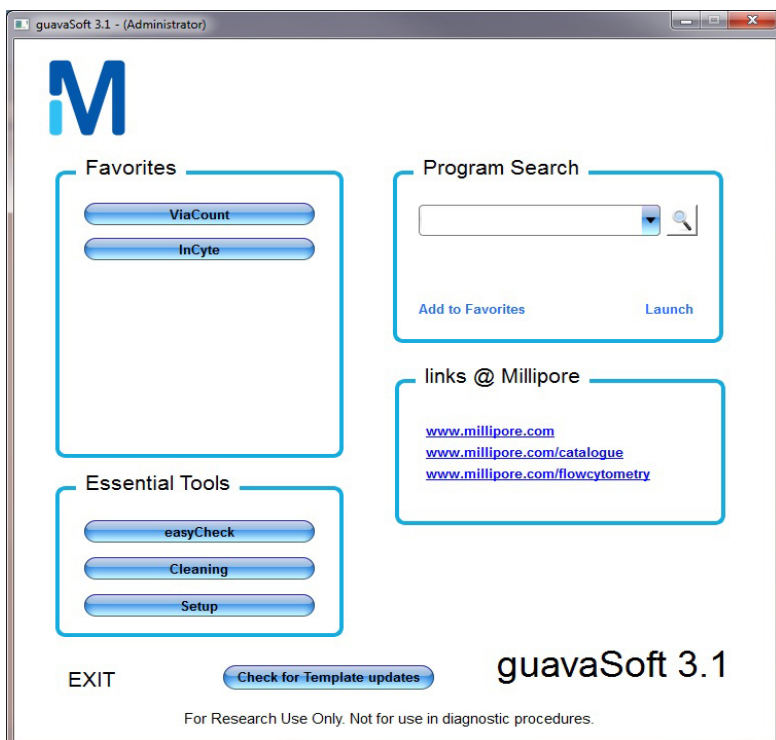

guavaSoft™ software main menu

Favorites

Favorites allows you to quickly select an assay. You can have up to seven assays at a time in your Favorites list. To add a favorite assay, select the assay from the Program Search list and click **Add to Favorites**. The new assay will be added to the bottom of the list. And if the list already consists of seven assays, the first assay in the list will be removed.

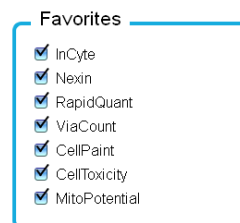

To remove a favorite assay, click **Setup** under Essential Tools. Remove the check from the check box for the assay you wish to remove. Click **DONE**.

Program Search List

The Program Search List allows you to select an assay to run or open a FlowCollect[®] template in InCyte[™]. You can create a Favorites list to quickly select an assay later. The main menu allows you to select from the following assays:

- guava **ViaCount[®] Assay** for performing cell counting and viability assays
- guava[®] **ExpressPro Assay** for performing assays with up to six colors, or where time, area, and/or width parameters are necessary
- guava **InCyte[™]** for performing assays with up to ten colors and two scatter parameters, or where time, area, and/or width parameters are necessary, or if you want to analyze any guava FCS 3.0 data files
- guava **Nexin[®]**, guava[®] **Caspase**, guava[®] **TUNEL**, and guava[®] **MitoPotential Assays** for performing apoptosis assays
- guava[®] **Cell Cycle Assay** for performing DNA cell cycle assays
- guava[®] **CellPaint Assay** for tracking target cells in mixed populations, or for monoclonal antibody (mAb) screening in mixed cultures
- guava[®] **CellToxicity Assay** for cell-mediated cytotoxicity determinations
- guava[®] **CellGrowth Assay** for cell proliferation studies and to assess the number of live versus dead cell

Additionally, FlowCollect[®] template are available for acquisition and/or analysis using InCyte[™]. See “FlowCollect[®] Templates” on page 1-11.

Essential Tools

guava **easyCheck[™]** allows you to check the system’s counting, fluorescence, and scatter performance prior to running samples. The guava easyCheck[™] Bead is a standard particle used with this tool.

Cleaning allows you to run Guava Clean, an automated system cleaning cycle that cleans the fluid system.

Setup allows administrators to:

- configure certain software features for specific users (see “Appendix A: Administrator Features” for more information)
- remove assays from your Favorites list
- enter assay registrations codes (see “Unlocking guava InCyte[™]” on page 1-10)

■ **NOTE:** The Setup button is available only when an administrator is logged onto the system.

links @ Millipore

This section allows you to access commonly used EMD Millipore websites. You must have internet access.

Check for Template Updates

Select **Check for Template updates** to search online or, if you are not connected to the internet, any available USB drives, for the latest FlowCollect® templates. The system will notify you if you currently have the latest templates installed.

- 1 If updated templates are available, the following dialog appears. Click **Yes** to install the latest template package.
Click **Export** to download the templates to a USB drive.

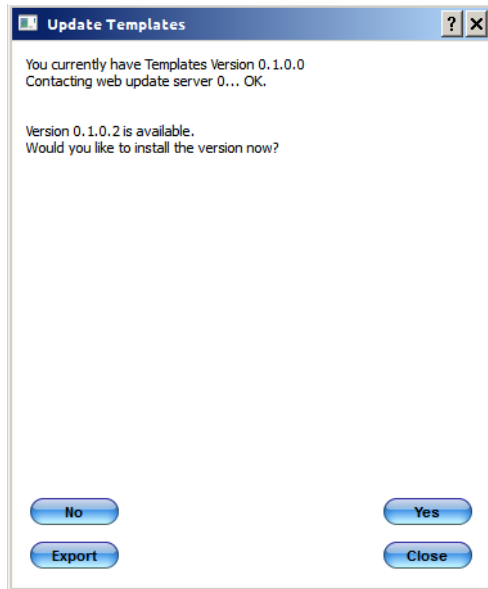

- 2 Click **Close** when you receive confirmation that the latest templates were installed. If you chose to export the templates to a USB drive, select the drive from the drop-down menu and select **Export**.

Exit

Closes guavaSoft™ software

Unlocking guava InCyte™

guava InCyte™ requires an unlock key. If you get a message containing your computer code and prompting for an unlock key, e-mail EMD Millipore Technical Support and they will provide you with an unlock key for InCyte™.

FlowCollect® Templates

Software templates are available for all FlowCollect® assays. The templates can be used for acquisition and/or analysis. Open a template before acquiring your samples in InCyte™. The instrument settings, plots, gates, and markers for the assay are contained in the template. If you already acquired data using either InCyte™ or another guavaSoft™ module, open the data file in the template and perform analysis using the Analysis Method provided.

Templates for the following assays are available:

- FlowCollect® **Cytochrome c** for mitochondrial cytochrome c loss
- FlowCollect® **Human CD4/CD8 T Cell** for quantification on CD4 and CD8 T cells
- FlowCollect® **Human T Cell Caspase** for caspase activation in CD4 and CD8 T cells
- FlowCollect® **MitoCaspase** for caspase and mitochondrial membrane depolarization detection
- FlowCollect® **MitoDamage** for apoptosis, mitochondrial membrane depolarization, and cellular death detection
- FlowCollect® **MitoPotential Red** for mitochondrial membrane depolarization and cellular death detection
- FlowCollect® **Th1/Th17** for Th1 and Th17 intracellular cytokine detection

Using a FlowCollect® Template

For more information on using the templates, refer to the user guide for the individual assay kit.

- 1 To open a template, select it from the Program Search list and click **Launch**. The assay template opens in InCyte™.
- 2 Select the Analyse or Acquire button at the top of the control panel. Perform acquisition or analysis according to the instructions outlined in the kit user guide.
 - If you are acquiring samples, the instrument settings should be close to what you need. Check the settings and fine tune, if necessary.
 - If you are analyzing InCyte-acquired data, but you acquired the data without the use of a template, you will need to drag the template Analysis Method to the Analysed Group. Check the gates and markers and fine tune, if necessary.
 - If you are analyzing a data file acquired using a program other than InCyte™, open the data file. The assay template will contain the appropriate Analysis Method. You will need to create an Analysed Group and drag the data file and the Analysis

Method to the Analysed Group. Check the gates and markers and fine tune, if necessary.

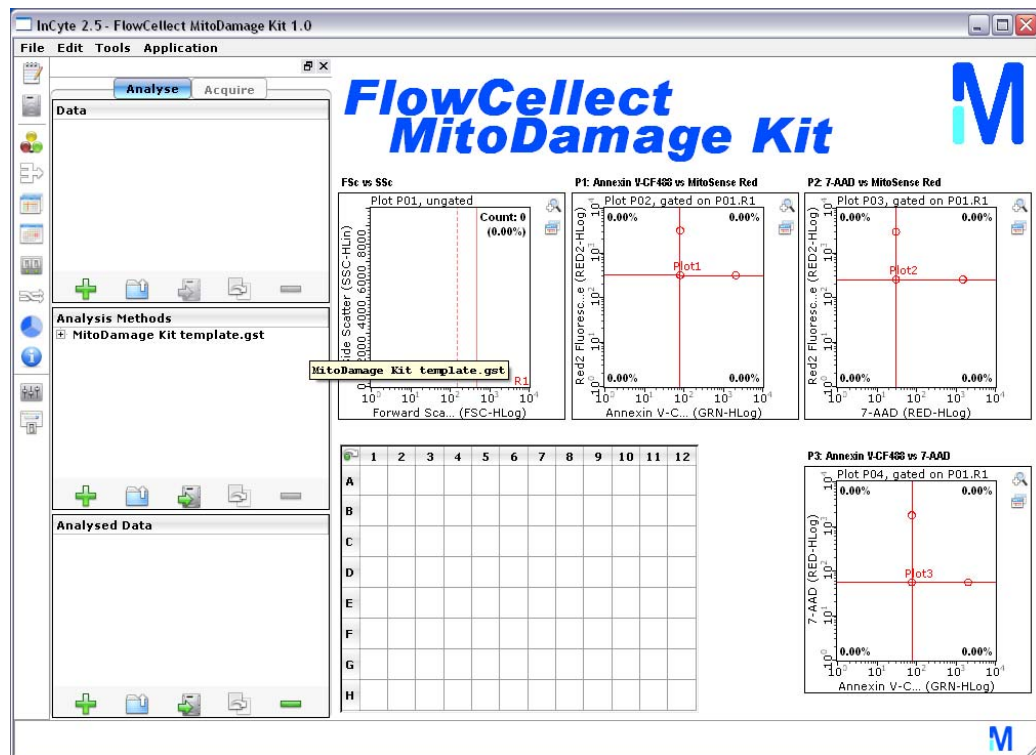

guava InCyte™ Overview

About guava InCyte™

guava InCyte™ was developed to be an open assay module providing all the tools for instrument setup, sample acquisition, and data analysis.

The guava InCyte™ module allows you to acquire and analyze up to ten fluorescence parameters in combination with forward scatter (FSC) and side scatter (SSC), as well as area, width, and time. It provides automated compensation and an instant update feature, making it easier to perform complex analysis.

Key Features

A single Method (or analysis strategy) can be applied to multiple data sets in parallel, or multiple Methods can be applied to a single data set to obtain statistics to be displayed in the heat map. The process of creating equation-based gating schemes has been simplified through use of drag-and-drop regions; “draggable” features are used throughout InCyte™.

The HeatMap allows you to visually compare results using a plate map that displays varying shades of blue to represent relative statistical values. Results from up to six parameters or six data sets can be displayed simultaneously.

Additionally, all channels can be used with reagents that fluoresce in appropriate channels. Refer to "easyCyte Lasers and Fluorescent Filters" in the Specifications section for filter information.

Components of InCyte™ Files

Data files acquired using InCyte™ contain raw FCS data, the analysis components also known as Methods (regions, gates, markers, statistics, etc), instrument settings, and compensation settings. The raw data combined with the Analysis Method make up the InCyte™ Analysed Group.



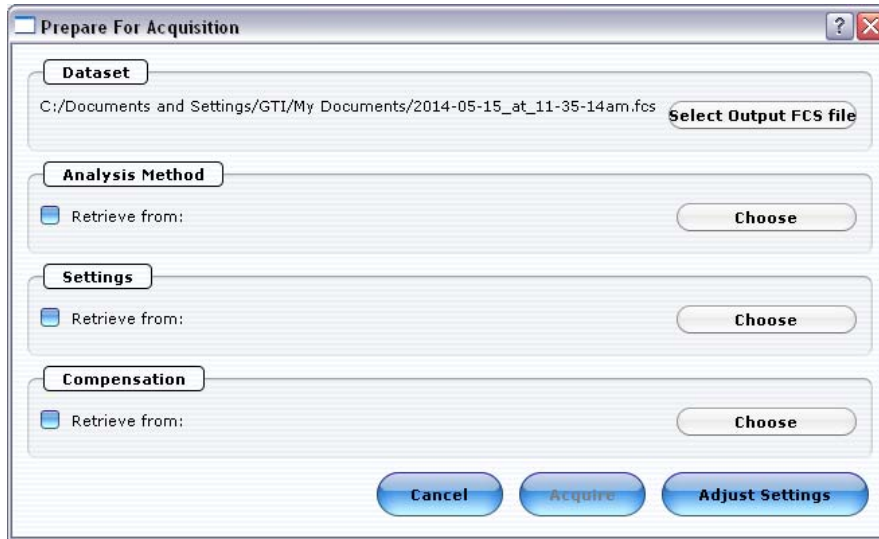









At the start of acquisition, you have the option to select a Method, instrument settings, and compensation settings. These components can be retrieve from a saved InCyte™ FCS file. You can also retrieve the Method and/or instrument settings from individual saved Method and instrument settings files. If you do not retrieve a Method, a default Method will be applied.



Tool Bar

The tool bar appearing on the far left side of the window provides additional features for acquisition and analysis. The features are also accessible from the Tools menu. Other than the Pie Legend, which is described on page 4-5, the tools are described in detail at

the point in the workflow where they are used.

-  Event Log
-  Show/Hide Acquisition Controls
-  Region List
-  Gate List
-  Show Current Run Stats
-  Show Group Stats
-  Show Instrument Settings
-  Show Compensation Controls
-  Show Pie Legend
-  Show Sample Info
-  Show Gain Controls
-  Show Miscellaneous Controls

InCyte™ Acquisition Screen

- ◆ **WARNING:** Do not run Excel® software, Internet Explorer® browser, or any other program on the laptop while using guavaSoft™ software to acquire data from the guava easyCyte™ System. guavaSoft™ software requires the full resources of your laptop during data acquisition. Running other programs (even if you are not actively using them) during a run may interfere with acquisition or interrupt the run.

The Acquisition screen appears when you enter the assay. Use the Acquisition screen to acquire data from samples you run on the easyCyte™ System. You can also perform data analysis from the Acquisition screen immediately following acquisition.

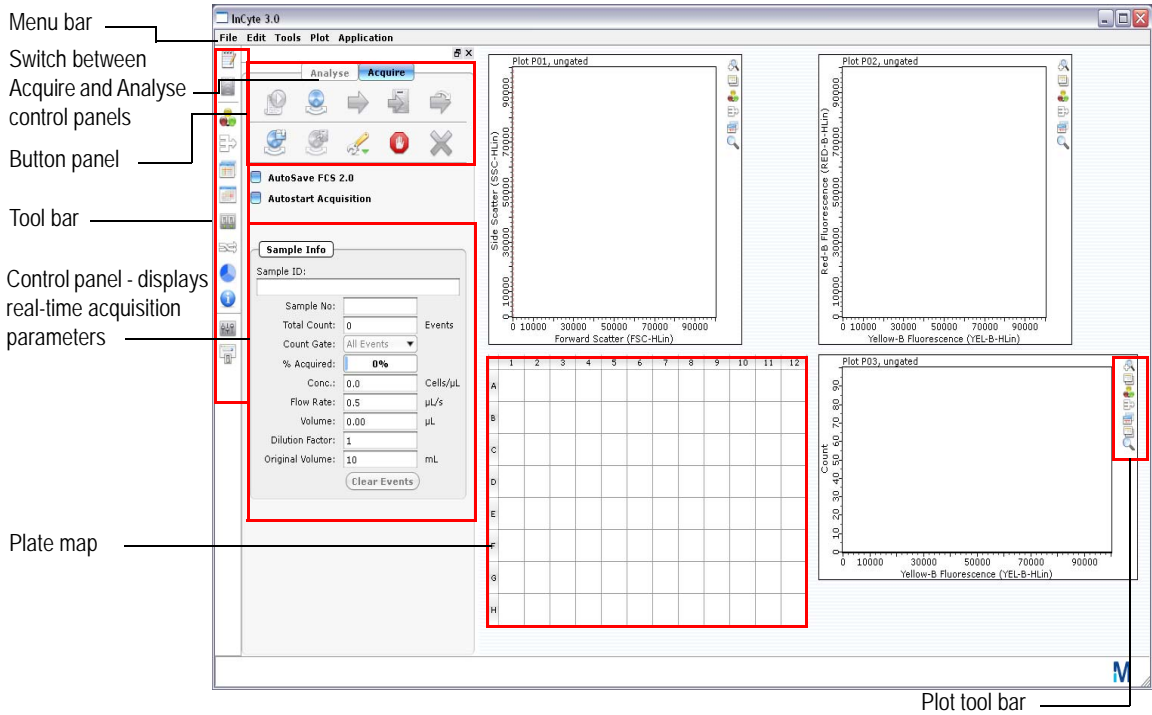

Acquisition Buttons

Place the cursor over the icon to display text describing the button.

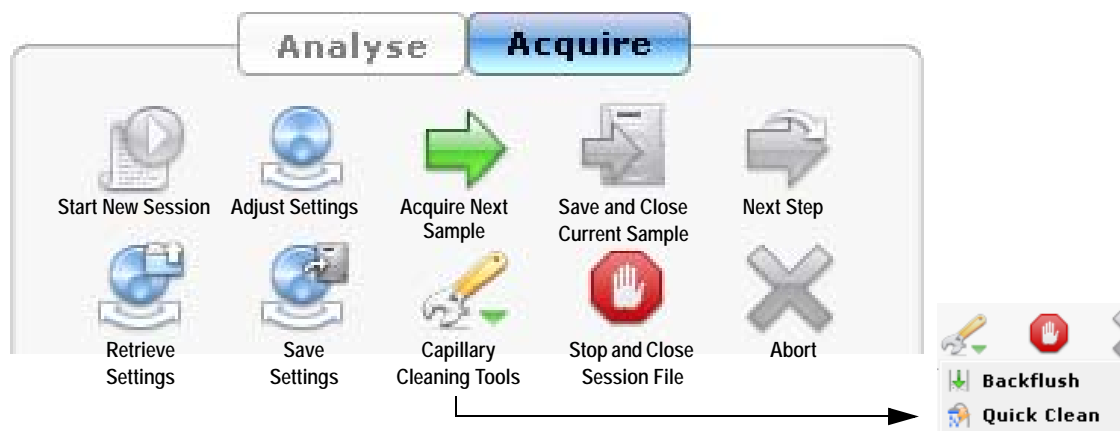

The following table describes the acquisition buttons.

Acquisition Button	Description
Start New Session File	Allows you to select the worklist file, the Method, instrument settings, and compensation, prompts you to load the for acquisition or the adjust settings, if applicable.
Adjust Settings	Allows you to adjust instrument settings using the appropriate sample.
Acquire Next Sample	<p>Begins data acquisition for the next sample. You can make changes to the sample information (except for Events to Acquire) after acquisition and before clicking Save and Close Current Sample. After clicking Save and Close Current Sample, the Sample # advances and any changes made to the sample information will apply to the next sample.</p> <p>■ NOTE: When Autostart Acquisition is checked, data acquisition starts automatically each time a new tube is loaded. Therefore, you do not need to click Acquire Next Sample or Save and Close Current Sample.</p>
Save and Close Current Sample	Saves the sample data. You can now acquire the next sample.
Next Step	Proceeds to the next step in the data acquisition process. The data already acquired is saved.
Retrieve Settings	Allows you to recall instrument and analysis settings from a settings file and download the settings to the easyCyte™ instrument. If this button is disabled, your system administrator may have chosen to not allow the retrieval of Methods and instrument settings from individual Method and instrument settings files. These settings can be retrieved only from an FCS file.

Acquisition Button	Description
Save Settings	Allows you to save the current instrument settings to a separate file.
Capillary Cleaning Tools	Backflush reverses the flow of fluid out of the flow cell. Perform a backflush if the acquisition rate declines and you suspect a clog. During acquisition, click Save and Close Current Sample before Backflush. Follow a backflush with a Quick Clean. Quick Clean cleans the fluid pathway. During acquisition, click Save and Close Current Sample before Quick Clean.
Stop and Close Session File	Stops the assay after finishing the acquisition for the current sample. After stopping you cannot resume.
Abort	Stops the session. The data for the current sample is not saved. You cannot resume an assay after you abort. You must start the assay from the beginning.

Autostart Acquisition

An automated sample acquisition feature saves you from having to click **Acquire Sample** and **Save and Close Current Sample**. Check the Autostart Acquisition box to automatically start data acquisition each time you load a tube. Be aware that if you use the Autostart Acquisition feature, you must enter a Sample ID prior to loading the sample.

- **NOTE:** If you are using Autostart Acquisition, it is automatically disabled when you click **Settings**, then **Adjust Settings** or **Retrieve Settings**, **Quick Clean**, or **Backflush**. If you click one of these buttons, you must recheck the Autostart Acquisition box to turn on this feature again.

Acquire Control Panel

Sample ID:
Set 4-WLB 2

Sample No:	11	
Total Count:	7627	Events
Count Gate:	No Gate	
% Acquired:	100%	
Conc.:	267.0	Cells/μL
Flow Rate:	0.59	μL/s
Volume:	28.57	μL
Dilution Factor:	1	
Original Volume:	10	mL

Clear Events

Sample Info

AutoSave FCS 2.0 Files saves files in FCS 2.0 format, in addition to the FCS 3.0 files that are saved.

Autostart Acquisition automatically starts acquisition when you load each tube. You do not need to click the Acquire Next Sample button.

Sample Info

- **Sample ID:** Displays the Sample ID for the individual sample. Defaults to the plate well number.
- **Sample No:** Displays the sample #. This number defaults to 1 and advances at the completion of sample acquisition.
- **Total count:** Displays the number of events to acquire. The default is 5000. Total count changes to Gated count if you apply a count gate.
- **Count Gate** allows you to select a gate used as a counting gate. All events above the threshold are saved to the file whether they are in the gate or not.
- **% Acquired:** A progress bar provides an estimate of the target event count during acquisition.
- **Conc.:** Displays the cells/μL that have exceeded the threshold.
- **Flow Rate:** Displays the flow rate selected during the adjust settings step (μL/s).
- **Volume:** Displays the sample volume that is acquired.
- **Dilution Factor:** Displays the dilution factor. The default is 1.
- **Original Volume:** Displays the original sample volume. The default is 10.
- **Clear Events:** Click to clear the display and restart acquisition during adjust settings.

InCyte™ Analysis Screen

The Analysis screen allows you to analyze data from samples that were previously acquired. When you open a data set, the data for the first sample appears. The samples within the file are listed in the Data pane. Click the + in front of the FCS file to display the list of samples. Click any sample to view the data for that sample. You can also click the up/down arrows on the keyboard to select samples.

You can access the Analyse screen by clicking Analyse at the top of the control panel. If you display the Analyse screen at the completion of acquisition, the samples you just ran are listed in the Data pane. Any gates and marker you set during acquisition will appear.

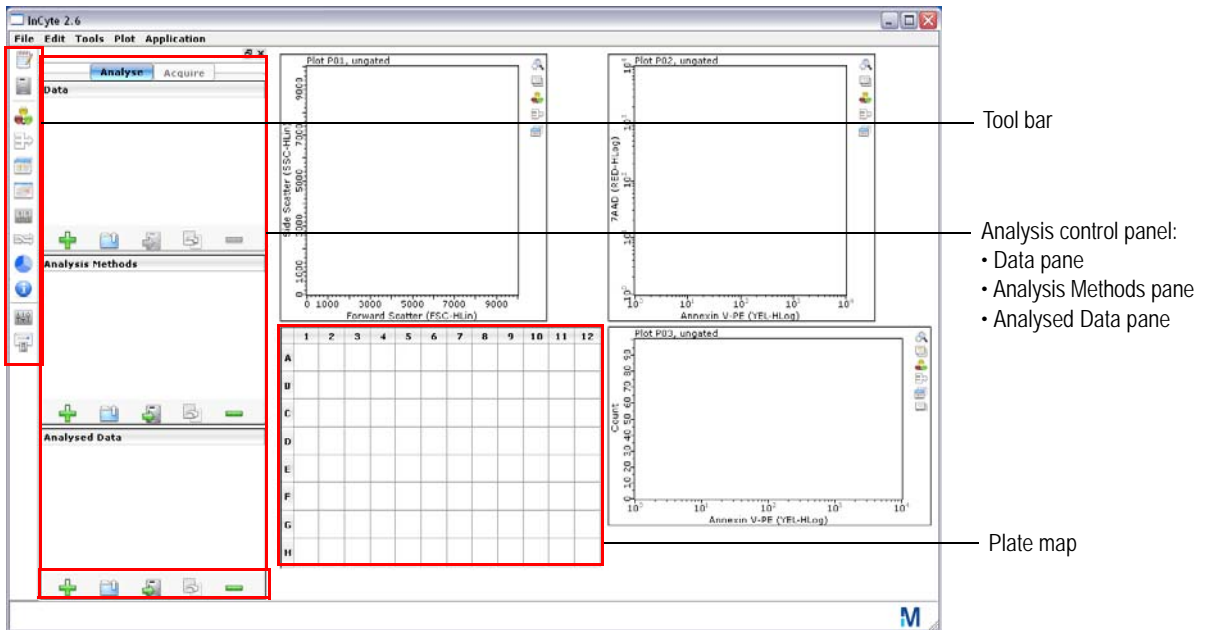

Plots

The plots area of the window displays three plots by default. Use the Plots menu to change the number of plots displayed. Use the tool bar on the right to change the plot type and set regions and gates. For more information on plots, see “Plots” on page 4-2.



Plate Map

The plate map provides a visual representation of the samples contained in the dataset. During analysis, click a well in the plate map to view the data for that sample in the plots. Place your cursor over a well to display the results for that sample. If you are using the HeatMap feature, the plate map provides a visual representation of the relative values for each well, or well-to-well variations in varying shades of blue. For more information on HeatMapping, see “HeatMap” on page 4-38.

Analyse Control Panel

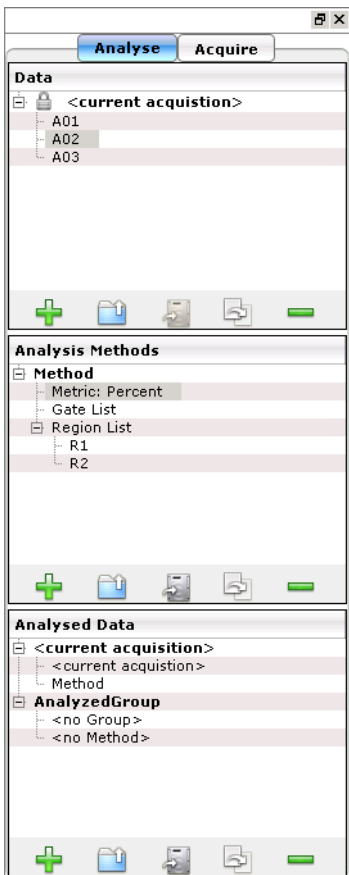

Analysis Buttons

Place the cursor over the icon to display text describing the button. The buttons have the same function for each pane but apply specifically to that pane.



Data

Displays the open data files, as well as any user-created subsets of these files or groups and allows you to select a data set or group for analysis.

Analysis Methods

Displays the Analysis Methods for the current experiment. Each Analysis Method contains a gate list, a region list, and a metric (statistical parameter). InCyte™-acquired files contain Methods. For data files acquired using a program other than InCyte™, you must create a new Method or open an existing Method before you can perform analysis.

Analysed Data

Displays the FCS file and the associated Method. Created by pairing a non-InCyte™-acquired data file with a new or existing Method during analysis, or created automatically during acquisition using InCyte™.

Exiting the Assay

Before quitting the software, be sure to save your current analysis using the Save Analysed Group icon in the Analysed Data pane.

- 1 To quit InCyte™ and return to the guavaSoft main menu, select **Quit** from the File menu.
- 2 Select **Yes** in the confirmation dialog.

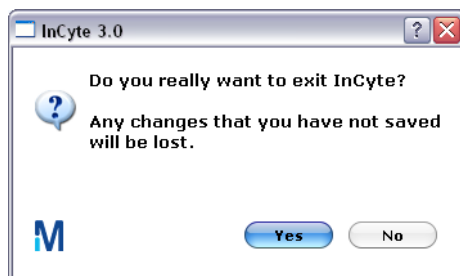

Files

guava InCyte™ automatically saves a flow cytometry standard (FCS) 3.0 data file, which contains the data for all samples within a data set.

Additionally, you can optionally choose to save (or export) the following files:

- a separate Method file
- a separate instrument settings file
- FCS 2.0 or 3.0 files for individual samples for analysis using third-party analysis programs
- list-mode data files

For information on exporting FCS 2.0, 3.0, and list-mode files, see “Exporting Results” on page 4-33.

- **NOTE:** To keep your computer performing optimally, periodically clear old files from your hard drive by archiving the files to a back-up storage location.

Flow Cytometry Standard (FCS) 3.0 Data Files

InCyte™ saves a single FCS file containing all the samples within a data set. The extension .fcs is automatically appended to the file name.

FCS files are data files saved in a format compatible with standard flow cytometry analysis applications as defined by the Society for Analytical Cytology [*Cytometry*, 1990:11(3);323–332]. One FCS 3.0 file is saved for all samples acquired within a data set.

- **NOTE:** Always save guavaSoft™ software’s data files directly to the laptop’s hard drive during acquisition. Saving acquisition data to an outside network may result in data loss. You may copy the file(s) to another location when acquisition is complete.

Method Files

A Method contain all the analysis components (gates, regions, markers, plots, parameters, and statistical setup). When you acquire data using InCyte™, Methods are part of the FCS file. Methods can also be saved to a separate file (.gsy). Data files acquired using a program other than InCyte™ will not have Methods associated with them.

Instrument Settings Files

Instrument settings are automatically saved with the FCS file. You can also save instrument settings to a separate file. The extension .GST is automatically appended to the file name you enter. For more information on instrument settings, see “Saving Instrument Settings” on page 1-23.

Appending and Overwriting Existing Files

If you select the name of an existing dataset name at the start of acquisition, you will be prompted to either append or overwrite it. If you append, the sample number defaults to the next available number in the existing data file.

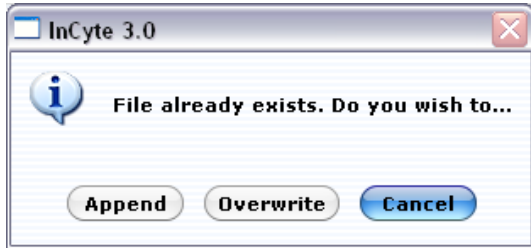

If you append data to an existing file, the instrument settings and analysis gates and markers are automatically updated to reflect the settings for the last sample in the file.

- **NOTE:** Your system administrator may have configured guavaSoft™ software to disable appending and/or overwriting files. If appending only is disabled, you may create a new file or overwrite an existing file. If overwriting only is disabled, you may create a new file or append to a copy of an existing file. If both appending and overwriting are disabled, you must create a new file.

Event Log

Each time you run an assay, guavaSoft™ software saves a log containing a list of all events that occurred during the assay. This information is contained within the FCS data file. To view this list, click the Event Log icon in the tool bar, or **select Tools > Show Event Log**. A list of all events appears with the date and time the event occurred.

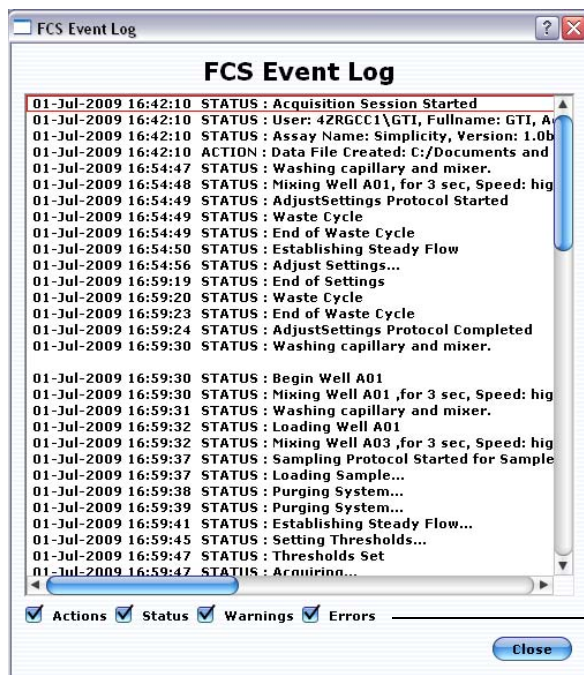

Allows you to filter the list.

You can filter the list to view errors, warnings, statuses, and/or actions. Click the appropriate check box(es) to display the types of events you wish to view.

Every step the instrument performs, independent of the operator (for example, priming, setting thresholds, performing calculations) is logged. Every step the operator performs (for example, key presses, selections, changes to gates and markers, logging comments) is also logged. During data analysis, although changes to settings are logged, the specific details of the change may not be.

If errors or warnings occur during a run, a message appears in red in the status bar indicating that errors/warnings have been logged and how many times they have occurred.

Warnings include:

- *Less than 10 particles/ μ L. Sample is too dilute. Accuracy may be compromised.*
- *More than 500 particles/ μ L. Sample is too concentrated. Please dilute or accuracy may be compromised.*
- *The run timed out before enough events were acquired.*
- *Adjust Settings timed out. Please re-enter Adjust Settings if necessary to complete the instrument set-up.*
- *Maximum velocity exceeded for "x" events (applies only to area/width parameters)*

Errors include:

- *The pump has reached the end of its stroke. You should run this sample again.*
- *Error occurred while trying to generate FCS 2.0 file for sample x.*

To export the log to a text file, click **Export**. Select the storage location and enter a file name. Then, click **Save**.

Instrument Settings

InCyte™ saves the instrument settings for each sample acquired. To access the settings window select the Analysed Group from the Analysed Data pane, then click the Show Instrument Settings tool in the tool bar, or select **Tools > Show Instrument Settings**. In addition to the threshold, gains, and compensation, all of the acquisition information, such as date, time, number of events, total volume, concentration, and flow rate, along with sample-specific information, like sample ID and number, dilution factor, and original volume are saved.

To copy the window to the clipboard, right-click in the window and select **Copy to Clipboard**.

To export the settings to a CSV file for use in a spreadsheet program, click **Export to CSV**. Select the folder where you want to store the file, enter a file name, and click **Save**.

To print the settings, click **Print Stats**.

Sample Number	Sample ID	Number of Events	Termination Count	Count Gate	Dilution Factor	Original Volume	Cells/ μ L	Total Volume (μ L)	Acquisition Time (s)	Date o
13	Set 5-WLB 1	15341	0	All Events	1.00	10.00	4.828e+02	31.78	53.86	09-0C1
14	Set 5-WLB 2	7994	0	All Events	1.00	10.00	2.656e+02	30.10	51.02	09-0C1
15	Set 5-WLB 3	7933	0	All Events	1.00	10.00	2.516e+02	31.53	53.44	09-0C1

Saving Instrument Settings

Although the instrument settings are automatically saved with the FCS file, guavaSoft™ software allows you to save the current instrument settings and analysis gates and markers to a separate file. You must perform the adjust setting step before you can save a settings file. You can recall this file later to:

- download the instrument settings to the guava easyCyte™ System for acquisition
- apply the gates and markers to data during acquisition

1 Click the Save settings button from the Acquisition screen.



2 Enter a name for the file, select the directory where you wish to save it, and click **Save**.

Retrieving Instrument Settings

1 Click the Retrieve settings button from the Acquisition screen.



2 Locate and select the file and click **Open**.

The settings are downloaded to the guava easyCyte™ System.

- **NOTE:** If you retrieve instrument settings after you perform the adjust settings step, you will be prompted to repeat the adjust settings step. You can choose to repeat the adjust settings if you wish.

CHAPTER 2

Getting Started

System Startup and Shutdown

Startup

- 1 Turn on the power conditioner if it is not already on. Once it is powered on, it can remain on.
 - 2 Turn on the laptop computer.
 - 3 Turn on the guava easyCyte™ System.
The power switch is located on the back of the instrument at the lower-right corner (as shown).
 - 4 When the indicator lights turn on, start guavaSoft™ software by double-clicking the **guavaSoft 3.1** application icon on the desktop. You can also click the **Start** button, point to Programs, then Millipore, then guavaSoft 3.1, then click **guavaSoft**.
 - 5 Ensure the cleaning vial is filled with ICF and the waste vial is empty, except for 5 mL of bleach.
- **NOTE:** If the software detects a communication problem with the easyCyte™ System or that the system is not turned on, the following message appears.

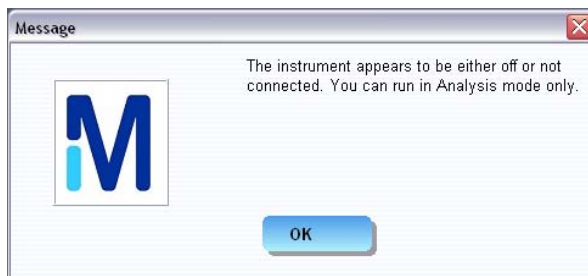
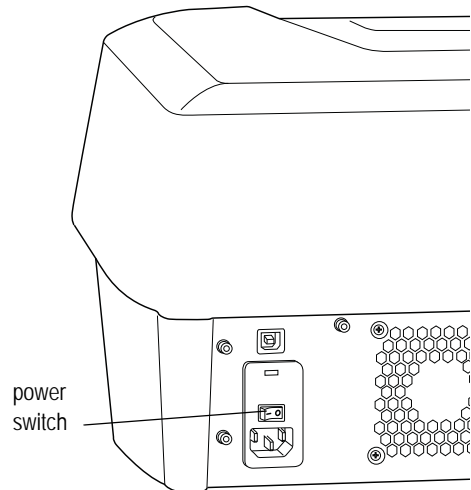

guavaSoft™ will start but you will only be able to access an assay's analysis mode. If you wish to perform acquisition, exit guavaSoft™ software then restart it. If the

message appears again, shut down the system. Ensure that the USB cable between the computer and the instrument is securely connected before restarting the computer. When the computer is finished booting up, turn on the guava easyCyte™ System. When the indicator lights are on, start guavaSoft Software.

Shutdown

Clean the easyCyte™ System and leave a tube of water in the sample loader.

- 1 Run the cleaning procedure at the end of the day. See page 3-2 for complete instructions.
After the cleaning procedure is complete, return to the Main Menu and exit guavaSoft™. Then turn off the instrument and shut down the laptop, in any order.
- 2 Leave the tube of deionized (DI) water loaded on the easyCyte™ System.
The system can be left in this state.
- ◆ **WARNING:** Do not leave Guava® ICF, bleach, or any other cleaning agent on the easyCyte™ System overnight or for an extended period of time. Prolonged exposure to strong oxidizing agents will damage the flow cell. Always leave a tube of DI water on the easyCyte™ System when shutting down the instrument. Change the tube of water regularly to ensure it is clean and free of particles.
- 3 Exit guavaSoft™ software. Do not shut down the guava easyCyte™ System while guavaSoft™ software is running.

Quitting guavaSoft™ Software

- 1 Click **Main Menu** from any of the guava® assay screens, the Guava Clean screen, or the easyCheck screen.
- 2 Click **EXIT** in the lower-left corner of the main menu.

Running the easyCheck™ Procedure

Run the easyCheck™ procedure at the start of each day you use the guava easyCyte™ System to ensure the system is performing properly. easyCheck™ averages the results from three acquisitions of a guava easyCheck™ Bead sample to determine if the results are within the expected range.

■ **NOTE:** Before running the easyCheck™ Procedure, perform a Quick Clean using distilled water to prime the fluid system. If it has been more than a day since you used the system, perform two Quick Cleans using water to prime the fluid system.

- 1 Prepare a 1:20 dilution of guava easyCheck™ Beads. Refer to the *easyCheck™ Kit* package insert for information.
- 2 Click **easyCheck** from the main menu.

- 3 The first time you run the easyCheck™ Procedure, enter the easyCheck™ **Bead Lot #** and **Bead Expiration Date** (found on the easyCheck™ Beads Reagent vial label), and

Expected Particles/mL in the appropriate fields. Thereafter, enter any necessary changes to these values.

Optionally, you may enter the guava easyCheck™ Kit lot number and expiration date (found on the side of the guava easyCheck™ Kit box).

The Expected Particles/mL is typically around 50,000, however check the information card that comes with the easyCheck™ Kit for the actual particle count for each new lot. The particles/mL corresponds to the concentration of beads in your prepared sample where the guava easyCheck™ Bead Reagent was diluted 1:20 with Guava® Check Diluent.

■ **NOTE:** Your system administrator may have configured guavaSoft™ software to require that you enter values in these fields each time you run the easyCheck™ Procedure. If the fields are blank when you access the easyCheck screen, you must enter the current information.

- 4 Mix the easyCheck™ bead sample using a vortex mixer and load the sample on the easyCyte™ System. Click **Run 1st Replicate**.
The system acquires 1000 events and displays the results in the row for Replicate 1. Check the Particle Count in the Sample Information control panel. The FSC, SSC, BLU-V, GRN-V, YEL-V, RED-V, GRN-B, YEL-B, RED-B, NIR-B, RED-R, and NIR-R counts should be within 100 particles of each other when acquisition is complete.
- 5 Remove the sample, mix it well using a vortex mixer to resuspend the beads, and load it on the easyCyte™ System. Click **Run 2nd Replicate**.
The system acquires 1000 events and displays the results in the row for Replicate 2.
- 6 Remove the sample, mix it again to resuspend the beads, and load it on the easyCyte™ System. Click **Run 3rd Replicate**.
The system acquires 1000 events and displays the results in the row for Replicate 3. The % CV, average Particles/mL, and average FSC, optional SSC, and fluorescence intensities for the three replicates are displayed.

■ ACQUISITION NOTES

- The progress bar provides an estimate of the target event count during the acquisition period, which times out after 1 minute.
- If the acquisition rate appears to slow dramatically or there are no particles being acquired, the fluid pathway may be blocked. Click **Abort**, load a tube of deionized (DI) water, then click **Backflush**. When the backflush is complete, load a tube of fresh DI water and click **Quick Clean**. Then, reload the sample and click **Adjust Settings** to start the acquisition process from the beginning.

easyCheck™ Results

The software displays the %CVs and the averages for the particles/mL (bead count), FSC and SSC intensities, and all mean fluorescence intensities (MFIs) for the three replicates.

- If any result for Particles/mL falls outside $\pm 10\%$ of the expected value, the result is outside the acceptable range and appears in red. For example, if the actual particle count is 50,000, the acceptable Particles/mL range ($\pm 10\%$) is 45,000 to 55,000.
- If any result for MFI falls outside $\pm 15\%$ of the expected value, the result is outside the acceptable range.
- If the %CV for Particles/mL is $>10\%$, it appears in red.
- The %CV for FSC and SSC Intensities and MFIs for the three replicates should be $<5\%$.

easyCheck Results													
Sample Information	Particles/mL	FSC Intensity	SSC Intensity	BLU-V MFI	GRN-V MFI	YEL-V MFI	RED-V MFI	GRN-B MFI	YEL-B MFI	RED-B MFI	NIR-B MFI	RED-R MFI	NIR-R MFI
Replicate 1	48913	1232	3427	3090	1021	1029	1001	811	1627	1011	505	1034	2531
Replicate 2	48406	1230	3440	3085	1019	1027	991	810	1625	1009	501	1019	2482
Replicate 3	48710	1230	3431	2982	1027	1021	982	818	1644	1007	475	1015	2377
Average	48676	1230	3433	3052	1022	1025	991	813	1632	1009	493	1023	2463
% CV	0.52%	0.09%	0.19%	1.98%	0.44%	0.41%	0.94%	0.54%	0.63%	0.17%	3.31%	0.98%	3.20%

Refer to the information card that comes with the guava easyCheck™ Kit for the acceptable intensity ranges for each parameter. This information may change from lot to lot.

To monitor the instrument performance, look at the average and %CV values for FSC and SSC Intensity, and BLU-V, GRN-V, YEL-V, RED-V, GRN-B, YEL-B, RED-B, NIR-B, RED-R, and NIR-R MFIs. Refer to “Viewing and Exporting easyCheck™ Results” on page 2-5 for information on displaying past easyCheck™ results.

If the Particles/mL (count) for a replicate or the average falls outside the acceptance range, or if an intensity value is outside the acceptable range, run Quick Clean (refer to page 3-1). Rerun the easyCheck™ Procedure after cleaning is complete. If values continue to fall outside the acceptance range, refer to “easyCheck™ Procedure Troubleshooting” on page 2-8, for more information.

If the signal intensity for any of these parameters shows significant drift over time beyond the range listed, and this change is not correlated to a change in the bead lot, a new flow cell, or instrument service, contact EMD Millipore.

Viewing and Exporting easyCheck™ Results

To display a history of all easyCheck™ runs and view the results for individual runs, click Show History at the bottom of the easyCheck screen. The History List control panel opens showing a list of all easyCheck™ Procedure runs. To display the results for a particular run, click on the run in the list.

The screenshot shows the 'easyCheck 3.0' software interface. The main window is titled 'Analysis' and contains a 'Main Menu' button and a logo 'M'. On the left, there is a 'Unit Control' panel with 'Sample Information' and 'History List' tabs. Below this is a table with columns 'Date' and 'Lot No.', showing two entries: '14MAY-2014 4534542' and '29JUN-2014 7644'. The 'Date' field is currently set to '14MAY-2014 4534542'. Below the table is a 'Bead Lot #' field with the value '7644' and a 'Bead Expiration Date' field with the value 'June 30 2014'. There is also an 'Expected Particles/mL' field with the value '50000'. The main area displays 'easyCheck Results' in a table format:

Sample Information	Particles/mL	FSC Intensity	SSC Intensity	BLU V MFI	GRN V MFI	YEL V MFI	RED V MFI	GRN B MFI	YEL B MFI	RED B MFI	NIR B MFI	RED R MFI	NIR R MFI
Replicate 1	48913	1232	3427	3090	1021	1029	1001	811	1627	1011	505	1034	2531
Replicate 2	48406	1230	3440	3085	1019	1027	991	810	1625	1009	501	1019	2482
Replicate 3	48710	1230	3431	2982	1027	1021	982	818	1644	1007	475	1015	2377
Average	48676	1230	3433	3052	1022	1025	991	813	1632	1009	493	1023	2463
% CV	0.52%	0.09%	0.19%	1.98%	0.44%	0.41%	0.94%	0.54%	0.63%	0.17%	3.31%	0.98%	3.20%

Below the table, there are several buttons: 'Log Comment', 'View Event Log', 'Show Trend Graph', 'Print Screen', 'Export to Spreadsheet', and 'Export Service Check File'. To the right of these buttons is an 'Info' section with two sub-sections: 'Voltages and Gain' and 'Threshold'. The 'Voltages and Gain' section lists parameters like FSC, SSC, BLU-V, GRN-V, YEL-V, RED-V, GRN-B, YEL-B, RED-B, NIR-B, RED-R, and NIR-R with their respective Voltage and Gain values. The 'Threshold' section lists parameters like FSC, SSC, BLU-V, GRN-V, YEL-V, RED-V, GRN-B, YEL-B, RED-B, NIR-B, RED-R, and NIR-R with their respective Threshold values. At the bottom of the interface, there is a 'Last Guava Check: 14-MAY-2014' and a 'Show History' checkbox. The status bar at the very bottom shows 'User: 42RGCC1G11', 'System Off', and 'No Errors or Warnings'. The bottom right corner of the window displays '00:00 of 00:00'.

Click to display the results for a particular run.

- Click **Log Comment** to enter comments related to the run and save these comments to the event log.

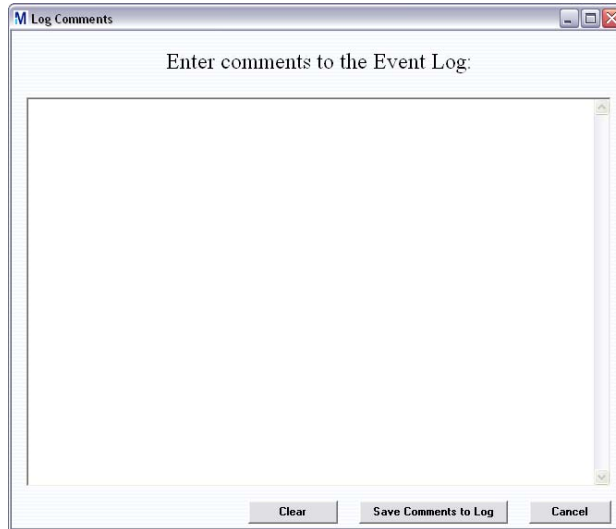

- Click **View Event Log** to display the event log, which lists all errors, warnings, statuses, and actions that occurred during the easyCheck™ run. For more information on the event log, refer to “Event Log” on page 1-21.

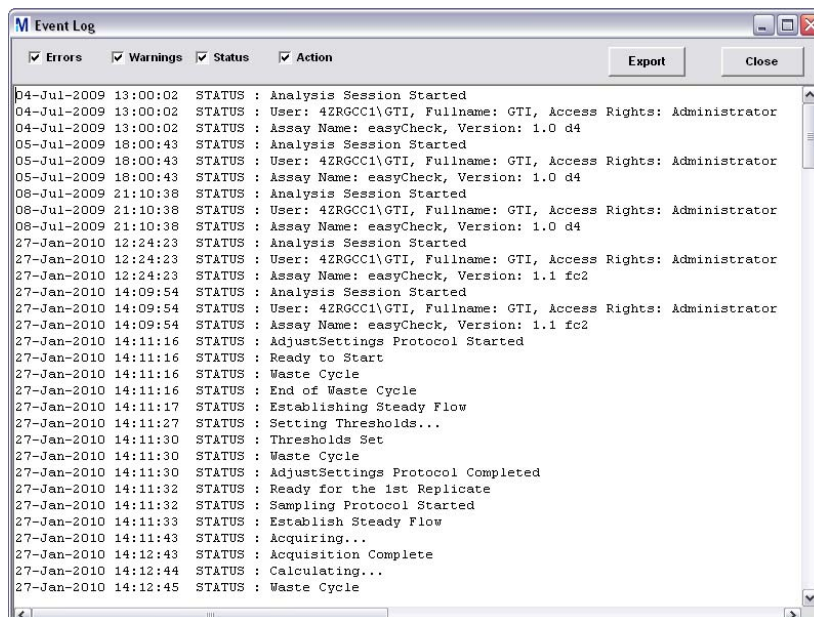

- Click **Show Trend Graph** to display a trend graph of the Particles/mL value from the last 30, 60, or 90 runs. See “Viewing Trend Data” on page 2-7.
- Click **Print Screen** to print the results. A print dialog box appears allowing you to select the printer.
- Click **Export to Spreadsheet** to export the data from all easyCheck™ runs to a spreadsheet file. The file contains the average and %CV for each parameter, as well as the details for each replicate of all runs.

- Click **Export Service Check File** to export the Service Check file. The Service Check file is a zipped file containing the detailed results from the most recent easyCheck™ run. This file is used by service personnel to troubleshoot your system. If your easyCheck™ results continue to fail. Use this export feature to export the file so that you can send it to EMD Millipore.

Viewing Trend Data

To view a trend graph of the Particle/mL data, click Show History at the bottom of the screen, then click **Show Trend Data**.

A trend graph appears showing the Particles/mL results from the last 30, 60, or 90 runs. A data point appears for each of the three replicate values. The date appears for every seventh or eighth time that the easyCheck™ Procedure was run.

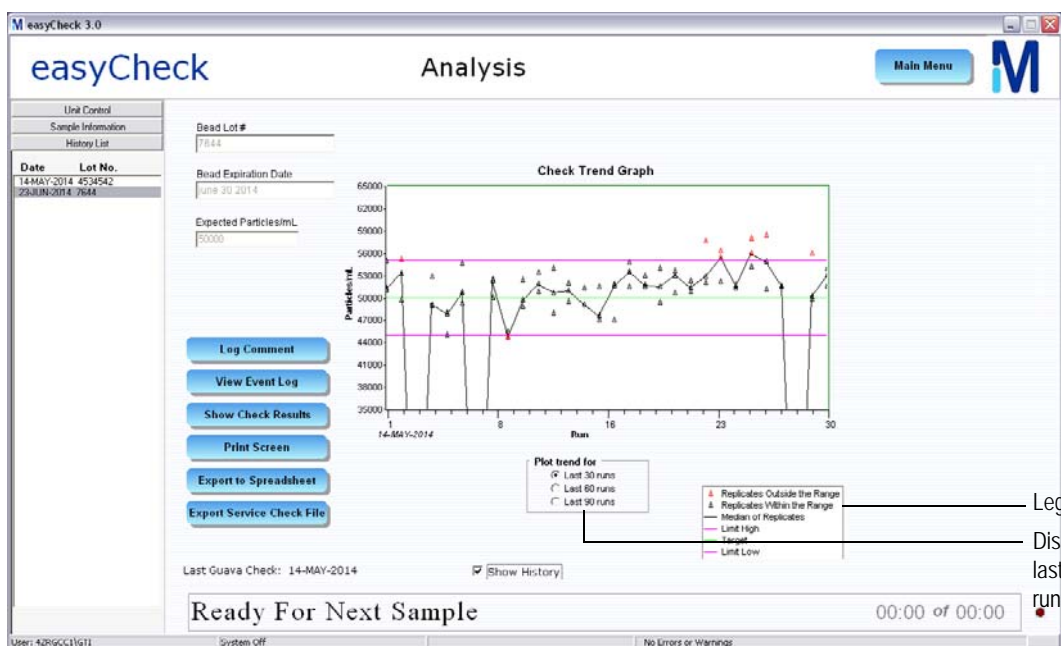

Legend
Display data from last 30, 60, or 90 runs.

A legend in the lower-right corner of the window lists the information found on the graph. A description of the items in the legend appears in the following table.

Legend Item	Description
Replicates Outside Range	data point appears as a red triangle (value falls outside the high or low, 10% limit lines)
Replicates Within Range	data point appears as a black triangle
Median of Replicates	a black line connects the median values from each triplicate
Limit High	pink line that appears 10% above expected particle count
Target	green line at the expected particle count entered
Limit Low	pink line that appears 10% below expected particle count

easyCheck™ Procedure Troubleshooting

Problem	Possible Cause	Solutions
No event counts appear for RED-R and NIR-R.	<ol style="list-style-type: none"> 1. Wrong beads used. 2. Red laser not operating or problem with the signal. 	<ol style="list-style-type: none"> 1. Use easyCheck™ beads. Do not use Guava® Check beads. 2. Contact EMD Millipore Technical Support.
One or more Particles/mL results falls outside the acceptance range (appears in red).	<ol style="list-style-type: none"> 1. System is not clean. 2. Incorrect information entered in easyCheck™ fields. 3. Bead suspension incorrectly prepared. 	<ol style="list-style-type: none"> 1. Run Quick Clean. If results are still outside range, run Clean Only. 2. Ensure correct Bead Lot # and Expected Particles/mL are entered. Refer to page 2-3 for information. 3. Prepare fresh bead sample and rerun easyCheck™ Procedure. Refer to <i>easyCheck™ Kit</i> package insert for preparation instructions.
FSC, SSC, GRN-B, YEL-B, RED-B, NIR-B, RED-R, and/or NIR-R intensity is >10% outside the acceptable range.	<ol style="list-style-type: none"> 1. System is not clean. 2. Problem with detector or laser. 	<ol style="list-style-type: none"> 1. Run Quick Clean. If results are still outside range, run Guava® Clean. 2. If problem persists, contact EMD Millipore Technical Support.
Particle counts for FSC, SSC, GRN-B, YEL-B, RED-B, NIR-B, RED-R, and/or NIR-R intensity is not within 100 events of each other.	<ol style="list-style-type: none"> 1. If FSC count is low, capillary may not be seated correctly. 2. If any of the counts is low, possible problem with detector. 	<ol style="list-style-type: none"> 1. Remove metal plate. Unscrew tubing from top of flow cell and firmly push down on top of flow cell assembly. If problem persists, contact EMD Millipore Technical Support. 2. Rerun easyCheck™ Procedure. If counts are still low, contact EMD Millipore Technical Support.

Problem	Possible Cause	Solutions
Few events, as indicated in Particle Count section of Sample Information control panel.	<ol style="list-style-type: none"> 1. Clogged flow cell. 2. Insufficient sample volume. 3. Beads in suspension have settled. 	<ol style="list-style-type: none"> 1. Remove sample, load bleach, click Backflush. Follow with Quick Clean using DI water. 2. Minimum sample volume is 90 μL. 3. Click Abort. Remove sample, mix, reload, and reacquire.
No events, as indicated in Particle Count section of Sample Information control panel.	<ol style="list-style-type: none"> 1. Sample tube not properly loaded. 2. Insufficient sample volume. 3. No beads in sample. 4. Clogged flow cell. 5. Broken flow cell. 6. Sample pump not working. 7. Laser is not operational. 8. Loose fitting on minstac tubing (under metal plate). 	<ol style="list-style-type: none"> 1. Ensure tube is loaded and loader assembly is up. 2. Minimum sample volume is 90 μL. 3. Ensure correct sample is loaded. 4. Remove sample, load bleach, click Backflush. Follow with Quick Clean using DI water. 5. Remove flow cell and inspect for damage. Replace, if necessary. 6. Run Quick Clean and watch for fluid in waste vial. 7. Contact EMD Millipore Technical Support. 8. Ensure tubing connector is secure.
<p>Message: <i>The login user does NOT have read/write permission to the file GuavaCheckLog.csv in the Log folder. Contact the system administrator for assistance.</i></p>	The user was not assigned access control to the system.	Contact your system administrator for user access to the software.

CHAPTER 3

Cleaning and Maintenance

Depending on the type of cleaning you wish to do, guavaSoft™ software offers different cleaning options—Quick Clean, which you can use as often as you like throughout an assay or anytime, and Guava® Clean, a more thorough cleaning, which you run at the start and end of each day to thoroughly clean the fluid system.

To clean the outside of the instrument, wipe it down with a soft cloth moistened with 70% alcohol. Follow with a cloth moistened with water.

- ◆ **WARNING:** To avoid exposure to laser radiation or electric shock, DO NOT open the easyCyte™ System or attempt to perform any internal maintenance. There are no user serviceable parts.

Running Quick Clean

Quick Clean is a short cleaning cycle that allows you to clean the fluid system during and after an assay, or as often as you like throughout the day. If you are running lots of samples or particularly dirty or adherent cells, run Quick Clean frequently. The Quick Clean feature, which is accessible from the easyCheck™ and all guavaSoft™ Assay screens, prompts you for a tube of cleaning solution.

- 1 Load one of the following solutions on the easyCyte™ System:
 - deionized water to quickly flush out the fluid system
 - undiluted Guava® ICF to clean the system, followed by water to rinse
 - a 10% bleach solution in Guava® ICF (1 part bleach in 9 parts Guava® ICF; for example, 100 µL bleach plus 900 µL Guava® ICF) to clean and sanitize, followed by water to rinse
- 2 Click **Quick Clean** from any of the guava® assay screens. From guava InCyte™, click the Capillary Cleaning Tools button and select **Quick Clean**.
A message appears prompting you to load a tube of cleaning solution. Ensure the tube is loaded and click **OK**.
The solution is pumped through the system for approximately 30 seconds.
- 3 If you used water, you are finished. If you used Guava® ICF, either straight or with bleach, load a tube of water and click **Quick Clean** again to rinse.

You may continue running samples, or leave the tube of water on the easyCyte™ System until you are ready to use the system again.

Running Guava[®] Clean

Run Guava[®] Clean to clean the instrument at the beginning and end of the day, as well as between assays if a thorough cleaning is needed. You can also use Guava[®] Clean to prime the fluid system or if you suspect there is air in the fluid lines. Fill the cleaning vial and sample tube with water and run Guava[®] Clean to prime. Guava[®] Clean takes approximately 15 minutes to complete. While it is running, the lasers are turned off.

Always leave a tube of deionized water on the easyCyte[™] System at the end of the cleaning cycle.

- 1 Click **Cleaning** from the main menu.
The Guava Clean screen appears.

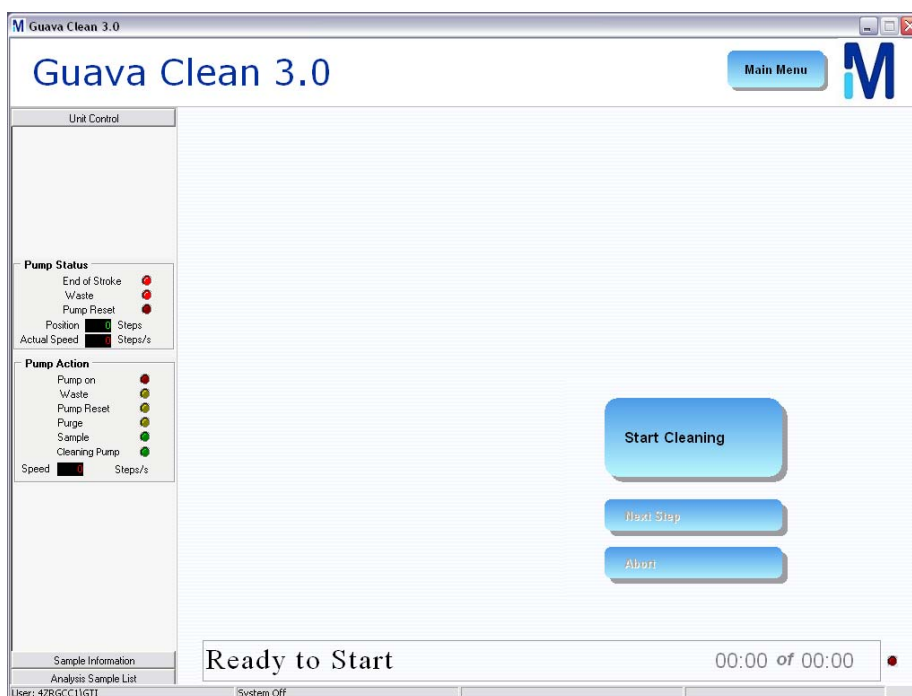

- 2 Click **Start Cleaning**.
A dialog box appears, prompting you to load a tube of water.

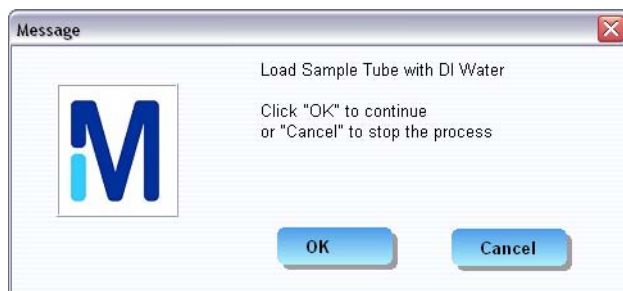

- 3 Load a 1.5-mL tube filled with DI water in the sample loader and click **OK**.

After approximately 4 minutes, a message appears prompting you to load a tube of cleaning solution.

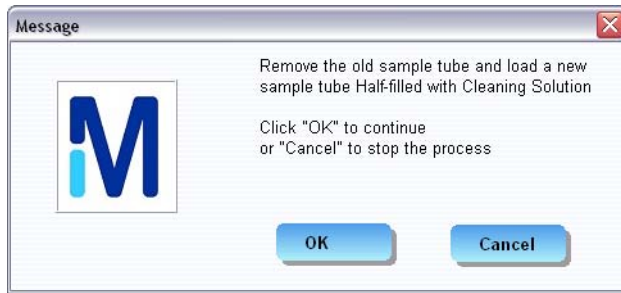

- 4 Load a tube half-filled with a 10% bleach solution in Guava[®] ICF (1 part 100% bleach in 9 parts Guava[®] ICF) and click **OK**.
After approximately 3 minutes, a message appears prompting you to load a tube of clean water.

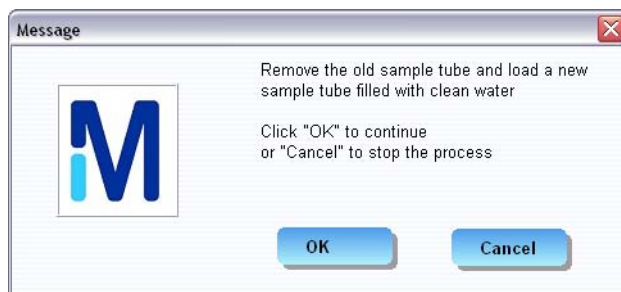

- 5 Load a tube of fresh water and click **OK**.
If you notice air moving through the cleaning vial tubing, when the cleaning cycle is complete, check the connectors holding the tubing to ensure they are tight.
After approximately 5 minutes, a message appears prompting you to load the tube of clean water.
 - 6 If you are shutting down the instrument, place a tube of deionized (DI) water on the easyCyte[™] System. Return to the Main Menu and exit guavaSoft[™]. Then turn off the instrument and shut down the laptop, in any order.
- ◆ **WARNING:** Do not leave Guava[®] ICF, bleach, or any other cleaning agent on the easyCyte[™] System overnight or for an extended period of time. Prolonged exposure to strong oxidizing agents will damage the flow cell. Always leave a tube of deionized water on the easyCyte[™] System after cleaning and when shutting down the system. Change the tube of water regularly to ensure it is clean and free of particles.

Backflushing the Fluid System

The backflush feature reverses the flow of fluid out of the flow cell. Click the **Backflush** button, located on each assay screen and the easyCheck screen, when you suspect that the fluid pathway is clogged or blocked.

- 1 If you suspect a clog, click **Abort**.
- 2 Remove the sample tube and load a tube of 20% bleach.
 - **NOTE:** If you are running the easyCheck™ Procedure, use water when backflushing the system.
- 3 Click **Backflush** from any of the guava® assay screens. From guava InCyte™, click the Capillary Cleaning Tools button and select **Backflush**.
A message appears instructing you to load a tube of water or bleach. Ensure the tube is loaded and click **OK**.
- 4 If you used bleach in step 2, load a tube of deionized water and click **Quick Clean** to rinse any residual bleach from the capillary.
- 5 Throw out the tube you used in step 2, as it may contain debris from the backflush.
- 6 Replace the sample and click **Acquire Next Sample** (If you are running the easyCheck™ Procedure, start from the adjust settings step).

Filling the Cleaning Solution Vial

Fill the cleaning solution vial with Guava® ICF when it is approximately 1/4 full. The cleaning solution is aspirated through the tubing in the vial. Do not allow the vial to empty. Check it frequently to ensure it does not run dry. This will create air bubbles in the fluid system and require that you prime the system with water. One vial of cleaning solution will allow you to perform approximately 15 cleaning cycles.

- 1 Gently pull up on the vial to remove it from the bracket.

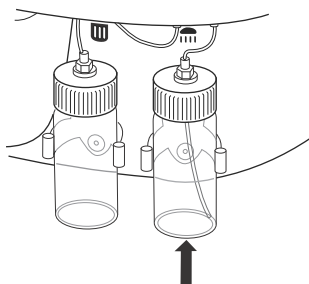

Slide cleaning solution vial out of bracket.

- 2 Unscrew the vial from the cap.

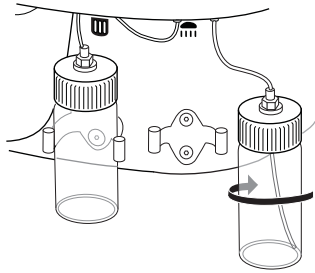

Unscrew cleaning solution vial.

- 3 Fill the vial with Guava[®] ICF to just below the bottom of the cap. Do not overfill the vial.
- 4 Replace the vial on the cap assembly and install the vial on the system. Ensure the tubing that goes into the vial is still attached to the cap.

Emptying the Waste Vial

Empty the waste collection vial at the end of each day, or as needed.

- ◆ **WARNING:** Handle all biological specimens and materials they come in contact with as if capable of transmitting infection. Dispose of these materials using proper precautions in accordance with federal, state, and local regulations.

- 1 Gently pull up on the vial to remove it from the bracket.

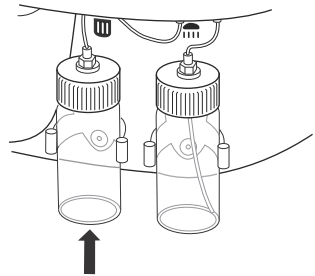

Slide waste vial out of bracket.

- 2 Unscrew the vial from the cap.

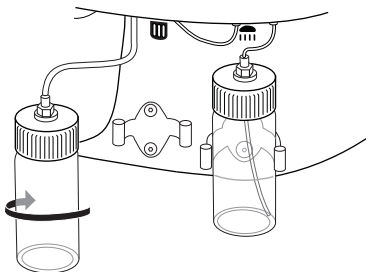

Unscrew waste vial.

- **NOTE:** Fluid may seep from the cap while it is disconnected from the vial. To prevent waste fluid from dripping on the work surface, place the cap in a small container or on an disposable, absorbent pad.
 - **NOTE:** If you notice a leak on top of the waste vial cap, tighten the connector on the cap.
- 3 Empty the contents according to your local and state biohazardous waste disposal guidelines.
 - 4 Rinse the waste vial with water.
 - 5 Add approximately 5 mL of bleach to the waste vial, replace the vial on the cap assembly and install the vial on the easyCyte™ System.

Cleaning the Flow Cell

About the Flow Cell

The flow cell assembly consists of the shuttle, the capillary, and the minstac tubing. The shuttle houses the optical window, where the laser beam intersects the sample. When handling the flow cell assembly, grasp it towards the top of the shuttle, where the minstac tubing is attached, to avoid getting fingerprints on the optics window. When installing a flow cell, ensure this tubing connection is tight to avoid fluid leaking from the top of the shuttle.

A flow cell removal tool is provided and can be used to remove the flow cell. A tightening tool is also provided and can be used to tighten the minstac tubing to the instrument during flow cell installation.

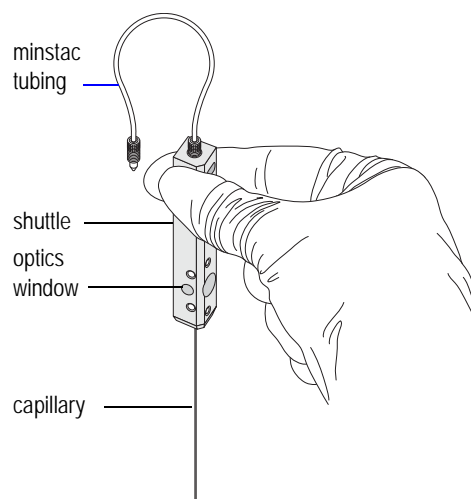

Using the Syringe Tool to Clean the Flow Cell Assembly

Use the syringe assembly tool to clean the flow cell. When removing the flow cell, handle it with care. The capillary tube is fragile; avoid touching it unnecessarily. Do not force the flow cell into the receptacle. However, slight pressure may be required to properly seat the flow cell once it has been inserted into the receptacle.

- ◆ **WARNING:** To avoid exposure to laser radiation, turn off the power to the easyCyte™ System before attempting to remove the flow cell.
- 1 Lower the sample loader arm.
 - 2 Remove the metal plate from the top of the instrument.

- 3 Remove the tubing from the clamp and disconnect it from the instrument.

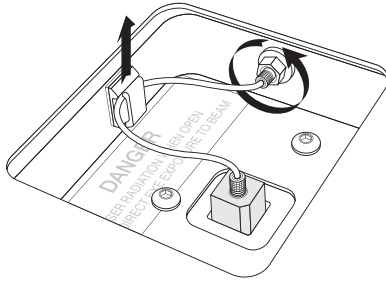

- 4 Remove the flow cell by grasping it at the top with your fingers and pulling straight up. Do not pull on the tubing. You can also use the flow cell removal tool to remove the flow cell.
- Grasp the flow cell with the removal tool by placing the clamps into the cutouts at the top of the flow cell, as shown.
 - Pull the tool straight up to remove the flow cell.

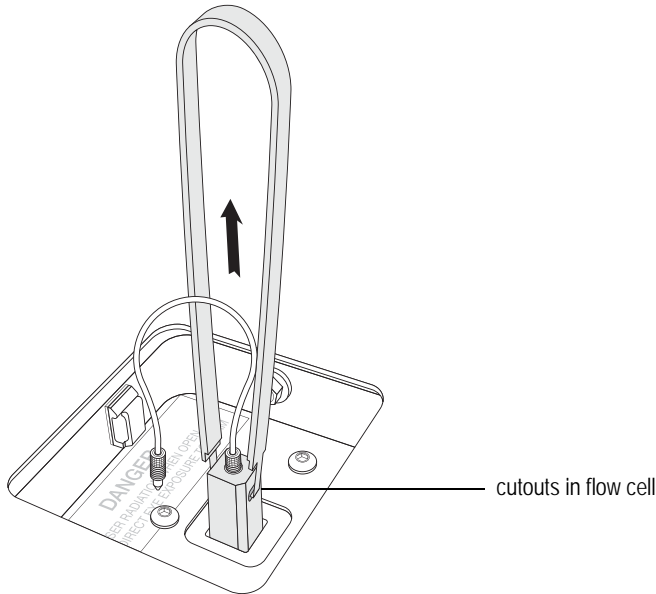

- 5 Fill the syringe cleaning tool with water or Guava[®] ICF. Connect the syringe to the minstac tubing on the flow cell. Ensure the fitting is tight.

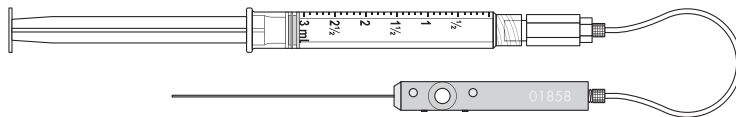

- 6 Use a Kimwipe[®] wipe to hold the flow cell at the top of the shuttle to capture fluid that may leak. Apply gentle, steady pressure to the plunger and watch as the fluid flows from the tip of the capillary.
- Make sure the fluid stream is straight. If it is not straight, the tip of the flow cell may be chipped or there may be a partial clog in the flow cell.

- Check the capillary to ensure there are no leaks along the length of it.
- Make sure fluid is not leaking where the tubing is connected at the top of the flow cell.

7 Unscrew the syringe from the minstac tubing. Leave the minstac tubing attached to the flow cell.

8 If you noticed leaks at the tubing connection and you have the tool shown at the right, use the tool to tighten the tubing connection. A tight connection ensures that fluid will not leak from the top of the flow cell.

- Point the tool's threaded stem up (away from the flow cell) and insert the tubing connector into clamp end of the removal tool.
- Squeeze the handles of the tool to secure the flow cell, while tightening.
- Tightening is sufficient when you feel the tool slipping on the connector.

If you don't have the tool shown at the right, use your fingers to hand-tighten the tubing connection.

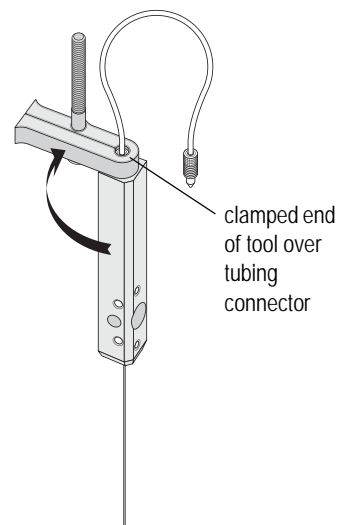

9 Use a Kimwipe® wipe to dry the end of the tubing that you disconnected from the syringe.

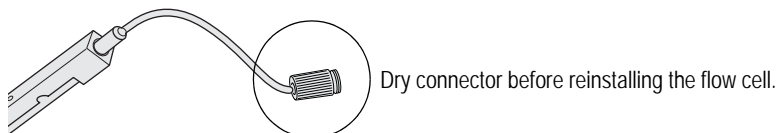

10 If the flow cell is clean and intact, reinstall it. If it is damaged or not functioning properly, discard it and replace it with a new flow cell.

- Install the clean (or new) flow cell by correctly positioning it vertically above the instrument and carefully lowering it into the receptacle. The flow cell fits only one way into the receptacle. Avoid bumping the capillary as you install it.

- Use your fingers to push down on the top of the flow cell on either side of the tubing until the flow cell clicks into place. Do not press down on the tubing at the top of the shuttle. Press down until the flow cell stops and won't go any farther.

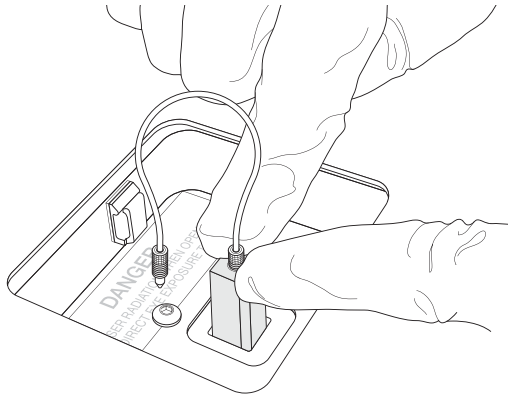

- 11 Connect the tubing to the instrument. Make sure the tubing is screwed on tightly. If necessary, use the tightening tool. Then insert the tubing into the clamp.

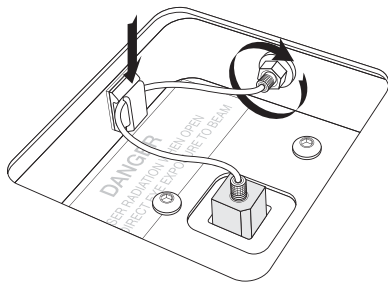

- 12 Ensure that the cleaning solution vial is full, then run Quick Clean to prime the system. If starting the instrument after it has been shut down, run Guava[®] Clean to prime. Watch the tubing during the Quick Clean to ensure no bubbles appear in the tubing.
- 13 To ensure that the flow cell was correctly installed, run the easyCheck[™] procedure. While the first replicate is being acquired, watch for bubbles in the minstac tubing. If bubbles or leaks are visible, the tubing may not be adequately tightened.

Replacing the Flow Cell

You can replace the flow cell if it becomes damaged or clogged so severely that backflushing and cleaning the system do not fix the problem. When replacing the new flow cell, handle it with care. The capillary tube is fragile; avoid touching it unnecessarily. Do not force the flow cell into the receptacle.

◆ **WARNING:** To avoid exposure to laser radiation, turn off the power to the easyCyte™ System before attempting to remove the flow cell.

- 1 Lower the sample loader arm.
- 2 Remove the metal plate from the top of the instrument.
- 3 Remove the minstac tubing from the clamp and disconnect it from the instrument.

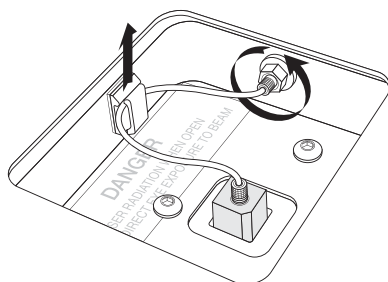

- 4 Remove the flow cell by grasping it at the top with your fingers and pulling straight up. Do not pull up on the tubing.
You can also use the flow cell removal tool to remove the flow cell.
 - Grasp the flow cell with the removal tool by placing the clamps into the cutouts at the top of the flow cell, as shown.
 - Pull the tool straight up to remove the flow cell.

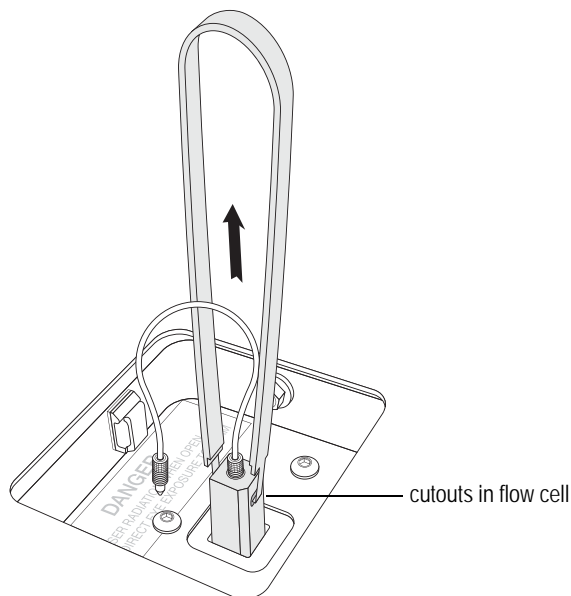

- 5 Install a new flow cell by correctly positioning it above the instrument and carefully lowering it into the receptacle. The flow cell fits only one way into the receptacle. Keep the flow cell completely vertical and avoid bumping the capillary against the instrument or sides of the receptacle. Use your fingers to press down on the top of the flow cell on either side of the tubing until the flow cell clicks into place. Do not press down on the tubing at the top of the shuttle.

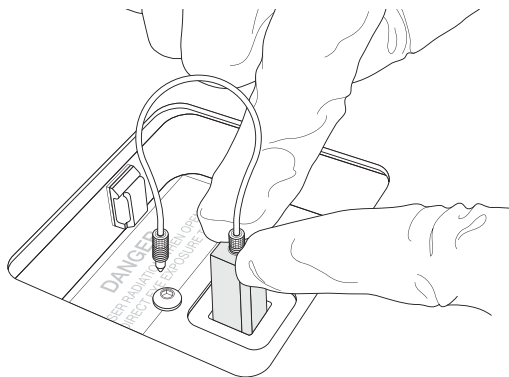

- 6 Connect the tubing to the instrument, then insert the tubing into the clamp.

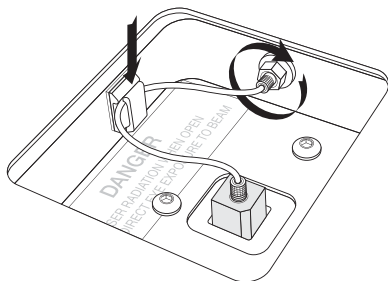

- 7 Ensure that the cleaning solution vial is full, then run Quick Clean to prime the system. If starting the instrument after it has been shut down, run Guava[®] Clean to prime.
- 8 To ensure that the flow cell was correctly installed, run the easyCheck[™] procedure. While the first replicate is being acquired, watch for bubbles in the minstac tubing. If bubbles or leaks are visible, the tubing may not be adequately tightened.

Replacing the Fuses

The AC fuse is located on the rear panel to the right of the AC power cord connector.

- ◆ **WARNING:** Turn off the power switch at the back of the instrument and disconnect the power cord.

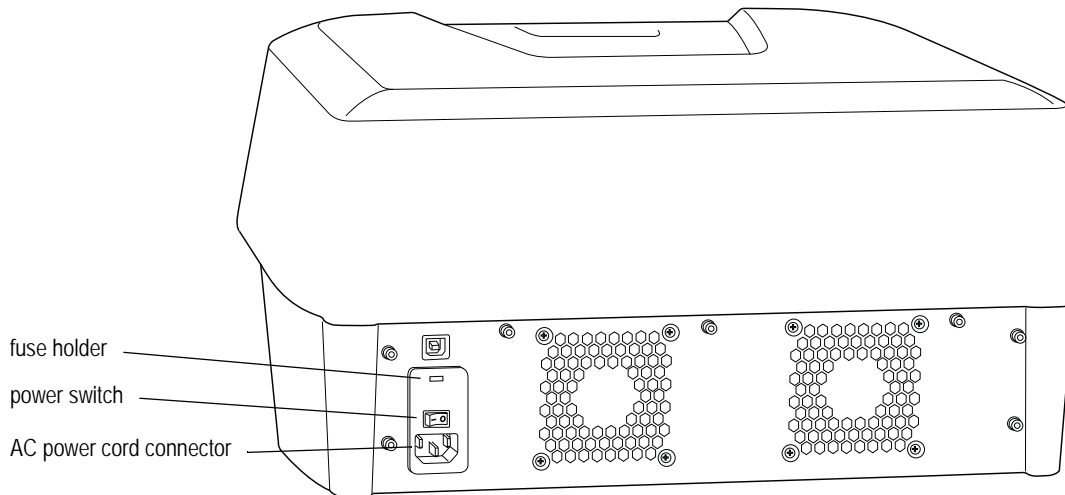

- 1 Remove the fuse holder cover using a small screwdriver and pivot to expose the fuse carrier.
- 2 Pull out the fuse carrier.
- 3 Carefully remove the fuses and replace with new fuses. Use the same type and rating as listed in the Specifications section.
 - **NOTE:** If you have a 110 V supply you will need to replace a single fuse. If you have a 220 V supply you will need to replace two fuses.
- 4 Insert the fuse carrier back into the fuse holder. The fuses will face the inside of the fuse holder.
- 5 Replace the fuse holder cover.
- 6 Reconnect the power cord and turn on the main power switch.

Returning the System for Service

Contact EMD Millipore Technical Support for the Decontamination Form and instructions. The form must be returned via e-mail before you can return the instrument. A return authorization (RMA) number will be issued to you. Write this number on the outside of the shipping box. If you did not save the original shipping box, you can order one (see Appendix C: Ordering Information).

- 1 Perform the Guava[®] Clean procedure (see “Running Guava[®] Clean” on page 3-2).
- 2 Clean and disinfect the cleaning solution vial and waste vial.
- 3 Power off the laptop and instrument.
- 4 Disconnect the laptop, instrument, and power conditioner.
- 5 Pack the laptop and power cord in the laptop box.
- 6 Pack the USB cable, extension cable, and power cord in the accessory box.
- 7 Remove the flow cell from the instrument. Use the syringe cleaning tool to flush it with water, and then flush it with air. Store the flow cell in the capillary box. For information on cleaning the capillary, see “Using the Syringe Tool to Clean the Flow Cell Assembly” on page 3-6.
- 8 Tape the capillary hatch closed.
- 9 Place the instrument in the shipping bag and secure the bag. Be sure to include the cleaning solution and waste vials.
- 10 Place the instrument in the shipping box. Always use two people to lift the instrument.
- 11 Place the blue shipping foam over instrument. Place the accessory box on top.
- 12 Place the cover on the box and insert the white locks into the holes.

CHAPTER 4

guava InCyte™ Assay

Introduction

guava InCyte™ was developed to be an open assay module providing all the basic tools for sample acquisition and data analysis. The guava InCyte™ module allows you to acquire and analyze up to ten fluorescence parameters in combination with forward scatter (FSC) and side scatter (SSC), as well as area, width, and time.

The instrument is configured to detect the following fluorochromes or fluorochromes with similar fluorescence. The filter is listed first, followed by the laser. For example, Blue-Violet (BLU-V) is the filter for the blue fluorescence emission off the violet laser.

For a complete list of the fluorochromes compatible with each laser, see "Fluorochromes" in the Specifications section.

Filters off the violet laser:

- Blue-Violet (BLU-V) parameter – DAPI, Brilliant Violet 421, Pacific Blue, Cascade Blue, or Alexa Fluor® 405
- Green-Violet (GRN-V) parameter – Brilliant Violet 510 or Pacific Green
- Yellow-Violet (YEL-V) parameter – Brilliant Violet 605 or QDot 565
- Red-Violet (RED-V) parameter – Brilliant Violet 650 or eFluor 650

Filters off the blue laser:

- Green-Blue (GRN-B) parameter – FITC, GFP, or Alexa Fluor® CF-488
- Yellow-Blue (YEL-B) parameter – Phycoerythrin (PE)-based, Cy3, Alexa Fluor® 532, propidium iodide (PI), TRITC, and DS Red reagents
- Red-Blue (RED-B) parameter – PE-Cy5, PerCP, 7-AAD, PE-Cy5.5, and PI
- NIR-Blue (NIR-B) parameter – PE-Cy7

Filters off the red laser:

- Red-Red (RED-R) parameter – Allophycocyanin (APC), Cy5, or Alexa Fluor® CF-647.
- NIR-Red (NIR-R) parameter – APC-Cy7, or APC-Alexa Fluor® 750

InCyte™ Application Window

The application window opens displaying three plots. A tool bar at the left edge of the window allows you to access most of the application controls (see Figure 4-1). You can find these same options in the Tools menu in the menu bar.

The control panel displays the controls for acquiring and analyzing data. Click **Analyze** or **Acquire** to display the desired control panel. Click in the top bar (above the Analyze and Acquire buttons) to drag the floating control panel to any area of the screen or dock it on the right side of the window. To redock it on the left, double-click the bar at the top of the panel. To hide the control panel, click the X in the top-right corner. To redisplay the panel, choose **Tools > Show/Hide Acquisition Controls** from the menu bar, or click the *Acquisition Controls* icon in the tool bar on the left edge of the application window. Place your cursor over any button in the Analyze or Acquire button panel to see text describing the button.

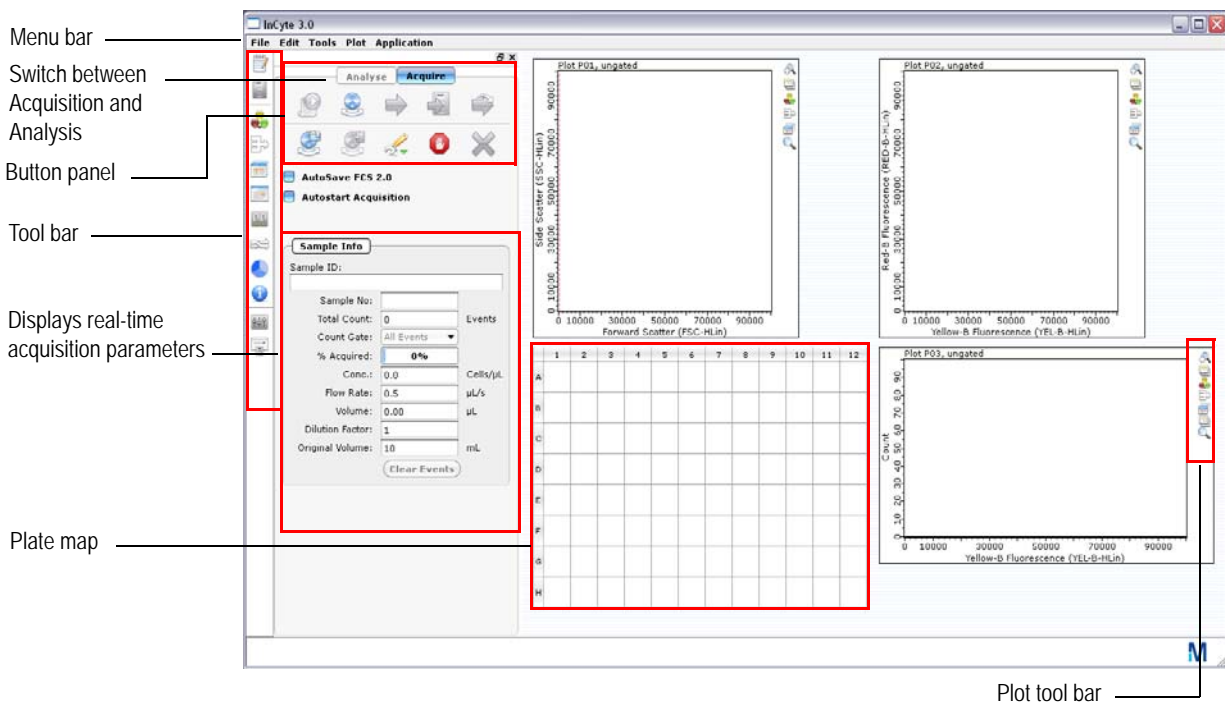

Figure 4-1 InCyte™ application window – Acquisition screen

Plots

Use the Plot menu in the menu bar to set up the plot layout. Select the number of plots to display (2x2 to 5x5 represents the number of plots displayed down vs across). Up to 24 plots can be displayed at one time.

Plot Tool Bar

- Use the *Undock* icon to detach and enlarge the plot. The plot will detach in its own floating window. Drag the bottom-right corner to increase the size of the plot window. Copy the zoomed plot to the clipboard for higher resolution plots. To reattach the plot, click the Undock icon again or the X in the top-right corner.
- Use the *Plot type* icon to select Dot Plot, Histogram, or Contour Plot, and to adjust settings such as smoothing histograms and contours and selecting the dots to display in dot plots. Contour plots can be used only during analysis. See “Changing the Display of Data in Plots” on page 4-3 for information.
- Use the *New region* and *Plot gate* icons to create regions and apply gates, respectively. See “Regions, Gates, and Statistics” on page 4-19.
- *New Stat Marker* is described in “Stat Markers” on page 4-26. *Edit overlay list* is described in “Overlaying Histograms” on page 4-49.
- To change the plot parameters once data is displayed, click the parameter name and select the new parameter from the pop-up menu. To customize a parameter name, see “Changing Parameter Names” on page 4-5.



Forward Scatter (FSC-H)	Lin	Log
Side Scatter (SSC-H)	Lin	Log
Blue-V Fluorescence (BLU-V-H)	Lin	Log
Green-V Fluorescence (GRN-V-H)	Lin	Log
Yellow-V Fluorescence (YEL-V-H)	Lin	Log
Red-V Fluorescence (RED-V-H)	Lin	Log
Green-B Fluorescence (GRN-B-H)	Lin	Log
Yellow-B Fluorescence (YEL-B-H)	Lin	Log
Red-B Fluorescence (RED-B-H)	Lin	Log
Near IR-B Fluorescence (NIR-B-H)	Lin	Log
Red-R Fluorescence (RED-R-H)	Lin	Log
Near IR-R Fluorescence (NIR-R-H)	Lin	Log
Blue-V Fluorescence Area (BLU-V-A)	Lin	Log
Blue-V Width (BLU-V-W)	Lin	Log
Time	Lin	

- To copy a plot to the clipboard, right-click the plot and select **Copy Plot to Clipboard**.
- Use the *Zoom* icon to zoom an area of the plot. Click and drag a rectangle in any direction to encompass the population you wish to zoom in on. To scroll the data in the plot, click the icon, then hold down the Shift key while you click and drag. To unzoom, click the Zoom icon again, then press and hold the Ctrl key while you click anywhere in the plot.

Changing the Display of Data in Plots

You can make the following changes to the display of data in these plots. The settings are saved with the Analysed Group. Click the Plot Type icon in the plot tool bar and select **Plot Settings**.



- Set the number of dots displayed in a dot plot
Use the slider to set the number of dots from 1 to 100%. The default is 100%.

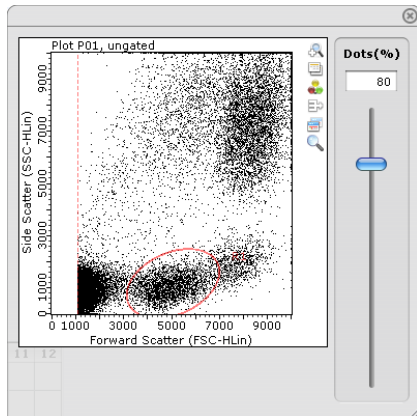

- Smooth histograms
Use the slider to set the amount of smoothing (sigma) from 0 to 5.0, where 0 is no smoothing. The default is 1.5.

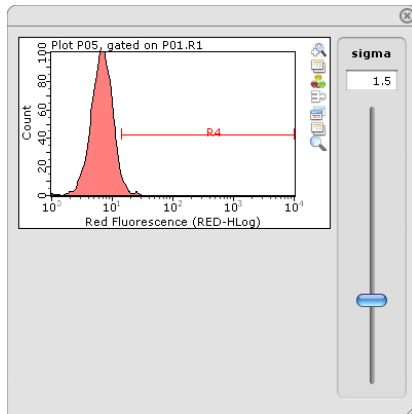

- Smooth contour plots
You can adjust both the number of levels from 5 to 20, and the amount of smoothing (sigma) from 0 to 5.0, where 0 is no smoothing. The defaults are 10 and 1.5, respectively. Contour plots can be created during analysis only.

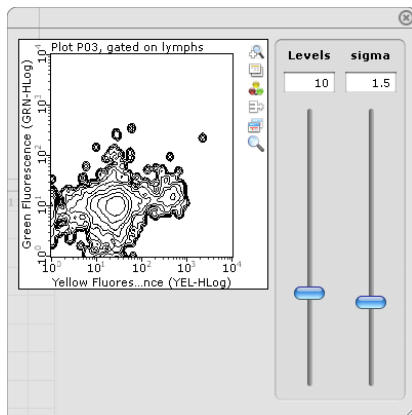

Changing Parameter Names

You can change the default long (or stain) name of any parameter. The short name, for example, GRN-B-H, is fixed and will still appear in the plots in parentheses after the new long name.

- 1 Choose **Application > Change Parameter Names** from the menu bar.

The Parameter Names dialog box appears. Area and width are listed only if they were selected during the adjust settings step prior to acquisition.

- 2 Double-click the existing name in the *Long or Stain Name* text field and type in the new name, or use the tab key to highlight the desired field and begin typing the new name.

The short name will appear in parentheses following the long name under the plots.

- 3 Click **Update**.

	Short Name	Long or Stain Name
1	FSC-H	Forward Scatter
2	SSC-H	Side Scatter
3	BLU-V-H	Blue-V Fluorescence
4	GRN-V-H	Green-V Fluorescence
5	YEL-V-H	Yellow-V Fluorescence
6	RED-V-H	Red-V Fluorescence
7	GRN-B-H	Green-B Fluorescence
8	YEL-B-H	Yellow-B Fluorescence
9	RED-B-H	Red-B Fluorescence
10	NIR-B-H	Near IR-B Fluorescence
11	RED-R-H	Red-R Fluorescence
12	NIR-R-H	Near IR-R Fluorescence
13	BLU-V-A	Blue-V Fluorescence Area
14	BLU-V-W	Blue-V Width
15	TIME	Time

Update Cancel

Pie Legend

The Pie Legend contains the HeatMap legend and the IC-50 application. The HeatMap legend (circle) is used to display the data results for each Analysed Group (data + Method) in the plate map. Use the **Show Pie Legend** icon in the tool bar to display this workspace.

The HeatMap legend shows one sector by default. You can create up to six sectors for six experiments. Each sector will have a data file (or group) paired with an Analysis Method. To divide the legend into multiple sectors click N=2, 3, etc. To clear a sector, right-click it and



select **Clear Sector**. For more information on Heatmapping, see “HeatMap” on page 4-38.

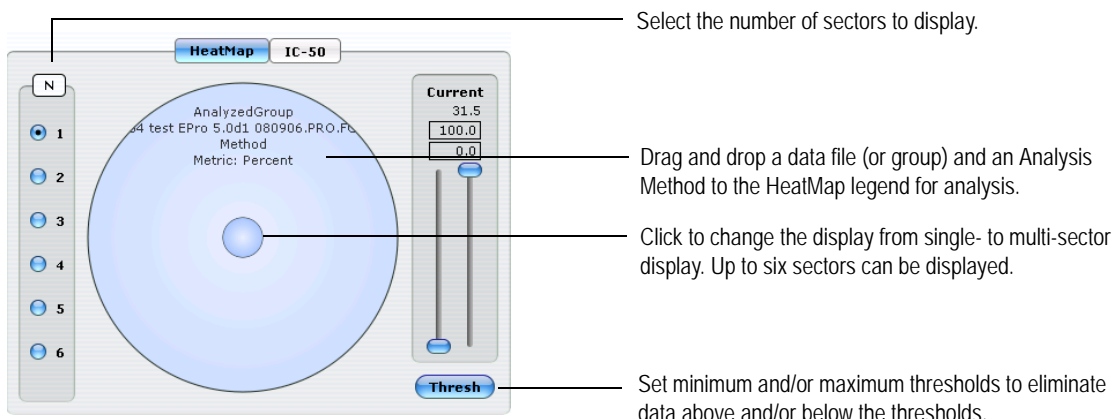

- **N** allows you to select the number of sectors you want to display. Sectors are numbered (1-6) with each new sector entering the upper-left portion of the circle.
- **Threshold** allows you to apply upper and/or lower limits on statistical values to eliminate data above or below the thresholds. The Current panel is only functional when one sector is being displayed, or when multiple sectors are used but the HeatMap legend is in single-mode display. See “Thresholds” on page 4-43 for information.
- The IC-50 application allows you to rapidly convert time course or dose response studies into standard curves for the calculation of compound IC50/EC50 values. See “IC-50/EC-50” on page 4-44 for more information.

guava InCyte™ Sample Acquisition

- 1 Open guavaSoft™ software by double-clicking the guavaSoft™ icon on the desktop.
- 2 Click **InCyte** from your list of Favorites, or select **InCyte™** from the Program Search list and click **Launch**.

The guava InCyte™ window opens in Acquisition mode, if the easyCyte™ System is turned on. The top portion of the control panel contains 10 buttons used to control acquisition, adjust, retrieve and save instrument settings, and select cleaning options.

For information on the control panel, refer to “Acquire Control Panel” on page 1-17.

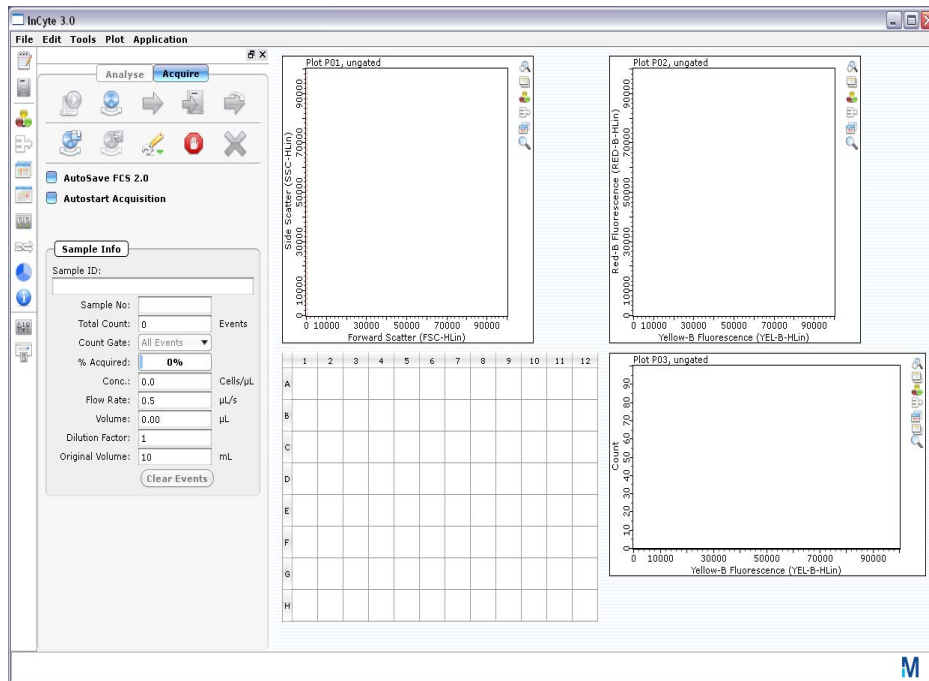

3 Prepare samples for acquisition in tubes.

4 Click the **Start New Data Session File** button.

A dialog box appears allowing you to select a data file name and location, Analysis Method, and instrument and compensation settings.

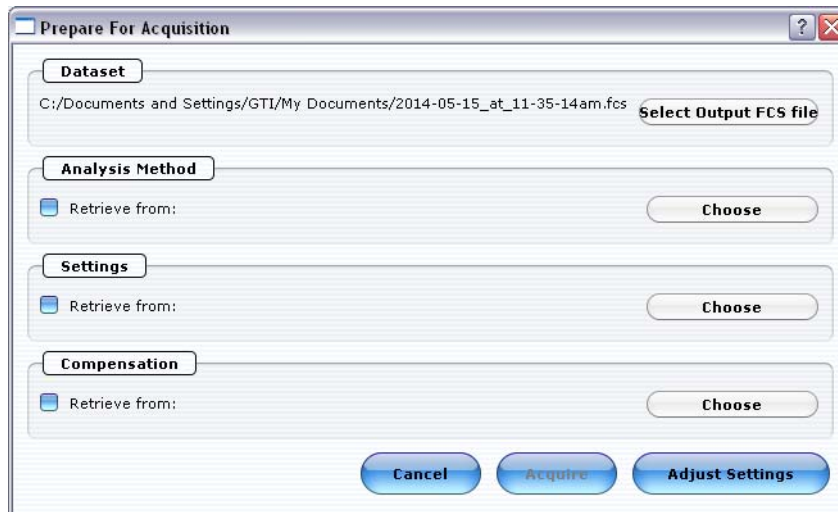

5 An FCS data file will be named and stored automatically. The default storage location is My Documents. The default file name is the date and time. To change the defaults, click **Select Output FCS file**, enter the new information, and click **Save**.

■ **NOTE:** Always save guavaSoft™ software data files directly to the system’s hard drive during acquisition. Saving data to a network or location other than the computer’s

hard drive may result in data loss. You may copy the file(s) to another location when acquisition is complete.

6 Select the information you want to retrieve:

■ **NOTE:** Your system administrator may have configured guavaSoft™ software to disable the retrieval of Methods, instrument settings, and compensation settings from Method files and individual instrument settings files. If the Settings and Compensation retrieval options are disabled, you will not be able to adjust instrument settings. However, you can retrieve settings and Methods from a single FCS file.

- Method – either from an InCyte™ FCS file or a saved Method file (.gsy). Click **Choose**, locate the file, then click **Open**.

The FCS or Method file must be from InCyte™, version 3.0, or later. If you do not choose a Method file, a default one will be created automatically.

If you select an FCS file to obtain the Method, you can also retrieve the instrument settings and compensation settings that were saved with that FCS file.

- instrument settings – either from an InCyte™ FCS file or a saved instrument settings file (.gst). Click **Choose**, located the file, then click **Open**.

The FCS or instrument settings file must be from InCyte™, version 3.0, or later.

- compensation settings – either from an InCyte™ FCS file or a saved instrument settings file (.gst). Click **Choose**, located the file, then click **Open**.

The FCS or instrument settings file must be from InCyte™, version 3.0, or later.

7 Click **Adjust Settings**.

If you retrieved instrument settings and you wish to skip the adjust settings step, click **Acquire** to proceed to acquisition.

A dialog box appears prompting you to load the control sample.

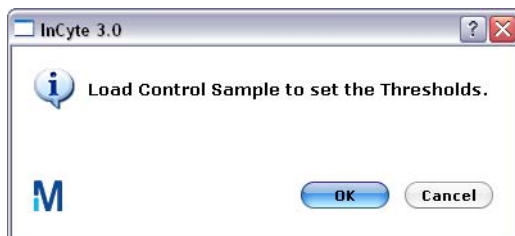

Adjusting Instrument Settings

During adjust settings, if you need to change the sample for a particular step, such as compensation, click the **Next Step** button, then **Adjust Settings**, then load the sample, and click **OK**.

8 Mix a stained cell sample and load it on the easyCyte™ System.

We recommend using a stained negative or isotype control sample for the initial adjustments.

9 Ensure your sample is loaded and click **OK** in the load samples dialog.

10 Check the Conc (Cells/ μ L) value in the Sample Info pane and ensure that it is less than or equal to 500.

- **NOTE:** If the value is greater than the high limit for the corresponding flow rate, dilute the sample with the appropriate buffer to lower the concentration and minimize the risk of coincident events. For optimal performance, we recommend a concentration of 250 cells/ μ L or lower.

11 To fine tune the settings, you can make the following adjustments using the Gain, Compensation, and Miscellaneous Controls. Open each instrument adjustment window using the Tools menu or the icons in the tool bar (left edge of the application window). If necessary, click the window's title bar to drag the window to a new location.

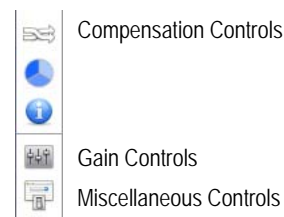

- Use the **Miscellaneous Controls** to set the **Flow Rate** to Very Low (0.12), Low (0.24 μ L/s), Medium (0.59 μ L/s), or High (1.2 μ L/s). The default flow rate is Medium. Set the **Refresh Rate** to the maximum number of events (100–5000) you want to display.
- **NOTE:** If you change the flow rate during the adjust settings step, we recommend that you repeat the adjust settings step at the new flow rate to ensure that the markers and threshold are set correctly.
- If you wish to save area measurements for all parameters, select **Enable Area Mode**. Area will be acquired for all parameters. The threshold parameter, which is always height, will appear in height (H) at the bottom of the plot parameters list. Use the Area/Width menu if you want to acquire width for one parameter.

If you want to acquire area for only one parameter, do not check the Enable Area Mode check box. Instead, select the parameter from the Area/Width menu. The area and width for the selected parameter will be acquired. Use the Area and/or Width Scaling Control sliders to reduce or amplify the signal so that the cells are visible and on scale.

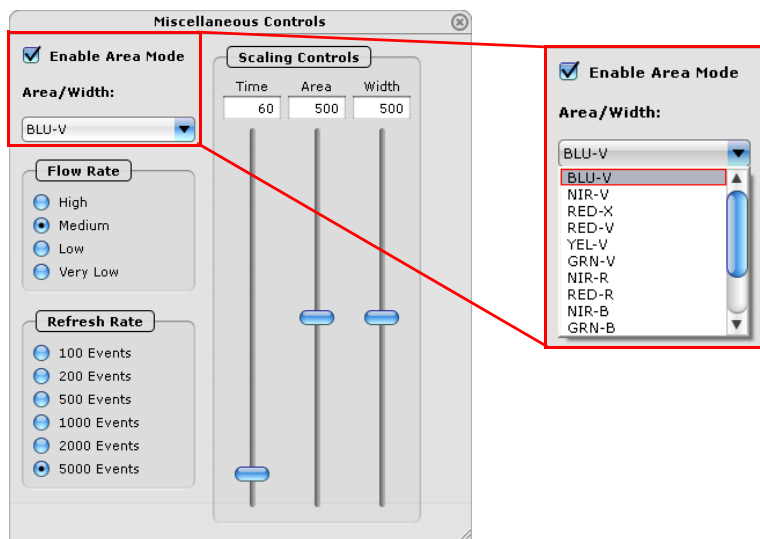

Select **Enable Area Mode** to acquire pulse area for all parameters.

Or, select an individual parameter from the Area/Width menu to acquire area and width for that parameter.

- The time parameter is saved automatically. Use the Time Scaling Control slider to set the maximum time (in seconds) to record. Adjust the y-axis (count) scale on the plot, if necessary.

- Set up the type of plots and parameters you wish to display. If you retrieved a Method, the plots are configured with the regions and gates defined in that Method. Modifications may be necessary to accommodate the new data. For more information on plots and changing the parameters, see page 4-2.
 - Use the **Gain Controls** to select the Threshold parameter from the drop-down menu.
 - Use the **Gain Controls** to adjust the gains (using the sliders or the arrow keys on the keyboard) to a value from 1 to 1024. You can also type a numerical value in any of the Gain text boxes to adjust the settings. Adjust so that the negative population (or isotype) is positioned in the lower-left corner of the fluorescence plot and the cells are evenly distributed in the lower-left quadrant. Start from a lower gain setting and gradually increase the value. For greater detection and sensitivity across a broad range of fluorescence, the overall gain range can be adjusted using the **High** check box. By default, all boxes are checked. If further adjustment is needed or the signal is at its maximum, remove the checks from the High Calibration check boxes and allow the gain to stabilize for 2 to 5 seconds.
- **NOTE:** Use the **Clear Events** button in the Sample Info panel to clear the display.
- To acquire 4 log decades, remove the check from the **5 decade Acquisition** check box.
 - To acquire 4 log decades, remove the check from the **5 decade Acquisition**.
 - If the red and/or violet laser is not needed for your application, you can turn it off by removing the check. For information on the laser and optical filters required to detect the various fluorochromes, see "easyCyte Lasers and Fluorescent Filters" in Specifications.
- **NOTE:** Selecting and deselecting lasers will result in changes in laser power. Additionally, %CVs may vary slightly depending on the laser mode selected for acquisition.
- To adjust the threshold, use the slider or click and drag the threshold marker (dotted red line) up or down the axis of the dot plot displaying the threshold parameter until the desired amount of debris or other unwanted events are eliminated below the threshold. You can also enter a numerical value in the text box and press **Enter** on the keyboard.

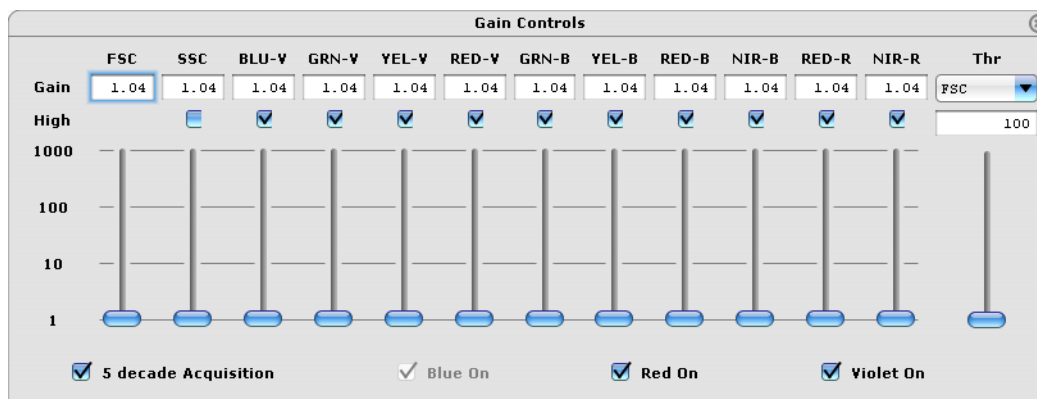

- To adjust compensation, load the appropriate sample, and proceed with the compensation adjustments. You may want to adjust each compensation setting individually using single-stained controls.

Use the **Compensation Controls** to select the radio button for the parameter you wish to subtract, then use the slider to adjust the percentage of the overlapping signal to be removed from the detector.

For more details on specific compensation adjustments and examples, see “Performing Manual Compensation” on page 4-34.

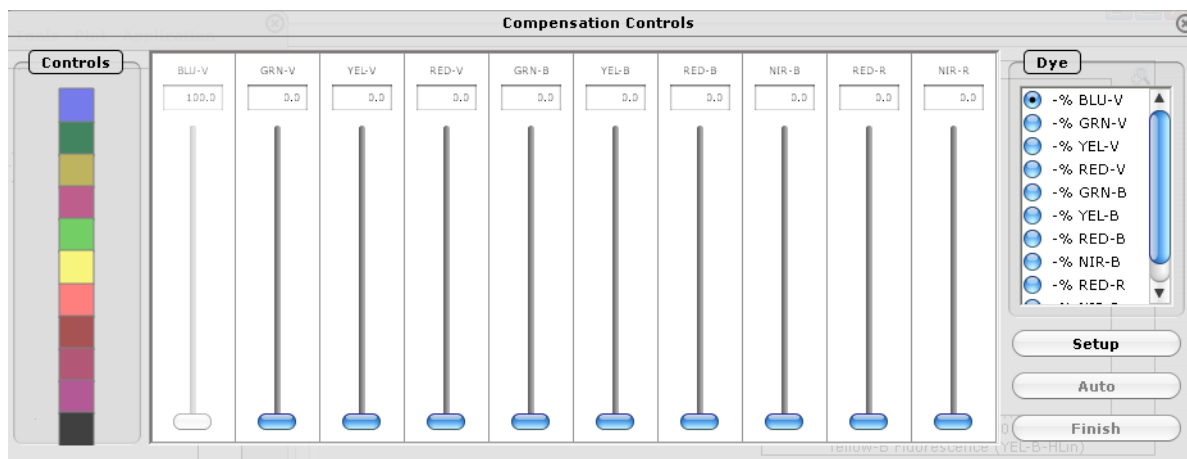

- 12 You may set regions and gates prior to acquiring the samples. See “Regions, Gates, and Statistics” on page 4-19” and “Gates” on page 4-22 for information.

If you wish to apply a count gate, create and define the gate, then select it from Count Gate drop-down menu under Sample Info. You can select the count gate from the Adjust Settings screen only.

You can also view real-time statistics during the adjust settings step. See “Stat Markers” on page 4-26 for information on creating stat markers and viewing the real-time statistics.

- 13 When you are finished adjusting settings, click the **Next Step** button.
If necessary, you can repeat the adjust settings step to ensure that other samples (such as another positive control) are on scale, appropriately positioned, and compensated, by clicking **Adjust Settings**, loading the sample, and clicking **OK**.
If you wish to save the instrument settings, click the **Save Settings** icon in the control panel. Enter a file name and click **Save** to save a .gst file. Once the worklist is complete you can no longer save the instrument settings.

- 14 Vortex the first sample and load it on the instrument.

- 15 Enter the number of events to acquire in the Sample Info panel.
The default number of events to acquire is 5000.

- 16 If you want to identify individual samples or sets of samples, enter an optional ID in the Sample ID field.

The sample ID may be any text up to 40 characters long. If you do not enter a sample ID, the default sample number will be used as the sample ID, for example, Sample #1, Sample #2, etc.

- NOTE: If you click **Autostart Acquisition** and wish to enter a sample ID, type the ID into the Sample ID field after acquisition is complete and before loading the next sample.

- 17 Click the **Acquire Next Sample** button.

The system acquires the first sample.

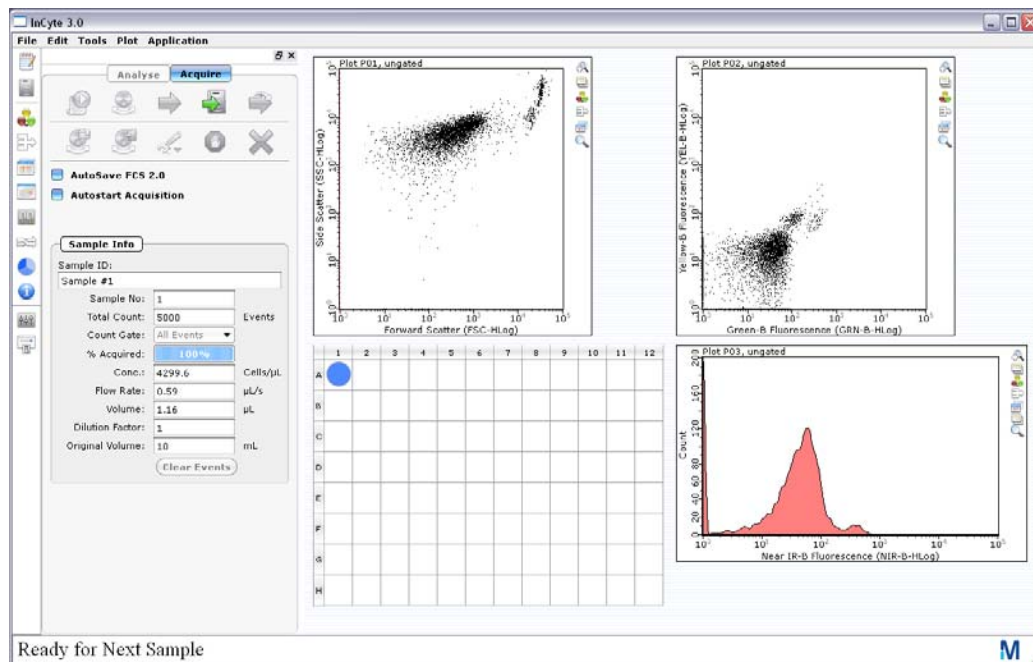

ACQUISITION NOTES

- If you select **Autostart Acquisition**, acquisition automatically starts when you load each tube. You do not need to click **Acquire Next Sample**. Autostart Acquisition automatically turns off if you click any of the following: **Adjust Settings**, **Retrieve Settings**, **Quick Clean**, or **Backflush**. You must recheck the box to continue using the feature.
- If the acquisition rate appears to slow dramatically, the fluid pathway may be blocked. Click the **Abort** button, then click **Capillary Cleaning Tools** and select **Backflush**. Load a tube of 20% bleach and click **OK**. When the backflush is complete, select **Quick Clean**. Load a tube of DI water and click **OK**. Click **Acquire Next Sample** to continue.

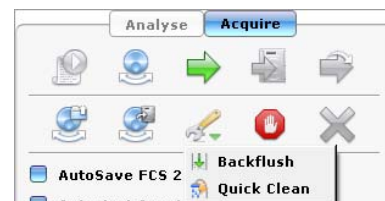

- The progress bar provides an estimate of the target event count during the acquisition period, which times out after 1.75 minutes (high flow rate), 3.5 minutes (medium flow rate), 7 minutes (low flow rate), or 10 minutes (very low flow rate).
- **NOTE:** If a clog or loss of signal is detected, we recommend removing the clog by running a Quick Clean with water, then a Quick Clean with ICF, followed by Backflush into an empty tube, then another Quick Clean with ICF, and a final Quick Clean with water.

18 Click Save and Close Current Sample.

You may still enter or change the Sample ID for the current sample before clicking Save and Close Current Sample.

19 Repeat steps 14 through 18 for the remaining samples.

20 Click the Stop and Close Session File after the last sample.

21 When you are finished, click Capillary Cleaning Tools and select Quick Clean. Load a tube of deionized water and click **OK**. If you ran blood samples, run two Quick Clean cycles with water, followed by one cycle using ICF, and finally one cycle using water to rinse.

At the completion of the run, a copy of the Data, Method, and AnalysedGroup are automatically loaded into the Analysis control panel. guava InCyte™ saves the data for all samples as a single FCS 3.0 file to the specified location.

The FCS file contains:

- the acquired data for all tubes in the run
- the Method (plots, regions, gates, and metrics, if applicable)
- an AnalysedGroup (the data paired with the Method)
- instrument settings (gains, compensation, miscellaneous settings)

guava InCyte™ Analysis

InCyte™ Software allows you to open and analyze any guava® FCS 3.0 data file, regardless of the software module used for acquisition. An analysis-only version of InCyte™ 3.0 is available for MacOS 10.6 and later. See the readme file for more information and details on where to go to download the software.

You can proceed to analysis from the acquisition screen.

The Analysis Panes

Click the **Analyse** button at the top of the control panel to access the Analyse control panel. If you click Analyse from the Acquisition screen after acquiring a sample, the data from the last sample acquired is displayed.

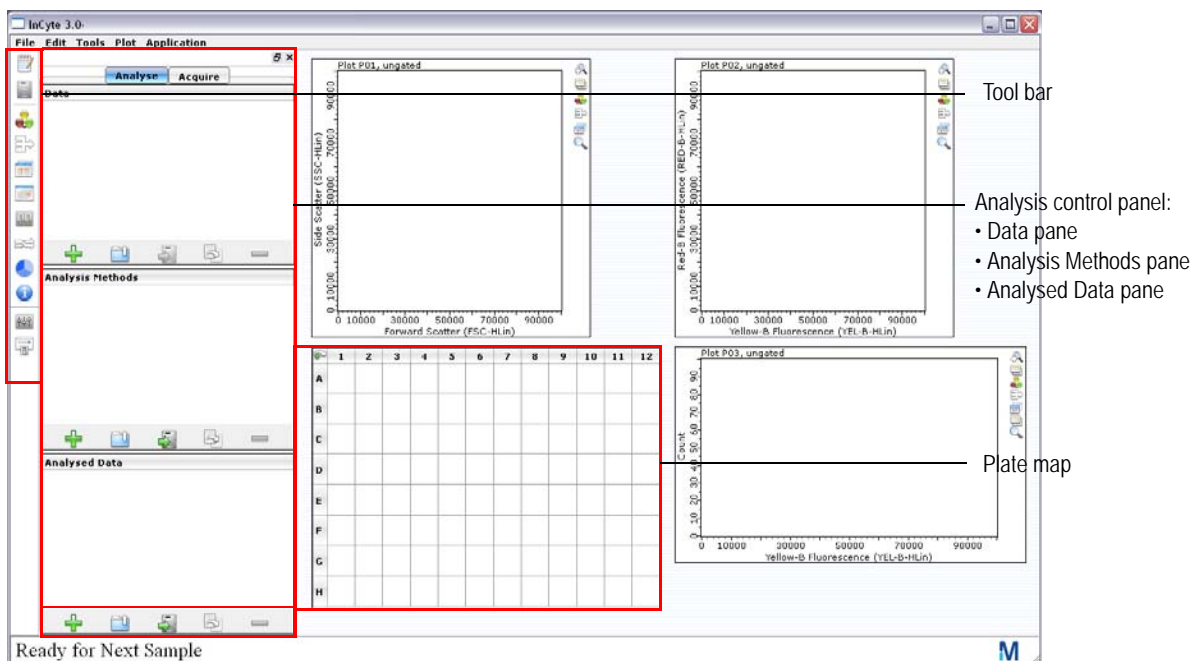



Figure 4-2 InCyte™ application window – Analysis screen

The Analyse control panel provides a working outline for each analysis session. It contains three panes—the Data, Analysis Methods, and Analysed Data. An FCS file generated using InCyte™ will automatically contain all three elements.

- The **Data** pane lists all open FCS files, as well as any groups (FCS file subsets) created. For more information on groups, see “Creating a Group” on page 4-46.
- The **Analysis Methods** pane contains all Method(s), each comprised of its associated plots, regions, gates, and metrics. Methods can be thought of as analysis strategies.
- The **Analysed Data** pane lists all user-defined AnalysedGroups. Analysed Groups are created by pairing the data file with Method—each consisting of a data file (or group) with its associated Method. When you close an Analysed Group, the associated FCS file and Method will close automatically.

Place your cursor over an icon in any of the three panes to see text describing the icon . For more information on the control analysis panels, see “Analyse Control Panel” on page 1-19.

Analyzing Files Acquired Using InCyte™

Data files acquired using InCyte™ will already have the necessary components for each of the three Analysis panes—the data file, the Method, and the Analysed Group. Simply open the FCS file.

During analysis, the original FCS file and any analysis settings (plots, parameters, gates) will not be affected. If you wish to save any changes to the newly analyzed InCyte™ file, simply resave the file using the Analysed Data pane (Save Analysed Group button).

You can proceed to analysis from the acquisition screen.

- **NOTE:** You can analyze tube-based data but the results cannot be displayed in the plate map. Additionally, the gates and markers do not carry over from one tube to the next. Tubes must be analyzed individually (tube-by-tube basis). Use the Stat Setup feature to obtain results for tube data.
 - **NOTE:** If you open and analyze multiple files within a session, all the FCS data files, Methods, and Analysed Groups will remain in the panes from all file that were opened. If they have already been saved, you can remove them from the pane by selecting the item and clicking the **Delete** icon at the bottom of that pane.
- 1 From the Analyse screen, choose **File > Open** from the menu bar. Select an FCS file for analysis and click **Open**. You can also use the **Open Group** icon in the Data pane or the **Open Analysed Group** icon in the Analysed Data pane. You can also drag and drop an FCS file from a folder to the Data pane.

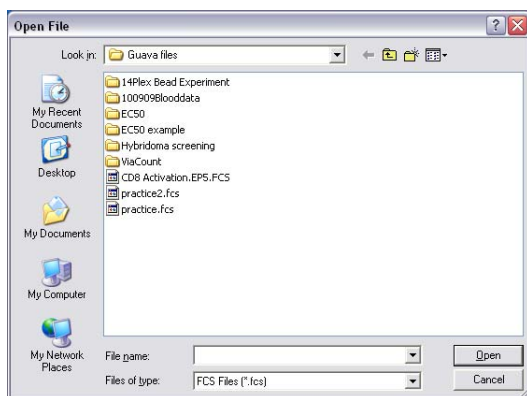

The data for the first sample appears. For information on selecting the number and type of plots (dot plot, histogram, or contour plot) you wish to display, and changing the plot parameters, see “Plots” on page 4-2.

Click the + to the left of the data file name to display a list of all samples contained in the file. All wells with acquired data appear as open circles in the corresponding locations in the plate map.

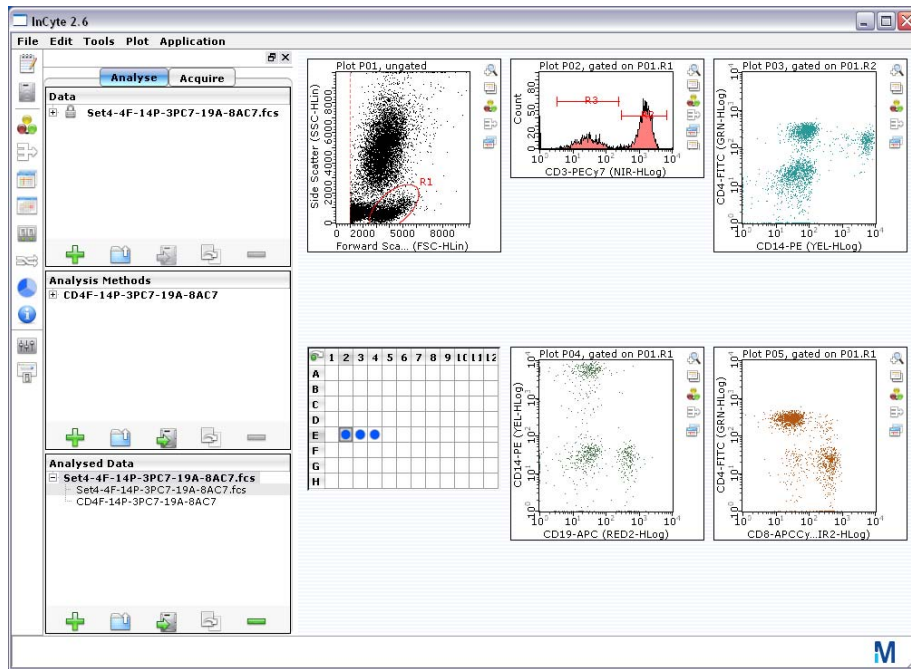

Clicking on a sample in the Data pane will display the unanalyzed data for that sample in the plots, however the information in the plate map will be lost. Click on the Analysed Group to redisplay the information in the plate map. If the data is already analyzed, click on the individual wells in the plate map to display the analyzed data for that well in the plots, or use the arrow keys to quickly scroll through the wells, displaying the data.

NOTE: An icon appears in the upper-left corner of the plate map. It allows you to toggle between the tube map and plate map. Samples from tubes acquired on your easyCyte™ System will always appear in the plate map. If the data set was acquired on an easyCyte™ HT System, which allows you to acquire from both tubes and a microplate, the samples acquired from tubes will show up in the tube map.

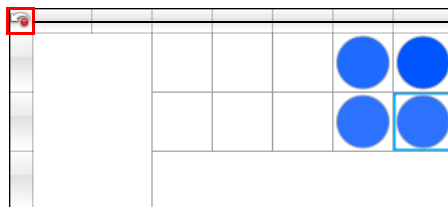

If applicable, click icon to toggle between plate map and tube map.

- **NOTE:** If you wish to create groups of samples for analysis, see “Creating a Group” on page 4-46.
- 2 You are now ready to start customizing your Analysis Method using regions and gates. See “Regions, Gates, and Statistics” on page 4-19.

Analyzing Files Acquire Using Other guava[®] Software Modules

Data acquired using any guavaSoft™ module other than InCyte™, for example, ExpressPro, will not have an Analysis Method associated with it. However, when you open the file in InCyte™, a default Method will automatically be created.

- 1 From the analysis pane, choose **File > Open** from the menu bar. Select an FCS file for analysis and click **Open**. You can also use the **Open Group** icon in the Data pane or the **Open Analysed Group** icon in the Analysed Data pane. You can also drag and drop an FCS file from a folder to the Data pane.

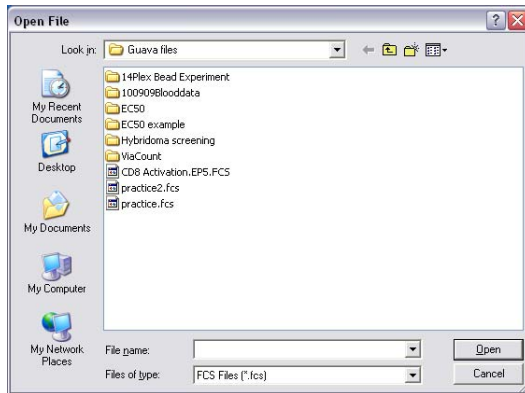

The data for the first sample well appears. For information on selecting the number and type of plots (dot plot, histogram, or contour plot) you wish to display, and changing the plot parameters, see “Plots” on page 4-2.

Click the + to the left of the data file name to display a list of all sample wells and tubes contained in the file. All wells with acquired data appear as open circles in the corresponding locations in the plate map. Data for any well can be displayed in the plots by selecting the sample from the file list or clicking on a well in the plate map.

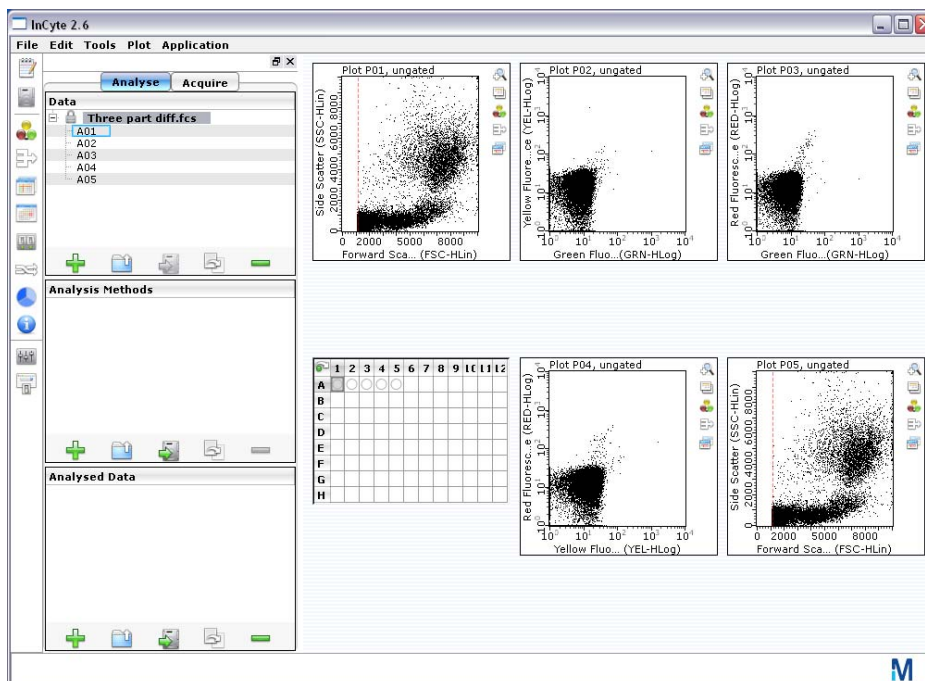

- When a data file is generated in a *guava*[®] software module other than InCyte[™], InCyte[™] will automatically create a default Analysis Method and Analysed Group for the data file/set. The Method will contain a percent (%) metric, initially. If you wish to open an existing Method use the **Open Method** icon. Method files have the extension .gsy. To rename the Method, double-click it and enter a new name related to this analysis.

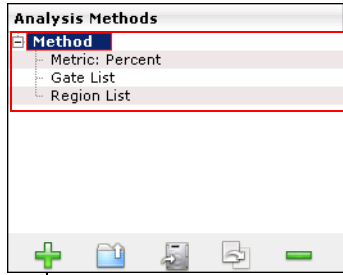

Analysis Method containing a metric, gate list, and region list.

Click New Method to create a new Method.

- If you opened an existing Method, you will need to drag it to the Analysed Group.

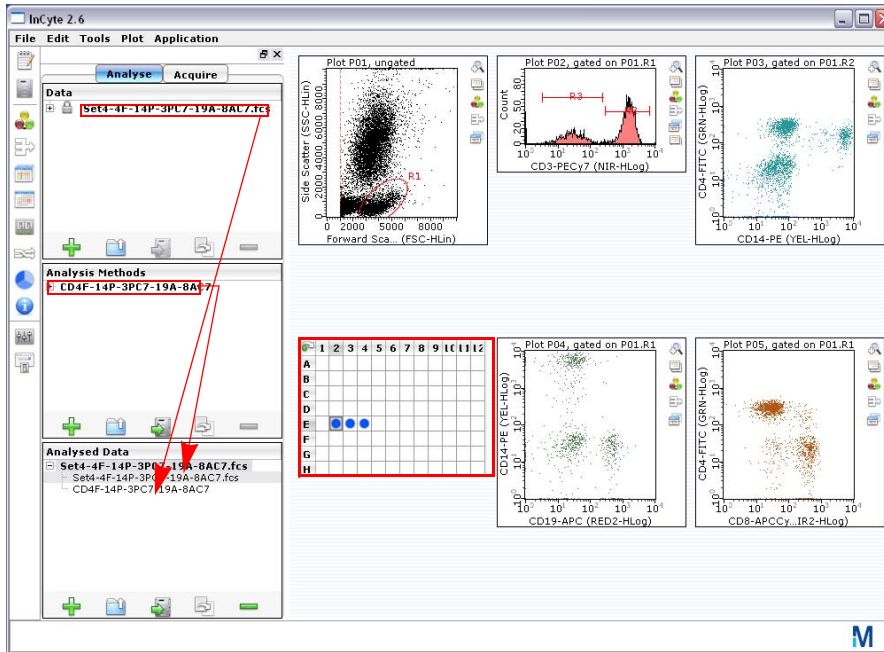

Data and Method are automatically paired to create an Analysed Group. If you open a saved Method, you will need to drag it to the Analysed Group.

Notice the sample wells in the plate map become dark blue (if the Method was newly created) or various shades of blue (if a previously defined Method is used). You can place the cursor over any well in the plate map to view results for that sample. Clicking on a sample in the Data pane will display the unanalyzed data for that sample in the plots, however the information in the plate map will be lost. Click on the Analysed Group to redisplay the information in the plate map. Click on the individual

wells in the plate map to display the analyzed data for that well in the plots, or use the arrow keys to quickly scroll through the wells, displaying the data.

- **NOTE:** Any data file or Method file can be replaced by simply selecting it from the respective pane and dragging to the Analyzed Group. This allows you to quickly interchange data files and Methods.

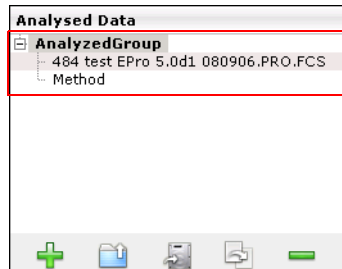

AnalysedGroup containing a data file and Analysis Method.

To save an AnalysedGroup, click on it in the Analysed Data pane to select it, then click the Save Analysed Group icon. Navigate to the location, enter a name, and click **Save**. The AnalysedGroup will be saved as an FCS file and will contain the method (regions, gates, metrics, and stats), as well as the data and the instrument settings.

- 4 You are now ready to start customizing your Analysis Method using regions and gates. Refer to “Regions, Gates, and Statistics” on page 4-19.

Regions, Gates, and Statistics

Regions

InCyte™ offers six types of regions/markers—ellipses, rectangles, octagons, polygons, and quadrant markers for dot plots, and histogram markers for histograms. All of these regions are created using either the New Region icon in the plot tool bar (see “Plots” on page 4-2), except the quadrant marker, or the New Stat Marker icon in the tool bar, which allows you to select statistics for the region/marker. For information on creating quadrants, refer to “Stat Markers” on page 4-26. A single Analysis Method can contain a maximum of 24 regions or stat markers, and you can have multiple stats per marker.

InCyte™ regions are associated with the one (histogram) or two (dot plot) parameters in which they were created. If you change the x- or y-axis parameter on the plot, the region is no longer displayed. However, it is still contained within the Method.

- 1 Once an AnalysedGroup is created, either by pairing a data file with a Method or dragging the AnalysedGroup to the legend, click the **New region** icon in the plot tool bar and select a region from the pop-up menu.

You are prompted to enter a region name. The default is R1. When creating a polygon, this dialog appears after you create the region.



2 Enter a name for the region and click **OK**.

You may leave it R1, but a unique region name can be helpful in differentiating Analysis Methods.

The newly created region appears on the plot with the region name. Click and drag the name to move it. The region is listed in the Region List under the Method (see below) and in the Region List table (Region List icon in the main tool bar or Tools > Show Region List). To delete a region, see “Region List” on page 4-21.

3 Adjust the region to encompass the data. Or, for a polygon, create the region.

- To adjust an **elliptic region**, click anywhere on the edge of the ellipse, except on a handle, and drag it to a new location. The ellipse has two handles. The open circle allows you to narrow/widen the ellipse. The solid circle allows you to lengthen, as well as rotate the ellipse around a point opposite the solid circle.

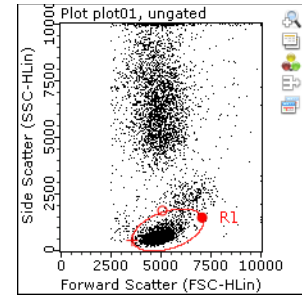

- To adjust a **rectangle region**, click anywhere on the edge of the rectangle, except on a handle, and drag it to a new location. The rectangle has five handles. The open squares allow you to extend at the corresponding corner. The solid square allows you to rotate and resize.

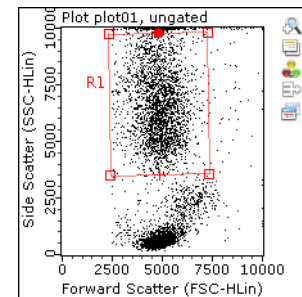

- To adjust an **octagonal region**, click anywhere on the edge of the octagon, except on a handle, and drag it to a new location. The octagon has eight handles. Click and drag the handles to adjust the shape of the octagon. To add or remove segments, right-click on a handle and select **Insert Line Segment** or **Delete Line Segment**.

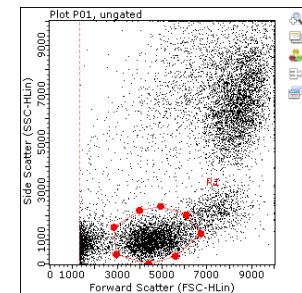

- To create a **polygon region**, click to add the first handle, then move the cursor to the next point and click. Continue creating up to 32 segments until the shape is complete. Finish by clicking again at the first handle to close it. To move it, click anywhere on the edge, except on a handle, and drag it to a new location. To adjust the shape, click and drag the handles. To resize or rotate, press the Shift key and click and drag a handle.

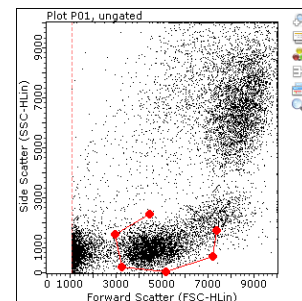

- To adjust a **histogram region**, click either of the two handles. The histogram marker can be moved vertically as well as horizontally.

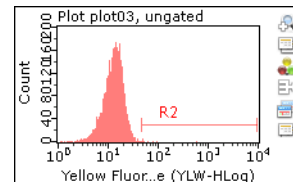

Region List

When you create a region, it appears in the Region List. To display the list, click the Region List icon in the tool bar or choose **Tools > Show Region List**. The Region List displays a list of all regions and quad stat markers (see page 4-26) in the selected Analysis Method, their type, and plots axes.



- To display all the columns in the Region List window, click **Resize**.
- To delete a region from the plot, click to select it, then right-click and select **Delete Region**. You can also select the region in the Region List window and click **Delete**. Click **OK** in the confirmation box. The region will be deleted from all associated plots. The region name in the Analysis Method will appear as ???.

Global and Local Region Adjustments

You can make adjustments to regions for specific samples within a data set. For example, you may wish to tweak a region for the data in one or more samples to compensate for a shift in the data.

- To change a region for an individual sample, **press and hold the Ctrl key** while manipulating the region (elliptic, rectangle, octagon, or histogram). To change the region for multiple samples, highlight the desired wells, then hold the Ctrl key while manipulating the region. The change will be applied to all the highlighted samples.

The region will turn from red to black, indicating that it is a local region—it applies only to the sample data displayed in the plots.

- NOTE:** If you manipulate a global region without holding down the Ctrl key, the change will automatically apply globally (to the data for all samples in the run).

Once a local region is created:

- if you have only one local region in the data set and you attempt to manipulate it without holding down the Ctrl key, the change will become global and apply to all regions in the data set.

- if you have multiple local regions and you attempt to manipulate a single local or global region without holding down the Ctrl key, the following message appears:

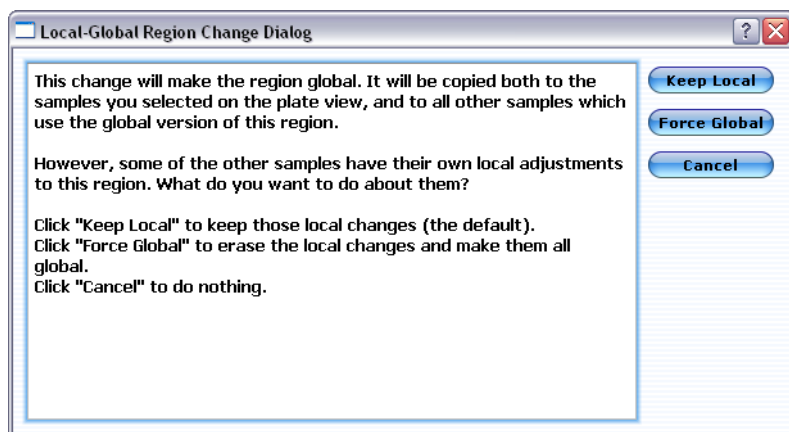

- To apply the change to the region you are adjusting and all global regions, but keep any other local regions unchanged, click **Keep Local**.
- To apply the change to all samples in the run, click **Make Global**.
- To cancel the change and not apply it to any regions, click **Cancel**.

If you want to make an adjustment to a local region to manipulate it further, hold down the Ctrl key to keep the change local and not affect any other regions—local or global.

After making a region(s) local, you can still make adjustments to global regions without holding down the Ctrl key. When the dialog box appears, click **Keep Local**. The adjustment will apply to all global regions. The local regions will remain local and unchanged.

Gates

A gate can be as simple as a single region, or a complex combination of regions and multiple parameters. Gates allow you to further characterize and isolate populations based on the regions. A maximum of 32 gates can be created for one Analysis Method.

You can create gates for analysis and/or acquisition. Count gates used during acquisition allow you to acquire specific populations of interest. All events above the threshold are saved to the file whether they are in the gate or not. However, the number of Events to Acquire is applied to events that fall within the gate.

Defining a Gate

The gating process has been simplified by dragging and dropping regions. Any region can be dragged from one plot to any other plot. This process allows you to create gates defined with the “AND” operator. You can also create gates using the OR and NOT operators. Refer to “Gate List” on page 4-24.

- 1 Click to select the region (handles appear), then click in the center of a region and drag it to another plot.
This “applies” the data within the boundaries of the region to the second plot. For example, if you created a region on live cells in plot 1 and drag the live-cell region to plot 2, only the live cells will be displayed in plot 2. A New Gate Name dialog box

prompts you to rename the newly created gate. You can enter a more meaningful name or use the default.

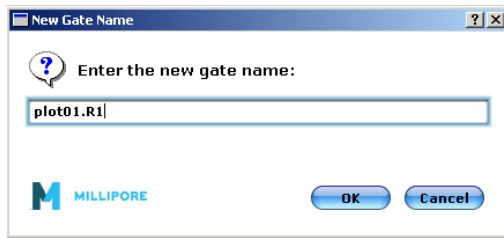

- **NOTE:** You can also define a gate by typing the regions and the operators AND, OR, and NOT. Refer to “Gate List” on page 4-24.

If the Analysis Method has gates already defined, you can also select a gate from the *Plot gate* menu in the plot tool bar.

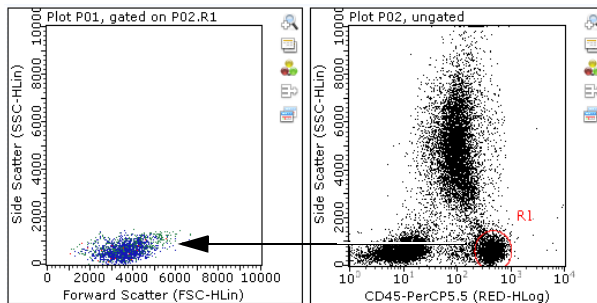

Select the region, then drag it from one plot to another to apply a gate.

When you apply a gate, the following changes occur:

- The events displayed in Plot 2 will automatically change to reflect only those defined by the region that was dragged in. To view the ungated data again, click the **Plot gate** icon to the right of the plot and select *<ungated>*.
 - The color of the newly gated data will reflect the color of the gate defined in the Gate List window. The default color for the first gate is red.
 - The plot heading will reflect the gate applied (for example, *Plot P01, gated on P02.R1*).
 - The newly created gate will appear in the Analysis Methods pane under the Method, in the Gate List (see "Gate List" below), and the Plot gate pop-up menu to the right of the plot.
- **NOTE:** Changes made to the position or size of any region(s) used to define a gate will automatically be reflected in all plots gated by that region.

Gate List

When you create a gate, it appears in the Gate List. To display the list, click the Gate List icon in the tool bar or choose **Tools > Show Gate List**. The Gate List displays a list of all gates in the selected Analysis Method, their definition, and color.

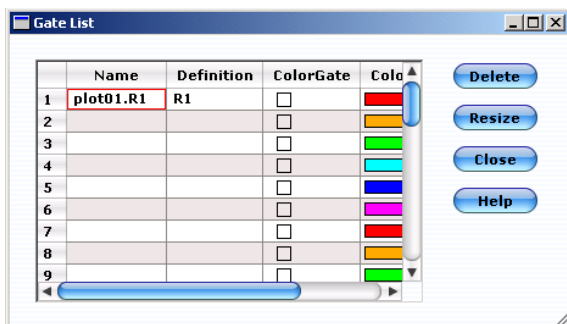

- To display all the columns in the window, click **Resize**.
- To delete a gate from the list, select the gate and click **Delete**. Click **OK** in the confirmation box.
- To change the gate color, double-click the color in the Color column. The ColorPickerDialog appears. See “Changing the Color of Gated Data” on page 4-25 for information on using this dialog box to change the color.
- You can turn a region into a gate by entering a name for the gate in the Name field and typing the region name (for example, R1) in the Definition field.
- You can also define a gate using the operators AND, OR, and NOT. Create regions to identify the subpopulations of interest. Open the gate list and type an appropriate name for the gate. Type a definition, for example:
 - R1 AND R2 means the event must be in *both* the R1 and R2 regions to be included in the gate.
 - R1 OR R2 means the event must be in *either* the R1 or R2 region to be included in the gate.
 - R1 AND (NOT R2) can be used if R1 and R2 overlap and you want to include events in R1 but not in R2.

The gate can now be applied to any plot by clicking the **Plot gate** icon to the plot tool bar and selecting the gate from the list.



- The ColorGate box allows you to view a backgate. Create a gate in one plot, then drag that gate to the plot of interest. This applies the gate to the second plot and shows only the gated events. Select Tools > Show Gate List and check the ColorGate box for the gate. The gated events appear in both plots in the selected

color. View the second plot without a gate (select <ungated> from the plot tool bar) to see the color gated events in relationship to all events.

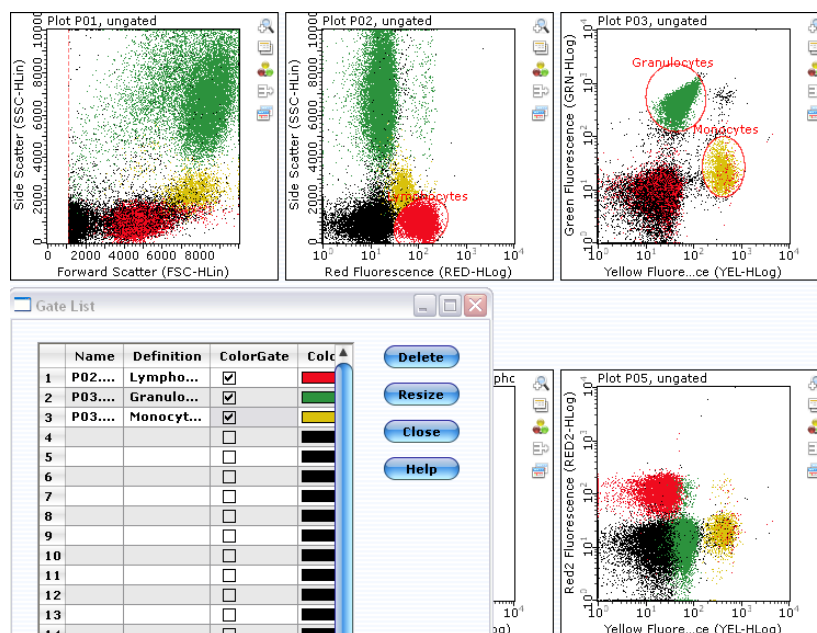

A lymphocyte gate was created in the RED (CD3 PE-Cy5.5) vs SSC plot, then dragged to the YEL (CD14 PE) vs GRN (CD15 FITC) plot. Granulocyte and monocyte gates were created in the YEL vs GRN plot and dragged to the RED vs SSC plot. ColorGate checkboxes were selected for all gates to apply color to the gated events. All plots are viewed ungated to show all data and gated data in colors.

Changing the Color of Gated Data

You can change the color of data within a gate. Open the Gate List and double-click the color in the Color column to open the ColorPickerDialog. Use this dialog to change the color, hue, saturation, and brightness.

- 1 To change the color, click the RGB button and use the sliders to adjust each color. Or, click to select a color in the outer circle. Drag the pointer to change the color.
- 2 To adjust the hue, saturation, or brightness, click the HSB button and use the sliders to make the appropriate adjustments. Or, click a shade in the inner triangle.
- 3 Click **OK** when you are finished.

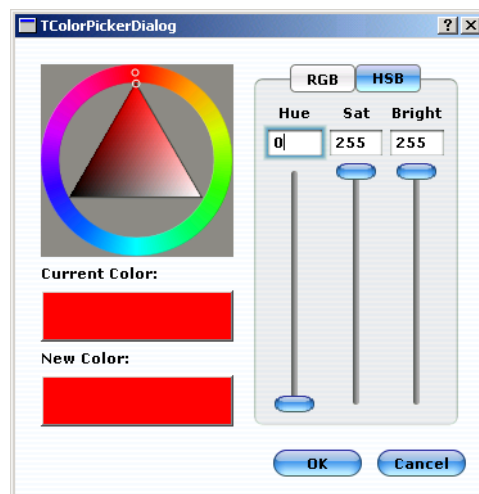

Stat Markers

The Stats feature allows you to derive, display, and export statistics for single samples, groups, or whole data sets. Each stat is derived from a region/marker. Stats can be assigned to existing regions, or new regions can be created. A single Analysis Method can contain a maximum of 24 regions/markers.

- 1 Click the **New Stat Marker** icon in the plot tool bar and select the appropriate option. You can obtain statistics for any existing regions in the plot. Or, you can create a new region and obtain statistics for that region.
 - Select **New Elliptic/Rectangle/Octagonal/Quad/Histogram Stat Marker** to add a new region and obtain stats for it. Histogram Stats appear only in a histogram plot.
 - Select **New Stat for R1** (or name of existing region) to obtain stats for an existing region.
 - Select **New Expression Stat** to create an expression statistic. See "Creating Expression Statistics" on page 4-29.
 - Select **Show Stat Setup** to display the Current Run Stats. See "Current Run Stats Window" in the following section.
 - Select **Edit Plot Corner Labels** to add custom labels to your plots. See "Labeling Plot Corners" on page 4-31.

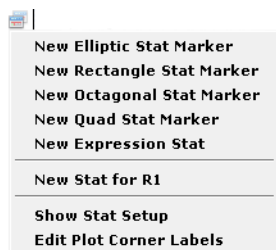

The Add New Stat Marker window appears for the stat type you selected. The default base stat name is the same as the gate name. Base stat implies it is the base name

before you selected a specific metric (stat), then the stat name becomes *BaseStatName.Metric*.

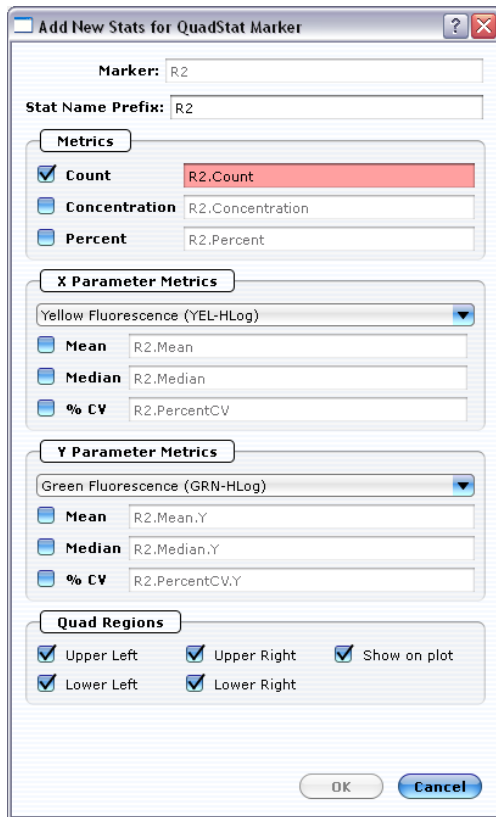

If a stat with the default name already exists, the field will appear red. You must enter a new stat name.

- 2 Select the metric—**Percent**, **Count**, **Mean**, and **Median**, **Concentration**, or **%CV**.
- 3 For quad stats only, select the quad region(s) of interest. Select **Show on plot** if you wish to see the stat for each quadrant appear in the corners of the plot. If multiple parameters are selected, the count appears by default. Quadrant markers will appear on the plot after you click **OK**.
- 4 Click **OK**.

The Current Run Stats window (see below) appears with the newly created stat. The value listed corresponds to the sample well highlighted in the plate map. Each stat is automatically applied to all samples in a given data set. To see the results for any well, click on the well in the plate map. If you adjust the marker/region or any region that is part of the gating strategy, the statistics are automatically updated.

To adjust quadrant markers, click to select the markers. The handles will appear solid. Position the cursor over the handle at the intersection and drag to the desired location. You can adjust the angle of the markers $\pm 44^\circ$ from their original locations. Drag the handle (solid circle) towards the end of the marker and tilt it to the desired location.

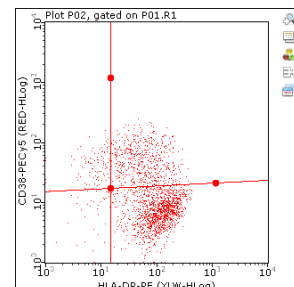

Current Run Stats Window

The Current Run Stats window appears when you create a stat. You can also click the **Show Current Run Stats** icon in the main tool bar or select **Tools > Show Current Run Stats** from the menu bar to display the window. For each Analysis Method, all stats for all plots are listed in this window. The Values displayed correspond to the sample well highlighted in the plate map. Simply click any well to see the value for that sample. Stats are listed in the order they were created. To reorder them in the list, see “Current Run Stats Setup Window” on page 4-28.

For each Analysis Method, all stat markers are listed in the Region List, as well as the Analysis Methods pane. All stats are saved with the Method.

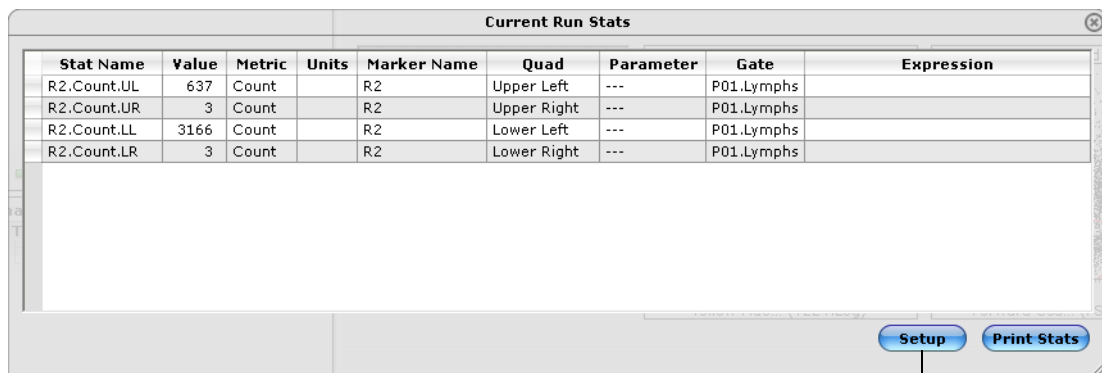

Stat Name	Value	Metric	Units	Marker Name	Quad	Parameter	Gate	Expression
R2.Count.UL	637	Count		R2	Upper Left	---	P01.Lymphs	
R2.Count.UR	3	Count		R2	Upper Right	---	P01.Lymphs	
R2.Count.LL	3166	Count		R2	Lower Left	---	P01.Lymphs	
R2.Count.LR	3	Count		R2	Lower Right	---	P01.Lymphs	

customize stats

- Click Setup to customize the stats listed in the Current Run Stats window.
- Click **Print Stats** to print the statistics listed in the table.
- To copy the window to the clipboard right-click in the window and select **Copy to Clipboard**.

Current Run Stats Setup Window

To customize the statistics that are listed in the Current Run Stats window, click **Setup**. The Current Run Stats Setup window appears.

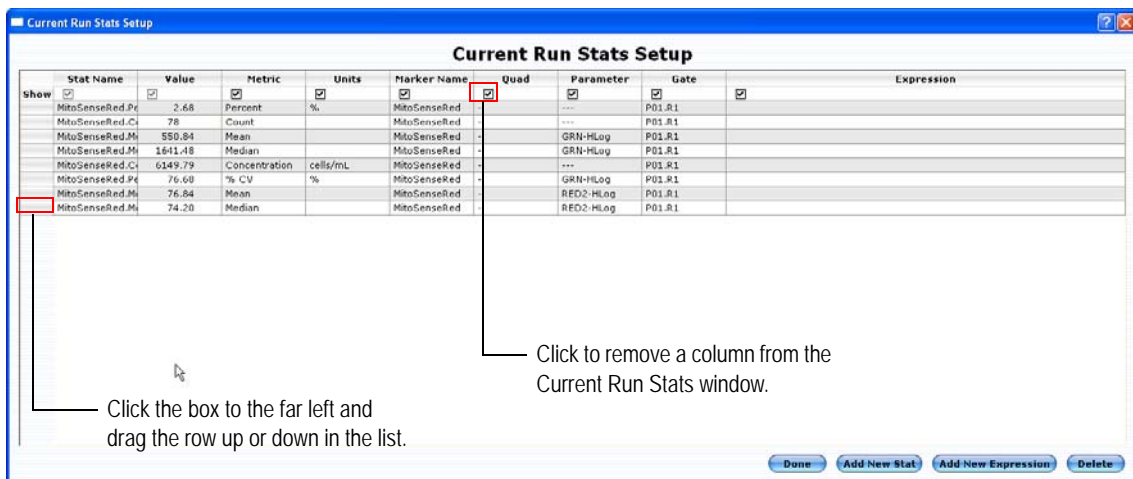

Stat Name	Value	Metric	Units	Marker Name	Quad	Parameter	Gate	Expression
<input type="checkbox"/> show	<input type="checkbox"/>	<input type="checkbox"/>	<input type="checkbox"/>	<input type="checkbox"/>	<input type="checkbox"/>	<input type="checkbox"/>	<input type="checkbox"/>	<input type="checkbox"/>
MitoSenseRed.Pr	2.68	Percent	%	MitoSenseRed		---	P01.R1	
MitoSenseRed.C1	78	Count		MitoSenseRed		---	P01.R1	
MitoSenseRed.M1	559.84	Mean		MitoSenseRed		GRN-HLog	P01.R1	
MitoSenseRed.M2	1641.48	Median		MitoSenseRed		GRN-HLog	P01.R1	
MitoSenseRed.C2	6149.79	Concentration	cells/mL	MitoSenseRed		---	P01.R1	
MitoSenseRed.F4	76.69	% CV	%	MitoSenseRed		GRN-HLog	P01.R1	
MitoSenseRed.M3	76.84	Mean		MitoSenseRed		RED2-HLog	P01.R1	
MitoSenseRed.M4	74.20	Median		MitoSenseRed		RED2-HLog	P01.R1	

Click the box to the far left and drag the row up or down in the list.

Click to remove a column from the Current Run Stats window.

- To change the Stat Name, double-click the name and enter a new name. To change the metric, gate, quadrant, marker name, or parameter, double-click the item and select the new one from the drop-down list. Expression stats cannot be modified. They can only be deleted.
 - **NOTE:** If you wish to change the parameter, double-click to display the parameters for that plot. If you wish to see all available parameters for the data set, press Ctrl and double-click the parameter value. For a parameter to be displayed, you must select it in the Add New Stat Marker dialog.
- To remove a column, remove the “Show” check mark for the selected parameter(s) and click **Done**. The Current Run Stats window is updated.
- You can also create stats directly from the Current Run Stats Setup window. Click **Add New Stat** to display the Add New Stat Marker window. This window is similar to the window that appears when you select **Show Stat Setup** from the New Stat Marker icon in the plot tool bar (see page 4-26). However, this stat marker window allows you to create a stat independent of a plot and based on any gate. Enter a stat name, then select the marker/region, gate, parameter, and metric, and click **OK**.
- To reorder the rows and/or columns in the Current Run Stats Setup window, click the far-left box of the row and drag the row up or down, or click the column header and drag the column to the left or right. You cannot move the Stat Name or Value column. They are fixed.
- To delete a stat, select the stat from the list and click **Delete**.

Creating Expression Statistics

Expression stats allow you to create custom statistics. For example, you can apply the dilution factor to a count or concentration value of a specific population to get the actual value for your diluted sample. Or, you can create an expression statistic that adds the events in two quadrants of quad markers.

- 1 Create statistics as you normally would.
- 2 Click the **New Stat Marker** icon in the plot tool bar and select **New Expression Stat**.

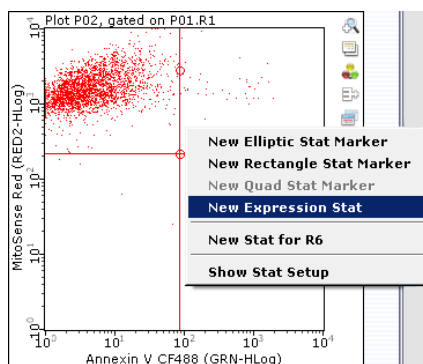

- 3 Enter a stat name for the expression.

- Right-click in the Expression area of the window and select the stat. Type an operator (+, -, *, /, or ^ for exponentiation). Complete the expression.

■ **NOTE:** To create an expression for a specific tube, press Ctrl and right-click the Expression area. The pop-up menu allows you to select a specific tube.

The following example shows an expression created to apply the dilution factor of 20 to events in the upper-left quadrant of a plot.

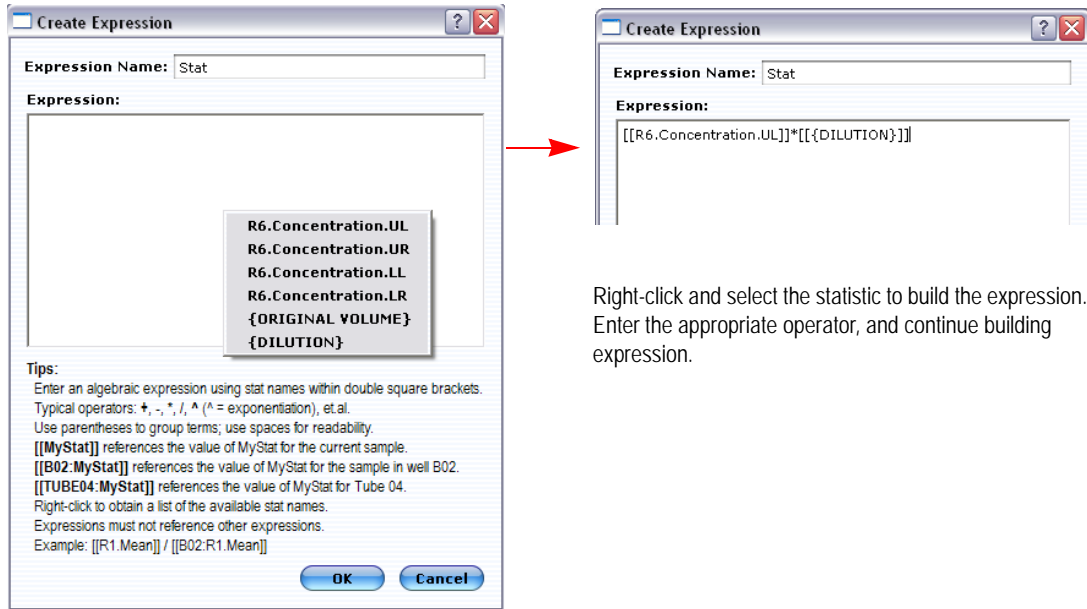

Right-click and select the statistic to build the expression. Enter the appropriate operator, and continue building expression.

- Click **OK**.

The expression appears in the Current Run Stats window.

The image shows a screenshot of the 'Current Run Stats' window. It contains a table with the following data:

Stat Name	Value	Metric	Units	Marker Name	Quad	Parameter	Gate	Expression
R6.Concentration.UL	8.52E+04	Concentration	cells/mL	R6	Upper Left	---	P01.R1	
R6.Concentration.UR	1193.91	Concentration	cells/mL	R6	Upper Right	---	P01.R1	
R6.Concentration.LL	122.45	Concentration	cells/mL	R6	Lower Left	---	P01.R1	
R6.Concentration.LR	3091.91	Concentration	cells/mL	R6	Lower Right	---	P01.R1	
Stat	8.52E+04	Custom Expression						[[R6.Concentration.UL]]*[[{DILUTION}]]

At the bottom of the window are 'Setup' and 'Print Stats' buttons.

- Click the Show Sample Info icon in the tool bar to the left of the data panes to open the sample information window. Enter the dilution factor for the sample and press Enter.

The image shows a screenshot of the 'Sample Info' dialog box. It contains the following fields and values:

- Sample ID: A01
- Sample No: 1
- Dilution Factor: 20
- Original Volume: 10
- Quantity: 0
- Threshold Parameter: FSC-HLin
- Threshold Value: 151
- Count Gate: All Events

- The updated concentration value, based on the new dilution factor, appears in the Current Run Stats window.

Stat Name	Value	Metric	Units	Marker Name	Quad	Parameter	Gate	Expression
R6.Concentration.UL	8.52E+04	Concentration	cells/mL	R6	Upper Left	---	P01.R1	
R6.Concentration.UR	1193.91	Concentration	cells/mL	R6	Upper Right	---	P01.R1	
R6.Concentration.LL	122.45	Concentration	cells/mL	R6	Lower Left	---	P01.R1	
R6.Concentration.LR	3091.91	Concentration	cells/mL	R6	Lower Right	---	P01.R1	
Stat	1.70E+06	Custom Expression						[[R6.Concentration.UL]]*[[{DILUTION}]]

Labeling Plot Corners

You can add custom labels to the corners of any plots. Default labels already appear in plots with quadrant markers, if you select **Show on plot** when setting up the quadrant using the New Quad Stat Marker option.

- Click the **New Stat Marker** icon in the plot tool bar and select **Edit Plot Corner Labels**.

The Edit Plot Corner Labels dialog appears.

Labels for quadrants.

- If you are adding labels to a plot with quadrant markers, click the default [count] label and type a new label. If you are adding labels to a plot without quadrant markers, simply type the label in the corresponding box.
- Click **OK**. The labels appear in the corners of the plot.

Group Stats Window

The Group Stats window displays the statistical values for *all* samples in the data set (or group). To display the Group Stats window, click the **Show Group Stats** icon in the main tool bar or select **Tools > Show Group Stats** from the menu bar.

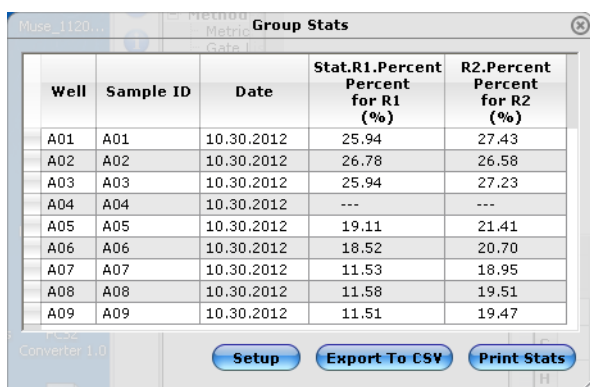

Well	Sample ID	Date	Stat.R1.Percent for R1 (%)	R2.Percent for R2 (%)
A01	A01	10.30.2012	25.94	27.43
A02	A02	10.30.2012	26.78	26.58
A03	A03	10.30.2012	25.94	27.23
A04	A04	10.30.2012	---	---
A05	A05	10.30.2012	19.11	21.41
A06	A06	10.30.2012	18.52	20.70
A07	A07	10.30.2012	11.53	18.95
A08	A08	10.30.2012	11.58	19.51
A09	A09	10.30.2012	11.51	19.47

- Click **Setup** to customize the stats listed in the Group Stats window.
- Click **Export To CSV** to export the group stats to a comma-separated values file for analysis using a spreadsheet program. Select the location, enter a file name, and click **Save**.
- Click **Print Stats** to print the statistics listed in the table.
- To copy the window to the clipboard, right-click in the window and select **Copy to Clipboard**.

Group Stats Setup Window

To customize the statistics that are listed in the Group Stats window, click **Setup**. The Group Stats Setup window appears. To remove a column, remove the “Show” check mark for the selected parameter(s) and click **Done**. The Group Stats window is updated.

You can reorder the rows by clicking the far-left box of the row and dragging the row up or down.

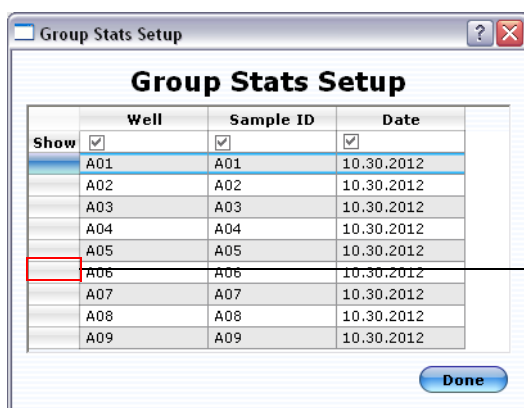

Well	Sample ID	Date
<input checked="" type="checkbox"/>	A01	10.30.2012
<input type="checkbox"/>	A02	10.30.2012
<input type="checkbox"/>	A03	10.30.2012
<input type="checkbox"/>	A04	10.30.2012
<input type="checkbox"/>	A05	10.30.2012
<input type="checkbox"/>	A06	10.30.2012
<input type="checkbox"/>	A07	10.30.2012
<input type="checkbox"/>	A08	10.30.2012
<input type="checkbox"/>	A09	10.30.2012

To reorder the rows, click the box to the far left of the row and drag the row up or down in the list.

Exporting Results

Exporting guava InCyte™ Results to a Spreadsheet File

For each AnalysedGroup, you can export the results to a comma-separated values (CSV) file for analysis using a spreadsheet program such as Microsoft Excel. The CSV file will contain the following statistics: Group name, Stat Type, Parameter, Stat gate, Control gate, Log Display, Max, Threshold Max%, Threshold Max, Threshold Min%, Threshold Min. In addition, each sample well will include a derived statistical value, its unit of measurement, a control well (if applicable), the well's sample ID, and the FCS 3.0 file from which it was derived.

- 1 Right-click on any well and select **Export Heatmap Stats to CSV**.

If the HeatMap legend is divided into multiple sectors, then data from each sector will be exported. If you wish to export results for a single sector (or AnalysedGroup), first click on the specific sector in the legend, then right-click the well and select **Export Heatmap Stats to CSV**.

To export the group stats to a CSV file, refer to “Group Stats Window” on page 4-32.



- **NOTE:** You can copy and save any of the plots, HeatMap, or IC-50 graphs by right-clicking, then selecting Copy To Clipboard.

Exporting guava InCyte™ Results to FCS and List-Mode Files

You can export guava InCyte™ results from the current run or any sample run to both FCS 2.0 and FCS 3.0 files. The data must have an AnalysedGroup associated with it. One FCS file is saved for each sample acquired. You can analyze both FCS 2.0 and 3.0 files using a third-party flow cytometry analysis application. FCS 3.0 files are exported with all parameters included. FCS 3.0 files with semi-automated or post-acquisition compensation may be compatible with some third-party applications. For more information, contact EMD Millipore Technical Support. You can also export list-mode data files.

- 1 To export analysis results for all sample data within the run to individual FCS 2.0 or 3.0 files, select **File > Export to FCS 2.0**, **Export to FCS 3.0**, or **Export List Mode Data**.

You can also select a specific AnalysedGroup from the Analysed Data Pane and select the appropriate export option from the File menu.

- 2 Select the folder where you want to save the file, and enter a file name. Click **Save**. The samples are numbered sequentially and a number is automatically appended to the file name. For example, if the sample number is A01, the file will be named *filename-1.FCS*, A02 is *filename-2.FCS*, etc.

Compensation

This section provides details on specific compensation adjustments for your stained samples during acquisition. It also includes information on performing post-acquisition compensation and automated compensation on data files acquired with ExpressPlus, ExpressPRo, and InCyte™ only.

Performing Manual Compensation

You can perform compensation before or after acquiring your samples. Use the Compensation Controls to select the radio button for the signal you wish to subtract, then use the slider to adjust how much of that signal to remove from the detector/channel.

Click the **Show Compensation Controls** icon in the tool bar to open the Compensation Controls window.

- **NOTE:** The controls at the far left are for semi-automated compensation only.

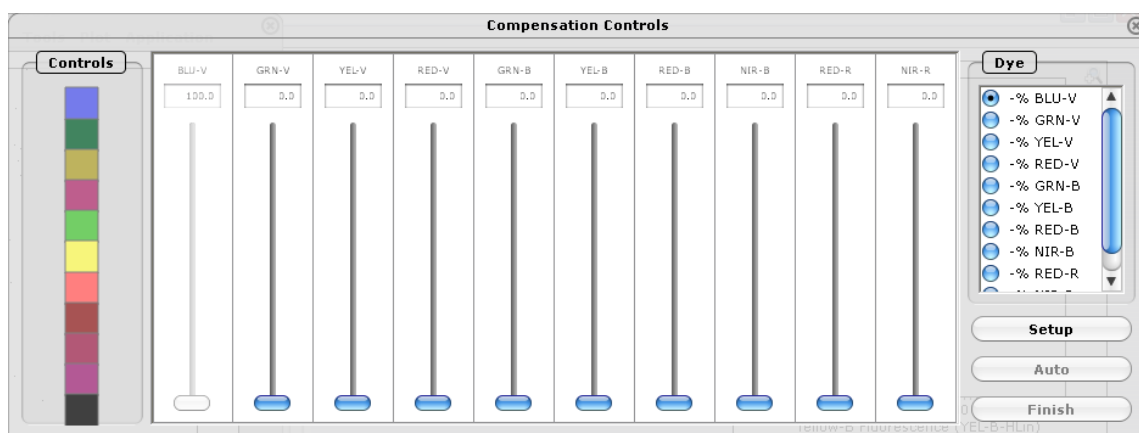

You must check the compensation for each fluorochrome combination you are using. Compensation settings are correct when the center of the stained population is aligned with the center of the isotype or negative control population. Avoid having too many cells touching the axis (overcompensated).

- **NOTE:** Some fluorochromes require very little compensation because they have little overlap, such as PE into the GRN channel (GRN-B – % YEL-B), as shown in the first three plots below; whereas others require much more compensation because they

have more overlap, such as FITC into the YEL channel (YEL-B – % GRN-B), as shown in the last three plots below.

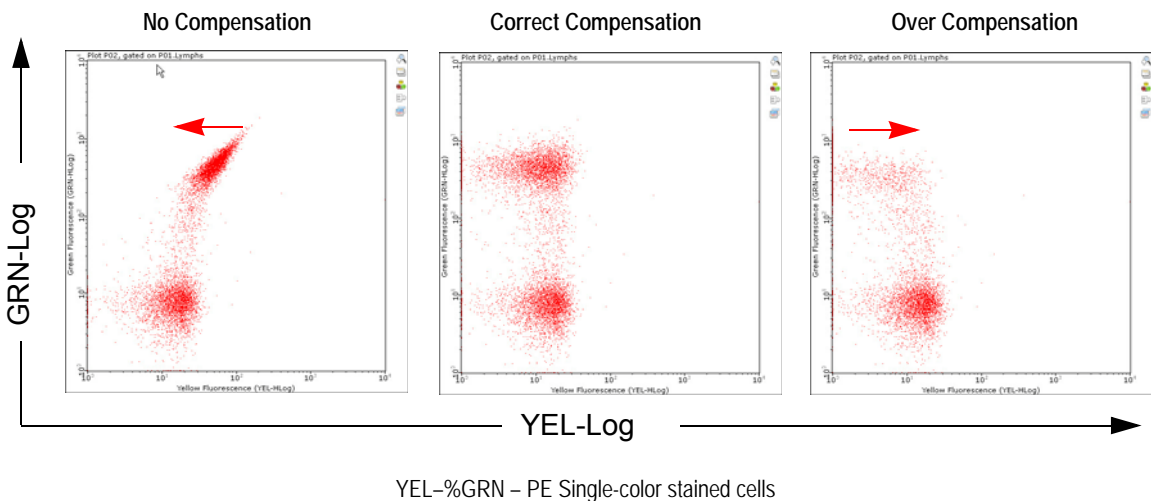
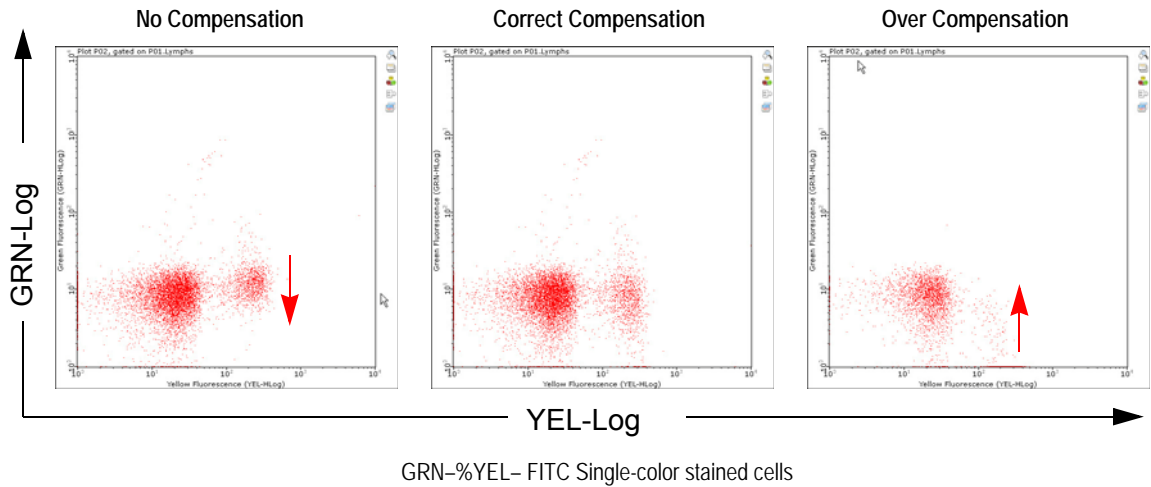

During Acquisition

- 1 Select the radio button for the signal you wish to subtract, then use the slider to adjust the percentage of the signal you wish to subtract from the detector.
For example, to remove the FITC signal from the YEL detector, select the **-% GRN-B** radio button under Dye. Then adjust the YEL slider to remove the FITC signal from the YEL channel (YEL-B – % GRN-B). Next, using the PE single-color control, select the **-% YEL-B** button, and adjust the GRN-B slider to remove the PE signal from the GRN channel (GRN-B – % YEL-B).

Post-Acquisition Compensation

InCyte™ allows you to perform post-acquisition compensation on data files acquired using software modules that have the compensation feature and allow you to adjust compensation during acquisition, such as ExpressPlus, ExpressPro, and InCyte™.

- **NOTE:** You can adjust compensation only; you cannot adjust gain settings.



- 1 Open the FCS file from the Analyse control panel and set up the plots.
We recommend using single-color samples, then checking the compensation again with a sample stained with all fluorochromes to fine-tune, if necessary.
- 2 Select the radio button for the signal you wish to subtract, then use the slider to adjust the percentage of the signal you wish to subtract from the detector.
For example, to remove the FITC signal from the YEL detector, select the – % **GRN-B** radio button under Dye. Then adjust the YEL slider to remove the FITC signal from the YEL channel (YEL-B – % GRN-B). Next, using the PE single-color control, select the –% **YEL-B** button, and adjust the GRN-B slider to remove the PE signal from the GRN channel (GRN-B – % YEL-B).
- 3 Repeat for the remaining compensation adjustments for your samples.
 - **NOTE:** The controls at the left of the window are for semi-automated compensation only.

Settings are applied to all samples in the data set, as well as all groups derived from the data set. Adjustments made to a sample within a group, are applied to all samples in the originating data file.

Performing Semi-automated Compensation

InCyte™ allows you to perform semi-automated compensation on data files acquired using software modules that have the compensation feature and allow you to adjust compensation during acquisition, such as ExpressPlus, ExpressPro, and InCyte™. You must have acquired single-color control samples to use the semi-automated compensation feature.

- **NOTE:** You can adjust compensation only; you cannot adjust gain settings.
- 1 To adjust compensation, open the FCS file from the Analyse control panel and set up the plots.
We recommend using single-color samples, then checking the compensation again with a sample stained with all fluorochromes to fine-tune, if necessary.
 - 2 Click the **Show Compensation Controls** icon in the main tool bar to open the Compensation Controls window.
This window is specific for compensation during analysis. It contains a slider for each parameter and a list of controls in the far left panel. These controls correspond to each parameter and the fluorochrome used:

Comp Color	Channel	Laser
	BLU-V	405 nm (Violet)
	GRN-V	
	YEL-V	
	RED-V	
	GRN-B	488 nm (Blue)
	YEL-B	
	RED-B	
	NIR-B	
	RED-R	642 nm (Red)
	NIR-R	
	negative or isotype control	

- NOTE: If it is necessary to gate the data, pair a Method with the data file to create an Analysed Group and set regions and gates. Refer to “Gates” on page 4-22. Otherwise, it is not necessary to create an Analysed Group to adjust post-acquisition compensation.

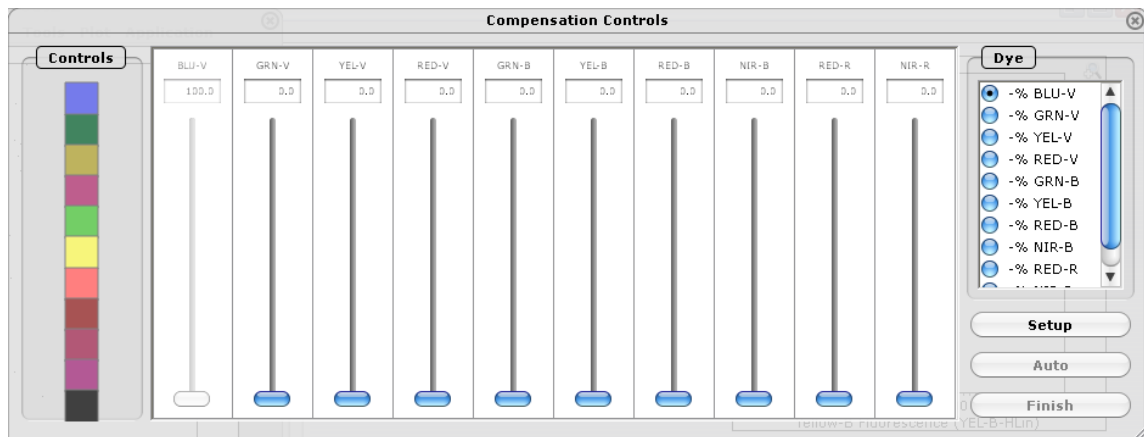

- Click **Setup** in the Compensation Controls window. The application screen changes to display two dot plots on the left with the plate map below, and up to six histograms for each fluorescence channel.
- Adjust the default region in plot 1 so that it encompasses the events of interest.
- Drag the isotype (or negative) control from the plate map to the black square at the far left in Compensation Controls window
- Drag the next control, for example the GRN control (FITC-positive control) from the plate map to the green square at the far left in the Compensation Controls window (see example in figure below).

For this example, the green square turns into a circle and the FITC control data is displayed in the GRN histogram.

- Adjust the GRN histogram marker to include the positive population.

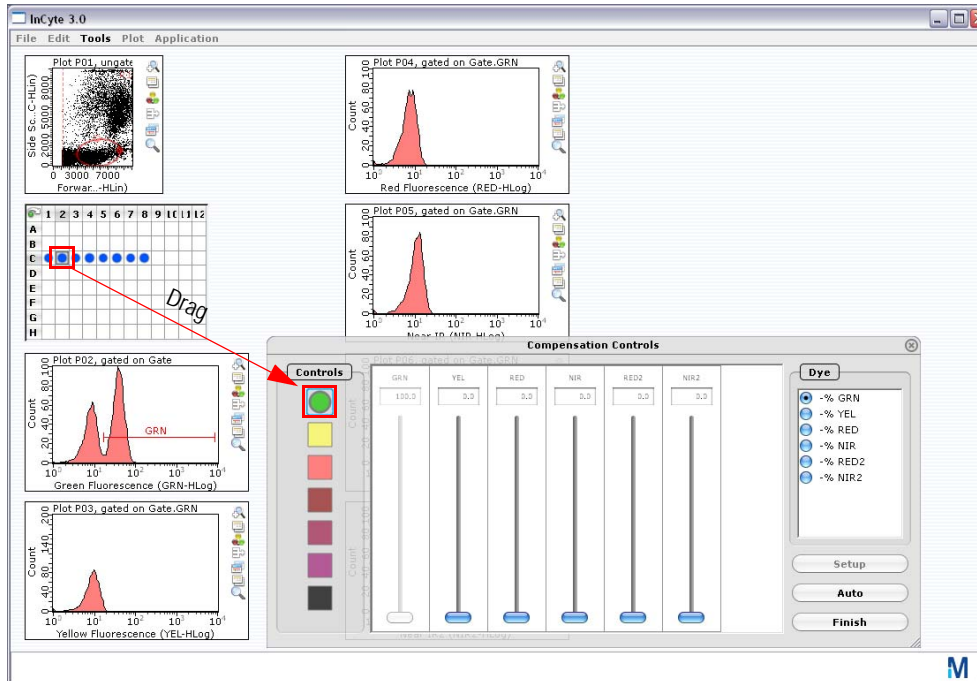

- Drag the next control, for example YEL control (PE-positive control) to the yellow square. Continue dragging the remaining controls to the corresponding Controls squares and adjusting the markers to include the positive population.
- Check that the markers are correct for the isotype control.
- Click **Auto**. The software automatically calculates the compensation values for each parameter. Settings are applied to all samples in the data set, as well as all groups derived from the data set. Adjustments made to a sample within a group are applied to all samples in the originating data file.
- If you need to adjust compensation further, refer to “Post-Acquisition Compensation” on page 4-35.
- Click **Finish** to return to the analysis display.

HeatMap

HeatMapping provides a colorimetric representation of comparative results at the experiment level. Each Analysed Group is represented by an individual sector in the HeatMap legend. After the completion of sample analysis, individual parameters can be compared over the entire experimental run. A visual representation of the data and the results will appear in the plate map. Well-to-well variations in blue (dark blue = maximum

value, white = minimum value) are based on relative differences in the data as measured on a linear scale.

The plate map can simultaneously display results for up to six Analysed Groups—the same number of sectors that the legend is displaying. Place the cursor over any well to see the result for that Analysed Group. When the HeatMap legend displays more than one sector, the results for every sector will appear within the well pop-up.

- **NOTE:** If the Analysis Method used to create the Analysed Group is new (no regions and/or gates have been defined), the plate map will initially display all wells as dark blue. Perform the analysis on the data before proceeding to HeatMapping.

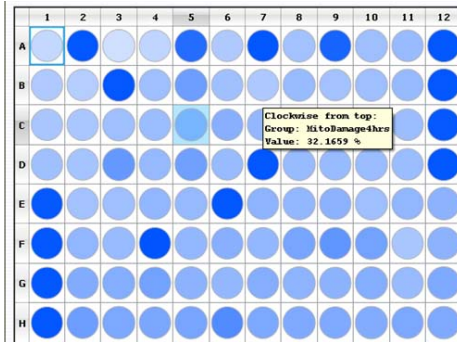

One sector in HeatMap Legend

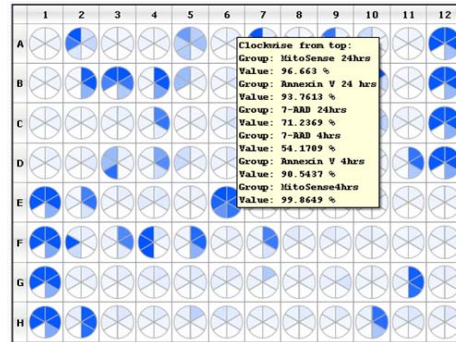

Six sectors in HeatMap Legend

Creating a HeatMap

The following examples show how to use the HeatMap to get a visual and numerical representation of results for a single or multiple parameters from one data file. This example shows a sample stained to detect mitochondrial membrane potential, cells undergoing apoptosis, and dead cells.

Single-Parameter HeatMap Using a Region or Gate

- 1 Open the Analysed Group.

You can also open an FCS data file and perform the analysis for the populations you are interested in. See “guava InCyte™ Analysis” on page 4-13, for information.

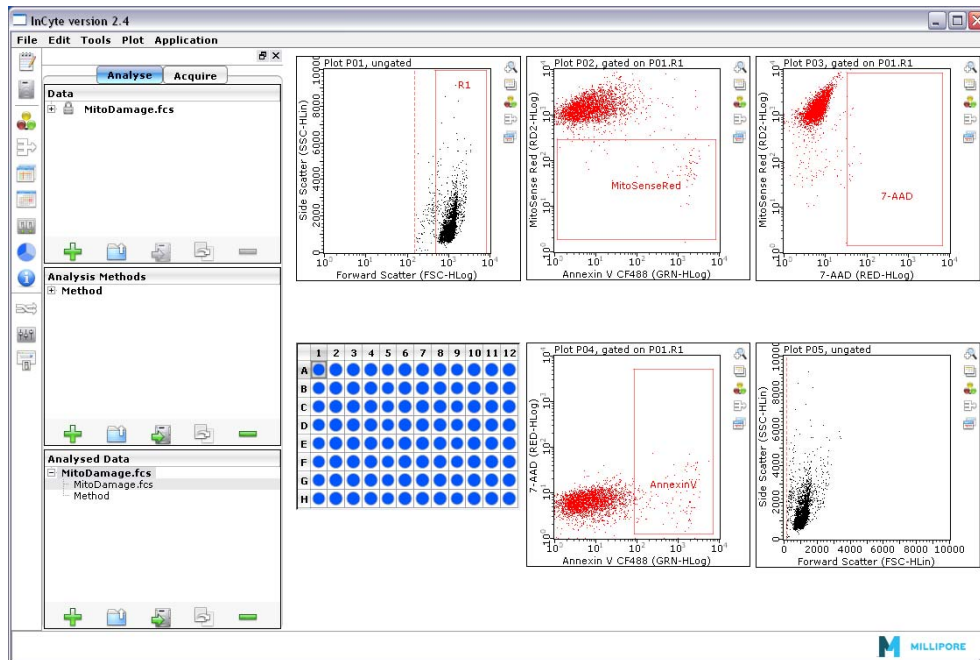

Jurkat cells were stained with FlowCollect MitoDamage kit to look at mitochondria membrane potential (MitoSense Red), apoptosis (Annexin V CF488), and cell death (7-AAD). R1 was created for cell population, then applied to plots 2-4. Three regions were created for each population of interest.

- 2 Select the gate of interest, then click and drag it to the Analysed Group in the Analysed Data pane. Click **OK** to accept the new gate name, or change the name.

As you start to drag the gate, a gray box appears at the cursor. Drag the gate to the Analysed Group and a plus sign (+) appears on the cursor. Drop the gate in the Analysed Group.

- **NOTE:** You can also use the HeatMap legend by dragging the Analysed Group and the gate to the legend. Then, to update the analysis, simply drag a new gate to the legend. The plate map will update automatically.

After the gate is applied to the Analysed Group, the wells will change to varying shades of blue, depending on the population percentages. Place the cursor over any well to see value for that well.

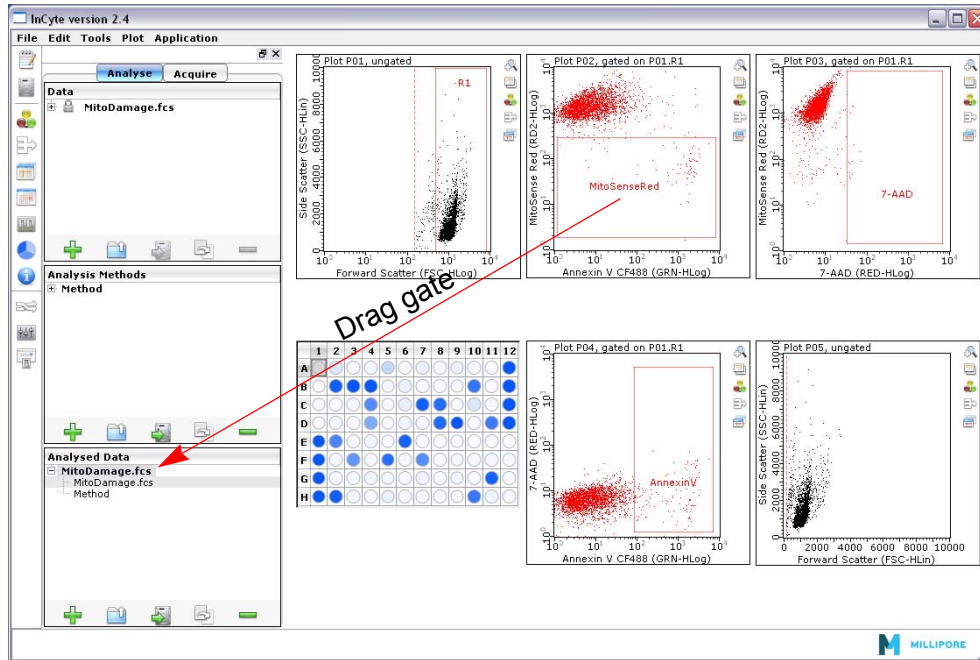

MitoSense Red region is dragged to the Analysed Group. Plate map displays well-to-well variation of relative percentage of mitochondrial membrane potential among samples.

- 3 To change the metric and/or threshold, see “Metrics” on page 4-43 and “Thresholds” on page 4-43.
- 4 To save the HeatMapped Analysed Group, select it and click the Save button (3rd) in the pane. Navigate to the location where you wish to save it, enter a file name, and click **Save**. The Analysed Group will be saved as an FCS file and will contain the Method (regions, gates, metrics, and stats), as well as the data and the instrument settings.

Multi-Parameter HeatMap Using a Region or Gate

The following example is the same as the single-parameter HeatMap shown above. In this example, three Analysed Groups are created to view and compare the results for three different populations simultaneously.

- 1 Open the Analysed Group.
- 2 To compare multiple parameters from one FCS file, duplicate the Analysed Group. Select the Analysed Group, then click the Duplicate button (4th button) in the pane.

For this example, the Analysed Group was duplicated twice to obtain results on three populations.
- 3 Select the first Analysed Group, then click to select and drag the gate of interest to this Analysed Group. Click **OK** to accept the new gate name, or change the name.

- 4 Select the second Analysed Group, then click to select and drag the next gate of interest to this Analysed Group.
- 5 Repeat by dragging the remaining gates to the Analysed Groups.
- 6 (Optional) To change the name of an Analysed Group, double-click it and type the new name.
- 7 Click the Pie Legend icon in the tool bar on the left side of the application window to display the HeatMap legend. Select the number of sectors (N) to display.
- 8 Click and drag the Analysed Groups to the appropriate sectors. Then, click the center circle in the legend to display the results for all populations of interest in the plate map.
 - **NOTE:** When multiple sectors are displayed, no data is shown in the plots and you cannot modify any Methods (add regions, move gates, etc). To modify individual Methods, click on the sector you wish to update.

For more information on the HeatMap legend, see “Pie Legend” on page 4-5.

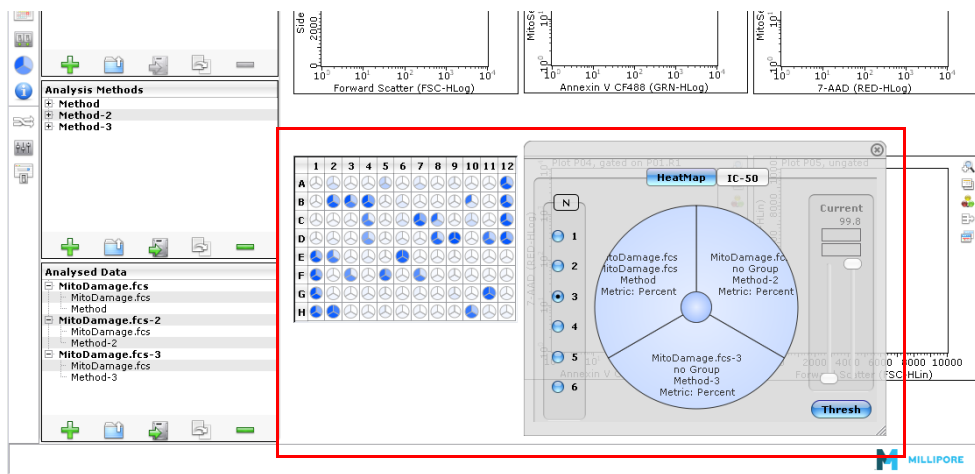

- 9 The plate map shows each well with the number of sectors used for analysis. Place the cursor over any well to see all the values for that well.
- 10 (Optional) To clear a sector, right-click on the sector in the HeatMap legend and select **Clear sector**.
- 11 To change the metric and/or threshold, see "Metrics" and “Thresholds” on page 4-43.
- 12 To save the HeatMapped Analysed Groups, select one and click the Save button (3rd) in the pane. Navigate to the location where you wish to save it, enter a file name, and click **Save**. The Analysed Group will be saved as an FCS file and will contain the Method (regions, gates, metrics, and stats), as well as the data and the instrument settings. Repeat for the remaining groups.

Single-Parameter HeatMap Using a Statistic or Expression Stat

The following example shows how to use the HeatMap to get a visual and numerical representation of results for a single or multiple parameters from one data file.

- 1 Open the Analyzed Group.
- 2 If necessary, create a stat region or a statistic for any region created. For more information on creating statistic gates and statistics for regions see “guava InCyte™ Analysis” on page 4-13.
- 3 Click the Pie Legend icon in the tool bar on the left side of the application window to display the HeatMap legend.
- 4 Select the statistic of interest, then click and drag it to the Analyzed Group in the Analyzed Data pane. Click **OK** to accept the new gate name, or change the name.

Thresholds

The Workspace contains a dual-barred threshold tool for setting upper and lower limits on statistical values. The threshold bars can be used to set limits on a single AnalysedGroup at a time (the one that is displayed in the plate map). If the HeatMap is displaying multiple sectors, the threshold feature is disabled.

Above the threshold panel is the maximum derived value for a given data set. Each slider tool is based upon a % scale where the minimum value (0 is lower limit) is Zero and the maximum value (100 in upper limit) is defined by the maximum value derived from the analysis. Simply slide the bars up or down to set boundaries for data display.

In addition, any well can be selected to represent the MAX value. To set a MAX, right-click on a well and select **Use as Max** from the menu. The new max value will also be displayed at the top of the threshold panel.

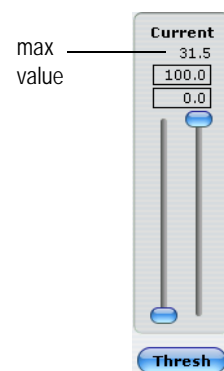

Metrics

Metrics are the statistical parameters applied to a set of gated events. Applying a metric results in the calculation of a numerical value for each well/sample. These values are compared across a given data set and determine the well-to-well variability in color displayed in the plate map. There are six metrics from which to choose:

- **Percent (%)** - Percentage of events within a given gate relative to the total number of events displayed within the originating plot.
- **Count** - Number of events within a given gate.
- **Concentration** - Event count for a gate as a function of the volume of sample acquired (events/uL).
- **Mean** - Mean fluorescent intensity (MFI) for a set of gated events. If derived from a dot plot, the mean value applies to the parameter associated with the x axis. (For log scale, the mean is geometric; for linear scale, the mean is arithmetic.)

- **Median** - Median fluorescence for a set of gated events. If derived from a dot plot, the median value applies to the parameter associated with the x axis.
- **Mean Ratio** - A measure of the fluorescence intensity for a set of gated events as defined by the following: $\text{ratio} = \text{MFI}_{\text{well } X} / \text{MFI}_{\text{control well}}$. The control MFI may be derived from a single sample or represent the average value from a set of control samples. To apply a mean ratio, select **Mean Ratio**. Using the plate map, select the appropriate control well(s) and drag to the corresponding legend sector. This well's value is used as the denominator in the above equation. You must select a control well as the denominator to get a mean ratio.

Changing the Metric

The default metric for a new Method is percent. To select a different metric, double-click the metric in the Analysis Methods pane, then open the drop-down list to display the Metric list. Select a metric to apply it as the statistical parameter for that Method. Once selected, the newly chosen metric will replace the previous one. If you are heatmapping and the corresponding Method occupies a legend sector, the plate map will automatically update to reflect the change.

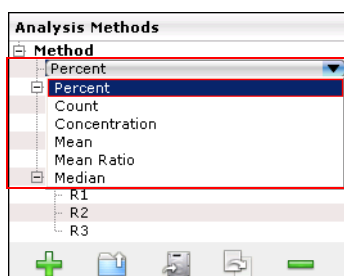

To change the metric, double-click the metric in the Method and select the new metric.

IC-50/EC-50

Understanding the kinetic characteristics of a given compound's mode of action is important for determining efficacy, toxicity, and dosage. Assays measuring parameters such as apoptotic status or protein expression are commonly used to obtain this information. Use the IC-50 application to create curves based on the relationship between concentration and response, where response is measured by changes in the statistical parameter for the applied Analysis Method. IC-50 (or EC-50) values are derived directly from the calculated curves.

- The EC50 value is the concentration of a drug, antibody, or toxicant which induces a response halfway between the baseline and maximum following a specified exposure time.
- The IC50 is a measure of the effectiveness of a compound to inhibit or reduce a measurable response by 50% relative to the baseline (which in this case is a maximum value) and absolute minima.

Creating an EC-50 or IC-50 Curve

- 1 To determine the EC50 value for a given compound, pair a data file with a Method, then define the regions and gates.
If the compound-specific sample set is part of a larger data set, create a group to define this specific subset (see “Creating a Group” on page 4-46). Then drag the group to the legend sector replacing the original FCS data file.
- 2 Click the **Show Pie Legend** icon in the tool bar to open the workspace. Click **IC50** at the top of Workspace.
A graph appears where x and y axes are defined as Concentration (log10 scale) and response level % (linear), respectively.
The y coordinates correspond to the numerical values derived from the AnalysedGroup. Values are converted to a relative scale where the maximum derived value is set to 100% on the y axis.
The x coordinates represent the actual compound concentrations used at each step in the titration. The axis display is open and set automatically from the range of concentrations used.
- 3 To set the x-axis values for the curve, click the **Setup** button.
The setup dialog appears, displaying the wells used in the analysis, the Sample ID, and Quantity.

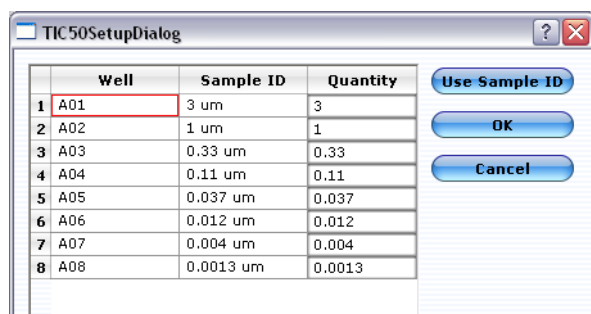

The Sample ID is derived from the original FCS file. If a sample ID was not entered for each well, the default well name appears (A01, A02).

- 4 Enter the Quantity (concentration) for each well. Quantity defines the x-axis values for the graph. These are user-defined and must be entered for each curve.
If, during acquisition, you enter a concentration as the sample ID, you can click the **Use Sample ID** button to enter the Quantity. Characters before the “space” in the ID are used for the quantity. For example, if your sample ID is “3 um staurosporine,” the 3 is used for the quantity. You can also type the values into the Quantity fields. Enter the actual number (.01, .001, .0001) or use scientific notation (1e-2, 1e-3, 1e-4).

- Click **OK** to display the graph.
The EC-50 (IC-50) value is marked by a bold + on the curve.

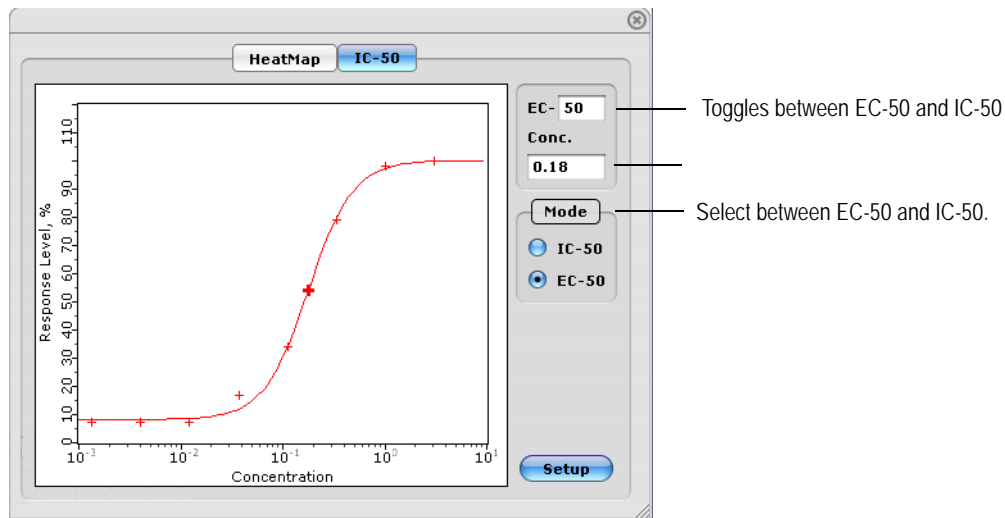

You can make the following adjustments to the data:

- Change the target value (from 20–80). For example, instead of viewing a graph where 50% of the effect is observed, set the EC or IC value to 25 to see where 25% of the effect is observed.
- The Conc field provides the numerical value for the EC-50 point, in this case 0.16.
- Select between EC-50 and IC-50.

Special Features

Creating a Group

A group is a user-defined set of samples from one or more FCS files (or data sets). Grouping allows you to extract and analyze a subset of samples from the data set(s). You can also use grouping to apply different Methods to subsets of data that are part of a single FCS file, to get different statistics, for example.

To create a group:

- Select the FCS data file in the Data pane.
The plate map displays the samples acquired in that file.

- 2 Drag the cursor across the appropriate wells in the plate map, right-click the selected wells, and choose **Create group** from the menu.



To select non-consecutive wells, press the Ctrl key while clicking to select wells. The order that you select and add the wells to the group is the order that they will be in the group.

The group name appears under the original FCS file in the Data pane. To rename the group, double-click the name and type in the new name.

To add additional samples to an existing group, select the wells and drag them to the group in the Data pane.

- **NOTE:** You can combine samples from different FCS files; however, if you select the same/overlapping wells, the plate map and plots will display only the first of the overlapping well(s) selected (eg, the first A01 selected).

- 3 To remove an individual well, right-click it and select **Remove Item**. The deleted well is removed from the group and appears as an empty square in the plate map. Wells can be deleted only from groups, not from the original FCS file. To delete a group, select it and click the **Delete Group** icon in the Data pane.

- **NOTE:** Use the **Duplicate Group** icon in the Data pane to make a copy of a group.

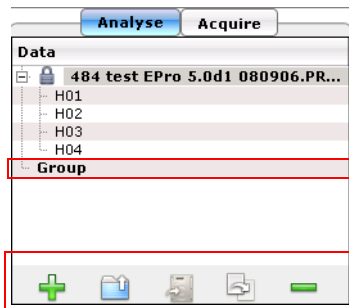

Group under the data file from which it was created.

You can also use the icons at the bottom of the Data pane to create, open, save, duplicate, and delete a group.

Data Pooling

During analysis you can combine the data from multiple samples into a single sample. This can be useful when analyzing rare events.

To pool samples, you must first pair a data file with a method to create an analyzed group.

- 1 Click a well that you wish to pool data from other wells into, then drag to select the other wells.
- 2 Right-click the selected wells and choose **Pool Samples** from the menu.

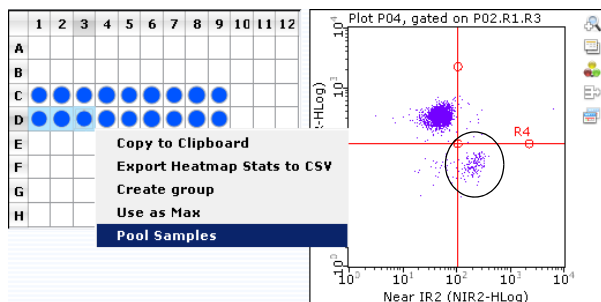

Example:

D01 is selected and cursor is dragged through D03. Right-click and select Pool Samples. Wells D02 and D03 now appear with 01 label.

The data combined from all selected wells appears in the plots. The wells appear in the plate map with the label number of the first selected well.

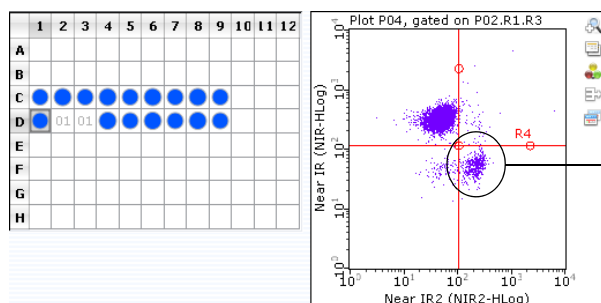

Combined (pooled) data for D01 through D03 appears in the plots.

To see the new combined number of events for a given population, open the Current Run Stats window by selecting **Tools > Show Current Run Stats**. If stats have not been created, click the New Stat Marker icon to the right of the plot and select **New Stat for Rx**. Select Count as the Metric and click **OK**.

- 3 To “unpool” the data, click and drag to select the wells (in any order). Right-click the selected wells and choose **Cancel Pooled Samples**.

Overlaying Histograms

The histogram overlay feature allows you to superimpose histograms from multiple samples derived from one data file. By selecting a different color for each sample, you can see the different sample data overlaid within the same plot. Each histogram plot has its own overlay list.

- 1 Click the **Edit Overlay List** icon (last icon in the tool bar of the histogram plot). The Overlay Setup dialog box appears with the currently displayed sample well listed as base in the far-left column and *<current>* under Sample ID.

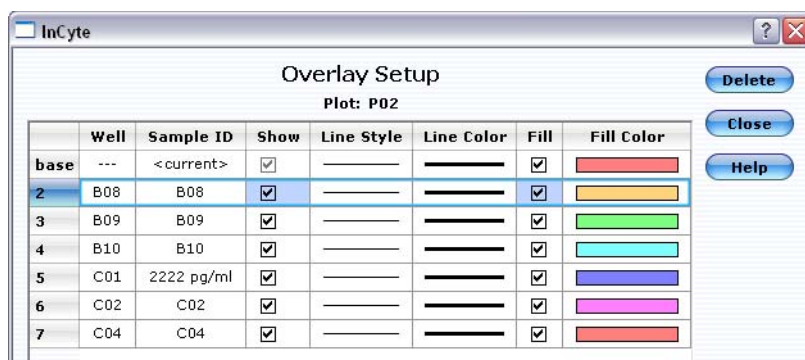

- 2 To add samples to the overlay list (and plot), drag a well directly from the plate map to either the histogram plot or the Overlay Setup dialog box. To select multiple wells, drag to select wells or use the Ctrl key to select non-consecutive wells.

The plot will display the selected sample data in the designated colors. When you overlay plots, any markers you had previously set, as well as the stats, apply to the base plot only. The overlays are derived from the same gate as the initial plot. You can also change the parameter displayed by clicking the x-axis label and choosing a different parameter.

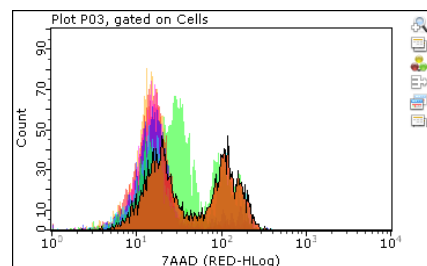

- To change the overlay order, click the number (or “base”) in the left column and drag it to a new location in the list.
 - To remove data for an individual sample, click to select the well in the list and click **Delete**.
 - To hide the data for an overlay from the plot, click to remove the check mark from the Show check box.
 - Click Line Style, Line Color, and Fill Color to change the appearance of the overlay.
- **NOTE:** You cannot overlay sample data with different plot parameters. A message will appear informing you that some samples do not have the required parameters.

Printing Results

Before printing results, use the Print Preview option to customize the information that prints.

- 1 If necessary, set up the page orientation, paper size, and margins by selecting **File > Page Setup**.
- 2 Select **File > Print Preview**.

The Print Preview window appears.

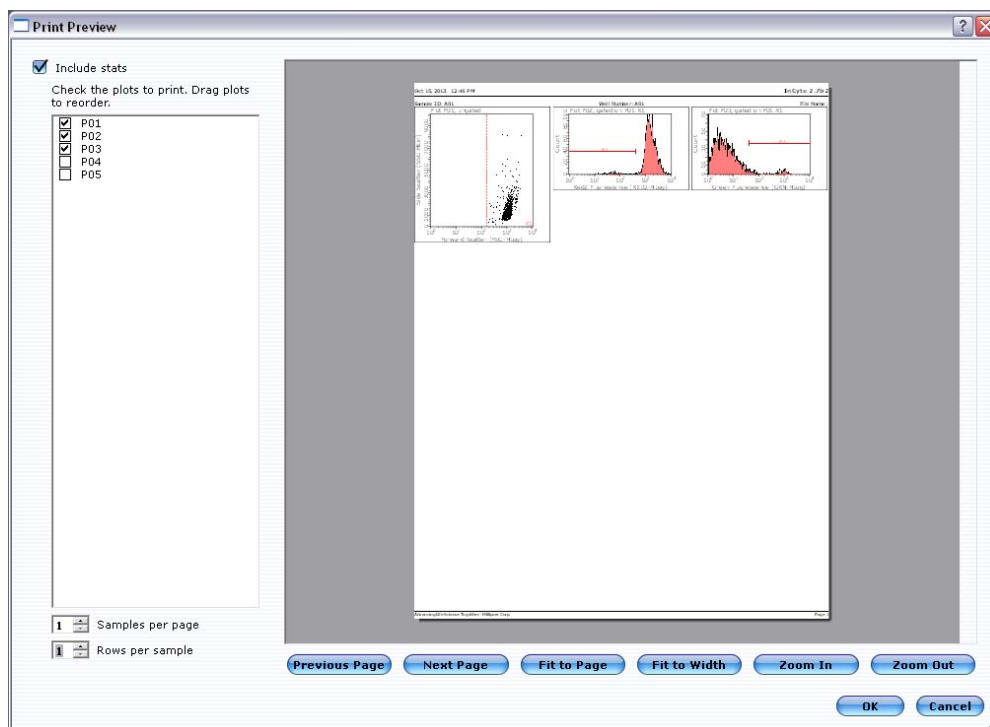

- 3 Select how you wish the results to print:
 - Select the plots to print by clicking the check box next to the plots. The selected plots will print in the order they are listed. If you wish to reorder the plots in the list, click and drag a plot to a new location in the list.
 - Check to include the statistics. The stats will appear in a table at the end of the printout.
 - Select how many samples you wish to print per page.
 - Select how many rows you wish to print per sample.
 - To scroll through the pages, place the cursor on the page, then click and drag (the hand) to move the page.

guava InCyte™ Troubleshooting

Problem	Possible Cause	Solutions
InCyte™ will not launch; prompts you for an unlock code.	An unlock code was not entered or was entered incorrectly.	Contact EMD Millipore Technical Support for the unlock code.
InCyte™ starts in Analysis mode. Acquisition mode is not available.	Communication problem between instrument and laptop.	Ensure USB cable is connected between instrument and laptop.
Gates and/or events in plots disappear.	<ol style="list-style-type: none"> 1. Data file or Method is selected. 2. Data was acquired in tubes. 3. More than 96 samples were acquired. 	Click on the AnalyzedGroup in the Analysed Data pane to display data and gates.
Few events, as indicated in Cell Count section of Sample Information control panel.	<ol style="list-style-type: none"> 1. Clogged flow cell. 2. Insufficient sample volume. 3. Cells in suspension have settled. 	<ol style="list-style-type: none"> 1. Remove sample, load bleach, click Backflush. Follow with Quick Clean. 2. Minimum sample volume is 90 µL. 3. Click Abort. Remove sample, mix, reload, and reacquire.
Unexpected events appearing in plots.	Instrument settings not optimal. Acquiring debris.	Adjust settings so debris is below threshold.
FSC Count under Cell Count shows events, but the events appear in the wrong places in plots.	<ol style="list-style-type: none"> 1. Sample was not stained. 2. Cell lysis. 	<ol style="list-style-type: none"> 1. Check sample. If necessary, restrain sample from original suspension. 2. Check buffers used to process cells.

Problem	Possible Cause	Solutions
No events, as indicated in Particle Count section of Sample Information control panel.	<ol style="list-style-type: none"> 1. Sample tube or plate not loaded. 2. No cells in sample. 3. Clogged flow cell. 4. Broken flow cell. 5. Sample pump not working. 6. Laser not operational. 7. Loose fitting on minstac tubing (under metal plate). 	<ol style="list-style-type: none"> 1. Ensure tube is loaded and loader assembly is up. 2. Ensure correct sample is loaded. 3. Remove sample, load bleach, click Backflush. Follow with Quick Clean using DI water. 4. Remove flow cell and inspect for damage. Replace if necessary. 5. Run Quick Clean and watch for fluid in waste vial. 6. Allow laser to warm up for 15 min. If laser is not on, contact EMD Millipore Technical Support. 7. Ensure tubing connector is secure.
Events appear in some plots but not in others.	Ensure correct gate is selected for plot in question.	<ol style="list-style-type: none"> 1. Open plot menu, point to Apply Gates and select gate. 2. Check gate definition to ensure it includes the correct regions and operators.
Events appear off scale in dot plots or histograms.	Gains set incorrectly, or samples staining brightly.	Adjust gain setting so positive populations appear on scale. Repeat Adjust Settings with negative sample. Adjust compensation settings.
Cannot resolve dim positive staining from background signal.	Dirty capillary.	Perform at least one cycle of Guava [®] Clean. While acquiring samples, select Clean & Rinse instead of Quick Clean, and if necessary, run it frequently.

Problem	Possible Cause	Solutions
<p>Poor resolution between positive and negative populations.</p>	<ol style="list-style-type: none"> 1. Gains too low to detect fluorescent signals. 2. Incomplete staining with fluorescent probe, or fluorescent probe inappropriate for cell type. 3. Fluorescent probes over-exposed to light, stored improperly, or expired. 4. Non-specific binding of fluorescent probes. 5. Background noise too high. 	<ol style="list-style-type: none"> 1. Adjust settings to increase fluorescent signal. Adjust compensation settings. 2. Ensure positive control is staining adequately and with correct reagent. 3. Refer to reagent package insert for proper storage instructions. Do not expose reagent to excessive light. Do not use expired reagents. 4. If using antibody-based probes, try Fc blocking reagent during staining to minimize non-specific binding. Otherwise, titer the fluorescent probes down to reduce the nonspecific staining. 5. Adjust settings to increase FSC threshold to remove debris. Or, wash stained sample and reacquire.
<p>Poor resolution between positive populations.</p>	<ol style="list-style-type: none"> 1. Incomplete staining with reagent(s). 2. Too much reagent in staining tube. 3. Fluorescence background too high. 4. Gain too high causing signal to bleed into other parameters. 5. Gain too low to optimally detect positive signal. 6. Background noise too high. 	<ol style="list-style-type: none"> 1. Check expiration date and amount of reagent(s) used in staining. 2. Washing cells may remove residual reagent. 3. Washing cells may remove residual reagent. 4. Adjust settings to reduce gain. Adjust compensation settings. 5. Adjust settings to increase gain. Adjust compensation settings. 6. Adjust settings to increase FSC threshold to remove debris. Or, select one of the fluorescence parameters as the threshold.

Appendix A

Administrator Features

Setting up Access Control

guavaSoft™ software, version 3.1, supports features which allow a laboratory administrator in controlled environments to restrict users from access to certain features of the guava easyCyte™ System to help ensure that standard procedures are followed correctly. Users whose access has been restricted cannot change instrument or analysis settings, and may only operate the guava easyCyte™ System according to previously-saved Settings files or the instrument default settings.

Who Should Read This Section on Administrator Features

By default, after installation there are no access control restrictions, and the default “GTI” user account has access to all features of the software. If such unrestricted access is sufficient for your needs, then no further steps are necessary and you may begin using the software.

You should read this section if:

- you want to use access control in your laboratory or environment, or
- you want to create new user accounts, or
- you are a network administrator and need information about the guava® system environment in order to create guava® user accounts in a manner consistent with your local security policy

We recommend that you contact your local network administrator for help in setting up user accounts and access control.

Access Control Levels

guavaSoft™ software, version 3.1, supports three levels of access control, *Administrator*, *Supervisor*, and *Operator*. Each user account under the Windows® operating system has one of these levels, which is assigned by the lab administrator on a case-by-case basis. A higher access control level always has privileges of all access control levels below.

Administrator-level user accounts have unrestricted access to all features of the software including the “Administration Configuration,” and are assumed to be guavaSoft™ software Administrators who know how to properly configure all features of the software for supervisor-level and operator-level users.

Supervisor-level user accounts have unrestricted access to all features of the software except the “Administration Configuration” (see page B-13) and are assumed to be expert users who know how to properly use all features of the software at the supervisor and operator levels.

All user accounts can:

- perform the Adjust Settings step
- retrieve instrument settings files
- start new data sets
- run the easyCyte™ System and acquire data (entering all relevant information such as sample IDs, number of events to acquire, and dilution factor and original volume, when applicable)
- perform Quick Clean, Backflush, and Cleaning operations
- run the easyCheck™ Procedure
- abort an acquisition, when necessary
- export data to FCS 2.0, 3.0, or CSV format
- add comments to event log
- view event log file

Operator-level user accounts cannot:

- change instrument settings (FSC gain, PM1 or PM2 voltages, pump speed)
- adjust markers or gates
- make any adjustments during the Adjust Settings step
- use Next Step, except to (a) finish Adjust Settings, or (b) terminate a normal acquisition
- save instrument settings

Before Setting Up Access Control

The guavaSoft™ software, version 3.1, installer automatically creates the three different guava® User Groups under Windows, namely, GuavaAdmin, GuavaSupervisor, and GuavaOperator. The correct access to the various guava® files needed to function properly are also automatically set up by the installer.

- **IMPORTANT NOTE:** If you plan to connect the system to a network, be sure to contact your local network administrator for help, since the procedures described here may need to be modified in order to comply with security policies in effect for your local network.

“First-Time Setup After Installation” describes steps which need to be taken only once, after installation of the software. It explains how to set up the guava® Settings Files folder access control.

“How to Create A New User Account” describes how to create a new user account.

“Assigning a guava® Access Control Level to a User Account” describes how to assign the access control level (Administrator, Supervisor, or Operator) to a user account.

First-Time Setup After Installation

This section shows you after installation, the three User Groups, GuavaAdmin, GuavaSupervisor, and GuavaOperator are automatically created. The steps to set up the folder for the guava® Setting Files are also described in this section.

The GuavaAdmin group is used by guavaSoft™ software to allow the guava® Administrator to configure the “Administration Configuration.” This option is available from the guavaSoft™ software main menu to a guava® Administrator only. The GuavaAdmin group consists of only those users who are to share responsibility for administering Access Control. All members of the GuavaAdmin group should also be a Windows Administrator. Only these users (or a Windows administrator) will be able to assign or change the access control levels for other users.

Three User Groups Automatically Created Upon Installation

- 1 Log on as administrator. (No password is required by default.)

- Right-click My Computer and select **Manage** from the menu. The Computer Management window appears. Expand the content of the “Local Users and Groups” folder and click on the “Groups” folder.

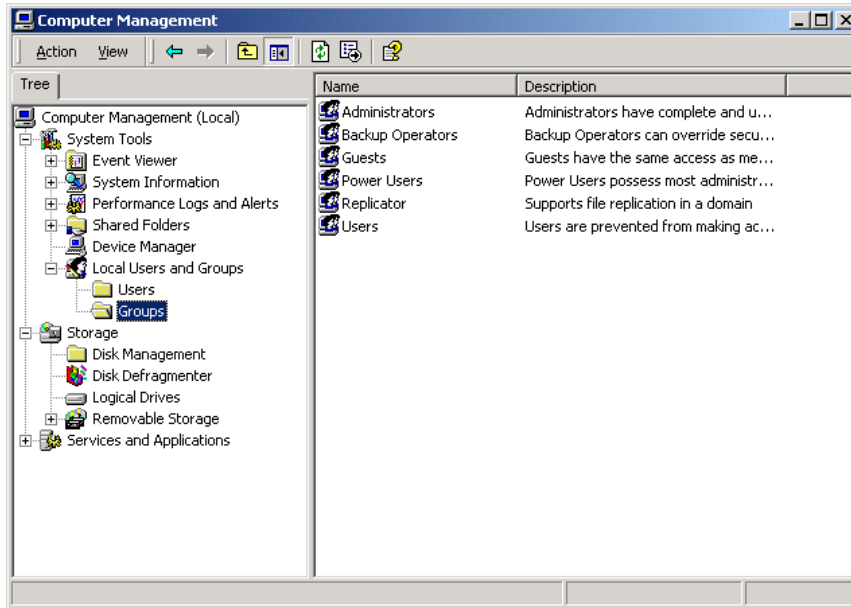

Create the *guavaSoft™* “*guavaSettings*” Folder

- Double-click My Computer. Double-click Shared Documents. Create a new folder in the Shared Documents folder called *guavaSettings*.
 - NOTE:** If using Windows® 7 OS, the Shared Documents folder does not exist under My Computer. Request that your IT department create a *guavaSettings* folder that is accessible to the appropriate users.

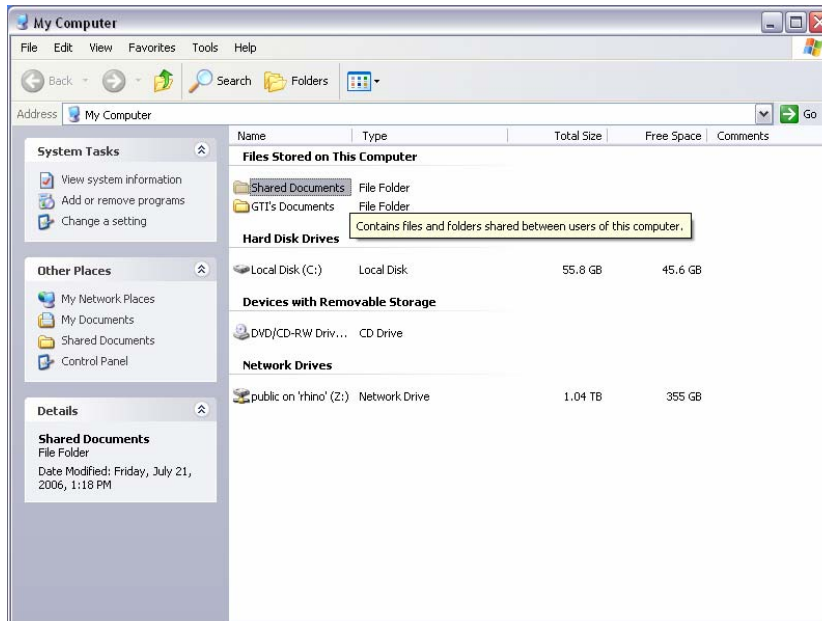

How to Create A New User Account

- 1 Log on as administrator.
- 2 Right-click My Computer and select **Manage** from the menu.
- 3 Find Local Users and Groups and click to expand its contents. Click the Users folder.

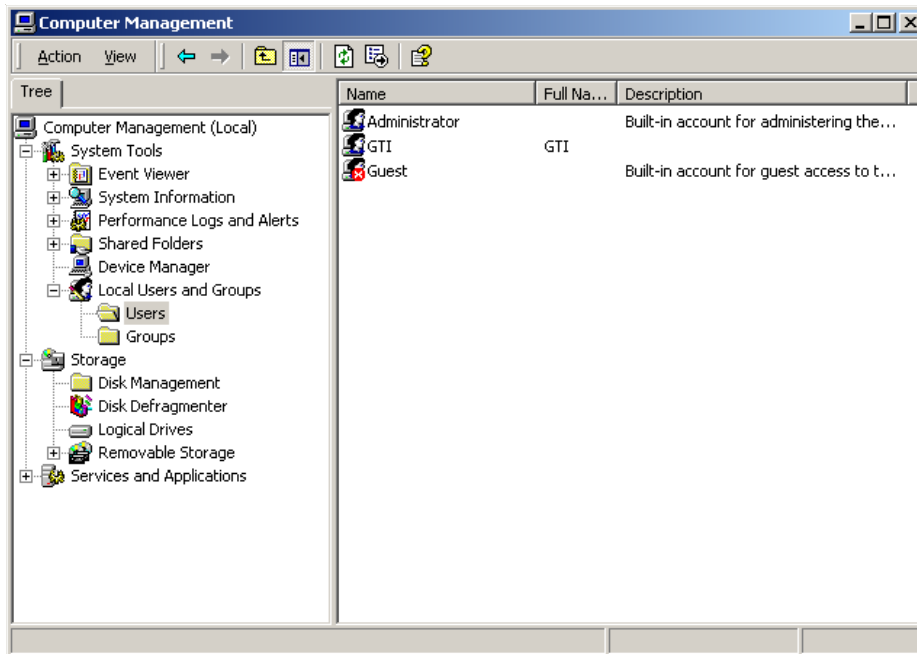

- 4 Select **New User** from the Action menu in the menu bar at the top of the window. The New User dialog box appears.

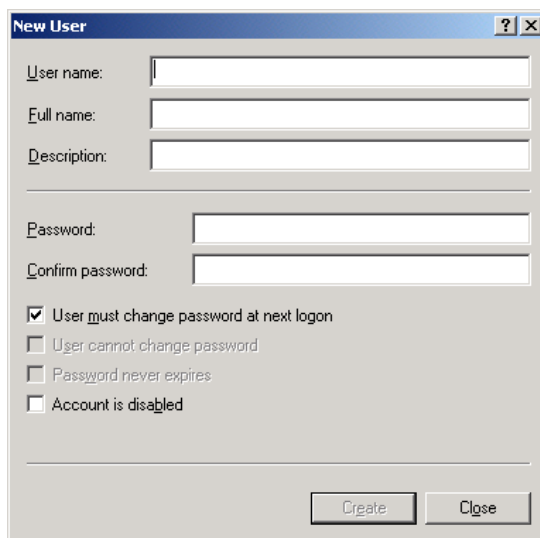

- 5 Enter a user name to be added to the system. Type in a full name (first and last), a password and confirmation, and a description. In the example below, a user account “User1” for “Joe Smith” in “R&D” is created.

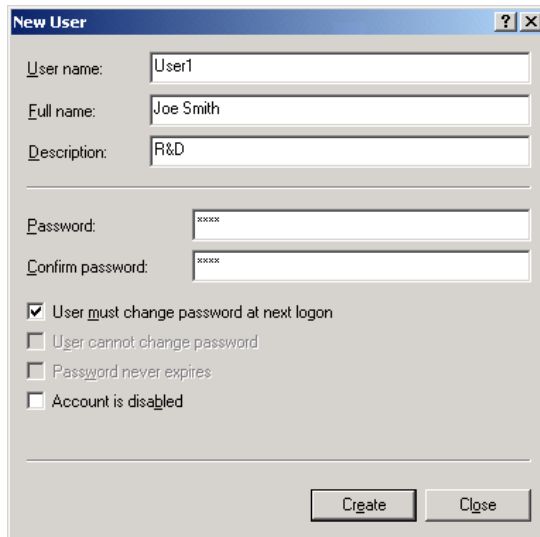

- 6 Click **Create**. You may continue adding more users by repeating the steps starting with step 4. Click **Close** when you are finished adding users.
- 7 You will need to assign each user to the proper access control group. Proceed to “Assigning a guava® Access Control Level to a User Account” for this information.

Assigning a guava® Access Control Level to a User Account

This section shows you how to assign the Access Control level to a user account for guavaSoft™ software. You do this by assigning the user to one of the groups created in “First-Time Setup After Installation” on page A-3.

If you want the user to be able to administer Access Control for other users or to be able to configure the “Administration Configuration,” (normally, very few users should have this right), add the user to the GuavaAdmin group as shown below. Also make sure that the user you have added to the GuavaAdmin group is also a Windows Administrator.

In a similar manner, a user account can be assigned to have either Supervisor- or Operator-level access control simply by adding the user to either the GuavaSupervisor or GuavaOperator group, respectively, as shown below.

Be careful not to assign a user to more than one guava® group. The higher Group privilege takes precedence, which may not be what you want.

- 1 Log on as a Windows Administrator.
- 2 Right-click My Computer and select **Manage** from the menu.
- 3 Navigate to the Groups folder under “Local Users and Groups.”

How to Give a User Account GuavaAdmin-Level Access

- 1 Right-click on the GuavaAdmin group and select **Properties**.
- 2 Click **Add** in the GuavaAdmin Properties window.
The Select Users window appears.

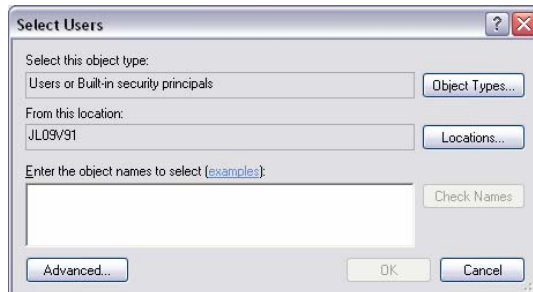

- 3 Enter the user login name for the administrator and click **OK**.
 - 4 Repeat these steps to add additional administrators.
- **NOTE:** If a user in the GuavaAdmin group is NOT a Windows Administrator, you can add the user to the Administrators group:
 - Right-click My Computer and select **Manage** from the menu.
 - Click the Groups folder under the “Local Users and Groups” folder.
 - Right-click on the “Administrators” group in the right side of the window and select **Add to Group** from the menu.
 - Click **Add** in the Administrators Properties window.
 - Select the user you want to add to the Administrators group and click **Add**.
 - Click **OK** when you are finished.

How to Give a User Account GuavaSupervisor-Level Access

- 1 Right-click on the GuavaSupervisor group and select **Properties**.
- 2 Click **Add** in the GuavaSupervisor Properties window.
The Select Users window appears.

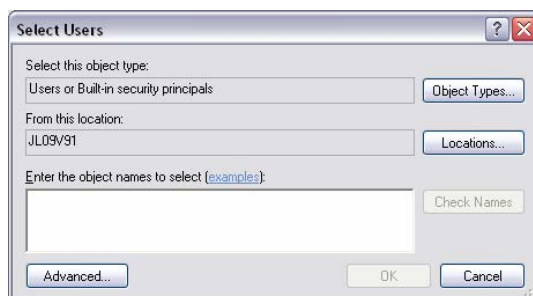

- 3 Enter the user login name for the supervisor and click **OK**.
- 4 Repeat these steps to add additional supervisors.

How to Give a User Account GuavaOperator-Level Access

- 1 Right-click on the GuavaOperator group and select **Properties**.
- 2 Click **Add** in the GuavaOperator Properties window. The Select Users window appears.

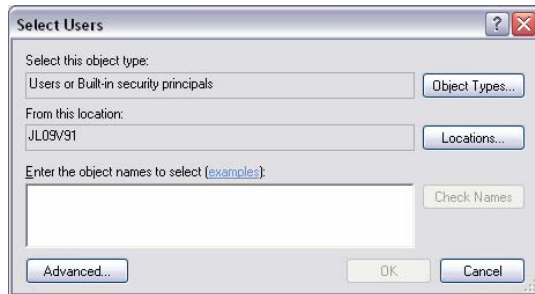

- 3 Enter the user login name for the operator and click **OK**.
- 4 Repeat these steps to add additional operators.
- 5 Reboot the system when finished. Click the **Start** button, click **Turn Off Computer**, click **Restart**.

Information For Network/IT Administrators

- User accounts which function as administrators for guava[®] Access Control do not need to have Windows Administrator privileges, they only need full control of the AccessRights folder within the guavaSoft[™] folder hierarchy.
- The guavaSettings folder described in “First-Time Setup After Installation” does not need to be in C: drive. It can be located anywhere as long as all users can access it. Although the setup procedures above do not detail how to do this, the Operator-level accounts do not need access to the guavaSettings folder, since they cannot create Settings files. Therefore, you could obtain greater security by arranging that the GuavaOperator Group has only Read access to the guavaSettings folder.
- All guavaSoft[™] software users need Read/Write/Modify access to the Log folder when running the easyCheck[™] Procedure, since this assay updates the GuavaCheckLog.

Administration Configuration

Administrators can configure or customize certain software features for supervisors and/or operators.

You must be logged on as an administrator to gain access to the Setup button on the guavaSoft[™] software main menu.

- 1 Click **Setup** from the main menu.

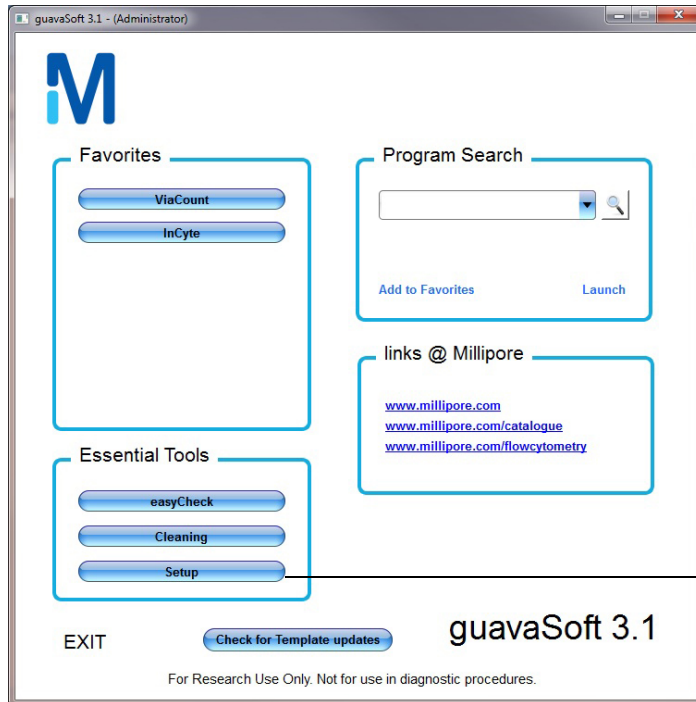

Available to administrators who log onto the system.

The Customize guavaSoft screen appears.

- 2 Select **Configure** under Access Rights.

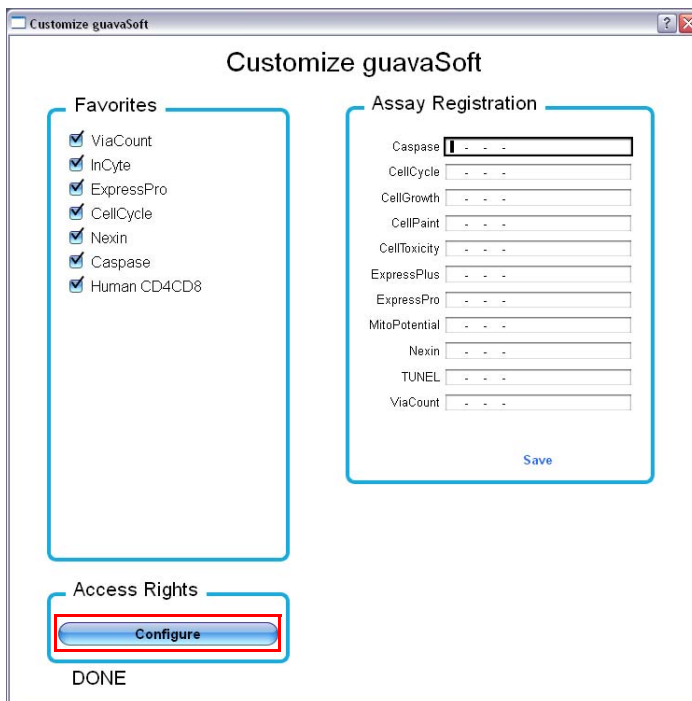

- 3 Click the check boxes for the features you wish to allow for supervisors and/or operators.

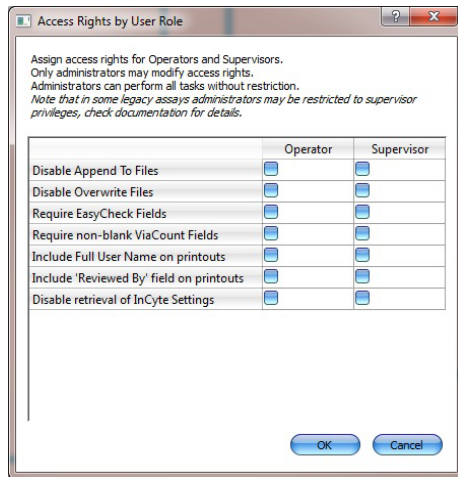

The following table describes each feature.

Feature	Description
Disable Append to File	If selected, will not allow user to append to an existing FCS 3.0 file. Users may overwrite the existing file or create a new file. This applies to a data file when you click New Data Set (or Start New Data Session File for InCyte™) at the start of a session. If overwriting is disabled (see below), you will be appending to a <i>copy</i> of the existing file since you cannot overwrite it. If overwriting is allowed, you will be appending to the end of the existing file.
Disable Overwrite File	If selected, will not allow users to overwrite an existing FCS 3.0 file. Users may append to the existing file or create a new file. This applies to a data file when you click New Data Set (or Start New Data Session File for InCyte™) at the start of a session, as well as to a data file when you make changes during analysis.
Require easyCheck Fields	If selected, the user must enter values for the Bead Lot #, Bead Expiration Date, and Expected Particles/mL before starting every easyCheck™ run. If this option is not selected, the information will default to the last information entered.
Require non-blank ViaCount Fields	If selected, the user must enter values for the Reagent Lot # and Reagent Expiration Date before a ViaCount Assay can be started. If this option is not selected, the reagent information is not required.

Feature	Description
Include Full User Name on Printouts	If selected, the user's full name is included on all printouts generated by that user. This information is taken from the "Full Name" field in the user's Windows XP account record.
Include "Reviewed By Field" on Printouts	If selected, places a <i>Reviewed by:</i> _____ field on all printouts generated by the user.
Disable retrieval of InCyte Settings	If selected, users cannot adjust instrument settings or retrieve InCyte™ Methods, instrument settings, and compensation settings from individual Method or instrument settings files. Methods, instrument settings, and compensation settings can only be retrieved from a single FCS file.

- 4 Click **OK** to save the settings.

Appendix B

Glossary

acquisition	The electronic and software function of collecting various types of information from a cell sample.
Analysed Group	An FCS file created in InCyte™ software. It contains the sample data and the Analysis Method. When data is acquired in InCyte™, the software will automatically pair the data set and Method for analysis. If data were acquired in any other guavaSoft™ module, you will need to pair the data with a new or existing Method during analysis to form the Analysed Group.
analysis	The software function of numerically and graphically manipulating data to identify and separate cell populations for the purpose of calculating relevant statistical information.
antibodies	A class of proteins secreted by sensitized B lymphocytes following contact with an antigen. Also referred to as immunoglobulins. Monoclonal antibodies, derived from a unique secreting clone of the parent B cell, are characterized by their highly specific antigen binding capabilities.
area	The area under the electronic pulse. The area measurement provides a more accurate assessment of total signal fluorescence.
caspases	CysteinyI-directed aspartate-specific proteases. A family of enzymes that initiate the apoptotic cascade, carry out cellular breakdown, and process cytokines.

coefficient of variation (%CV)	The ratio of the standard deviation to the mean, expressed as a percent. It is calculated using the formula: $\%CV = \frac{SD}{\bar{X}} \times 100$
compensation	A process of reducing the unwanted fluorescence signal of one fluorochrome overlapping into the range of wavelengths of another fluorochrome.
data set	A series of samples included within one file for a selected assay. An FCS file and a spreadsheet file are saved for each data set.
depolarized cells	Cells in which the mitochondrial membrane potential has collapsed. Because of this loss of negative potential, the JC-1 dye no longer accumulates in the mitochondria, causing cells to fluoresce mostly green.
detector	A device used to measure light intensity. The fluorescence detectors are photomultiplier tubes (PM1, PM2, and PM3) and the FSC detector is a photodiode. Both output a current that is proportional to the intensity of incident light.
dot plot	A graphical representation of two-parameter data. Each axis of the plot displays values for one parameter. A dot represents the values for a cell or particle.
FBS	Fetal bovine serum. A cell-free extraction of blood obtained from fetal calves used to supplement growth media in tissue culture.
FCS file	Flow Cytometry Standard file. A data file containing the results for an individual sample as well as all acquisition information at the time of data collection. FCS files are defined by the Data Files Standards Committee of the Society for Analytical Cytology. <i>Cytometry</i> . 1990;11:323–332.
flow cell	An optical assembly within the guava easyCyte™ System. The flow cell consists of a metal shuttle holding a glass capillary with a tiny chamber where the laser beam illuminates the sample stream and cellular measurements occur.

fluorescence	The phenomenon of light emission that occurs when a fluorochrome's excited electrons drop to a lower energy level.
fluorochrome	A fluorescent dye used as a detection reagent in cell analysis applications. A molecule capable of absorbing light at a certain wavelength, then emitting light at a longer wavelength (fluorescence) as it releases energy. For a list of all fluorochromes compatible with the easyCyte™ System, see "Fluorochromes" on page 4 of the Specifications section.
FSC	Forward scatter. Light scattered as a particle passes in front of the laser beam. Forward scattered light is used as an indicator of relative particle size and incorporates both the particle's cross-sectional dimension and refractive index.
gate	A graphical boundary that defines a subset of data. Gates may be set on a single-parameter histogram or a two-parameter dot plot.
helper/inducer T cells	T cells that promote the immune response by releasing soluble helper factors such as interleukin 2 and interleukin 4.
histogram	A graphical representation of single-parameter data. The horizontal axis of the graph represents the increasing signal intensity of the parameter and the vertical axis represents the number of events (cells).
isotype control	An antibody of the same immunoglobulin class and fluorescent capacity as the test reagent, but having no specificity for the target antigen or other antigens present on the test cells. The isotype control is used to estimate nonspecific binding of the test reagent.
laser	Light amplification by stimulated emission of radiation. A light source that is highly directional, monochromatic, coherent, and bright. The emitted light is in one or more narrow spectral bands, and is concentrated in an intense, narrow beam.
marker	A boundary or set of boundaries used to segregate data into subsets for statistical analysis. Set a marker on a histogram to obtain statistics on a certain region. Set quadrant markers on a dot plot to obtain statistics on data within four quadrants.

mean fluorescence	The average of the fluorescence intensities of each event acquired within a given set of events.
median	The axis value for the event that falls in the middle of the distribution.
Method	The part of an InCyte™ FCS file that contains all the analysis components (gates, regions, markers, plots, parameters, and statistical setup). Methods can be part of the FCS file and can also be saved to a separate file (.gsy). Data files acquired using a program other than InCyte™ will not have Methods associated with them, therefore you must use a new or existing Method before you can analyze the file using InCyte™.
monocytes	Immature macrophages found in the blood.
NK cells	Natural killer cells. Non-T, non-B lymphocytes found in normal individuals and capable of killing some tumor cells and some virus-infected cells.
offset	A baseline detector setting for an individual assay to ensure that the cells are being detected.
parameter	A specific cell property that is measured as the cell passes in front of the laser beam. Each parameter is the output from a photomultiplier (which measures fluorescence) or a photodiode (which measures forward scatter).
PMNs	Polymorphonuclear cells. Myeloid cells that are derived from the bone marrow. These cells possess a lobulated, irregular nucleus and cytoplasm that is filled with granules. PMNs consist of neutrophils, eosinophils, and basophils.
PMT	Photomultiplier tube. A device used for measuring light intensity.
polarized cells	Cells which exhibit a normal mitochondrial membrane potential, and hence when exposed to the JC-1 dye, fluoresce mostly orange.

population	A group of cells that express similar values within one or more parameters. For example, cells that are positive for a particular antibody appear in the same location within a histogram or dot plot.
SR-VAD-FMK	Sulforhodamine-valyl-alanyl-aspartyl-fluoromethylketone. A cell-permeable, noncytotoxic caspase inhibitor that covalently binds to multiple caspases that have been activated during apoptosis.
SSC	Side scatter. Light scattered as a particle passes in front of the laser beam. Side scattered light is measured at approximately 90° from the incident laser beam. Side scattered light is used as an indicator of a particle's relative internal granularity.
suppressor/cytotoxic T cells	T cells that suppress the response of other cells to antigen, or kill other cells in an antigen-specific manner.
T cells	Lymphocytes that have undergone a period of processing in the thymus and are responsible for mediating the cell-mediated immune response.
threshold	The minimum level of discrimination to electronically eliminate unwanted signal. A threshold setting allows you to specify events you wish to acquire based on signal intensity of the event. Anything below the threshold is not acquired.
width	The width of the electronic pulse. The width measurement helps you discriminate doublets from singlets.





Appendix C

Ordering Information

For ordering information contact the nearest EMD Millipore office by calling 1 800 645-5476, or visiting us on our website at www.millipore.com/offices.

EMD Millipore and its distribution network will provide guava[®] products to all sectors of life science research in certain countries outside North America and Europe.

Instrument Components

Parts	Catalog Number
guava easyCyte™ 12 System (software not included)	0500-5012
guava easyCyte™ 8 System (software not included)	0500-5008
guava easyCyte™ 6-2L System (software not included)	0500-5007
guava easyCyte™ 5 System (software not included)	0500-5005
laptop computer	0110-3670
sample tube holder, titer tubes	0100-0060
sample tube holder, 1.5-mL microcentrifuge tubes	0100-2180
cleaning solution vial assembly (small, metal tubing connector) 	0110-3030
(large, plastic tubing connector) 	0110-8125
waste vial assembly (small, metal tubing connector) 	0110-3020
(large, plastic tubing connector) 	0110-8120
flow cell assembly	0500-2270
flow cell tightening tool	6000-2410
flow cell removal tool (tweezer model)	6000-3020
syringe assembly cleaning tool	0110-0210
<i>guava easyCyte™ System User Guide</i> text	0110-8493
instrument shipping box	0110-2640

Software

guava easyCyte™ System Software Modules	Catalog Number
guava [®] ExpressPro Software Module (required for 6-color operation)	0500-4125
guava InCyte™ Software Module	0500-4120
guavaSuite Software Modules for the guava easyCyte 12 System	0500-4130

Essential Tools

Kit	Catalog Number
guava easyCheck™ Kit (50 tests)	4500-0025
Guava® ICF (Instrument Cleaning Fluid) [100 mL]	4200-0140

Reagent Kits

Cell Health	Catalog Number
<u>ViaCount Assay Kits</u>	
Guava® ViaCount Reagent (100 tests)	4000-0040
Guava® ViaCount Reagent (600 tests)	4000-0041
Guava® ViaCount Flex Reagent (100 tests)	4500-0110
Guava® ViaCount Flex Reagent (500 tests)	4700-0060
CDR (Cell Dispersal Reagent) [100 tests]	4700-0050
<u>Cell Cycle Kits</u>	
FlowCelect® Bivariate Cell Cycle Kit for DNA Replication Analysis (25 tests)	FCCH025102
FlowCelect® Bivariate Cell Cycle Kit for G2/M Analysis (25 tests)	FCCH025103
Guava® Cell Cycle Reagent (100 tests)	4500-0220
<u>DNA Damage Kits</u>	
FlowCelect® Multi-Color DNA Damage Response Kit (25 tests)	FCCH025104
FlowCelect® DNA Damage Histone H2A.X Dual Detection Kit (25 tests)	FCCS025153
FlowCelect® Cell Cycle Checkpoint H2A.X DNA Damage Kit (25 tests)	FCCH025142
FlowCelect® Cell Cycle Checkpoint ATM DNA Damage Kit (25 tests)	FCCH025143
FlowCelect® Histone H2A.X Phosphorylation Assay Kit	FCCS100182
<u>MitoHealth Kits</u>	
FlowCelect® MitoPotential Red Kit (100 tests)	FCCH100105
FlowCelect® MitoDamage Kit (100 tests)	FCCH100106
FlowCelect® MitoLive Kit (100 tests)	FCCH100107
FlowCelect® MitoStress Kit (100 tests)	FCCH100109
FlowCelect® Cytochrome c Kit (100 tests)	FCCH100110
FlowCelect® Oxidative Stress Characterization Kit (25 tests)	FCCH025111
guava® MitoPotential Kit (100 tests)	4500-0250
<u>Apoptosis Kits</u>	
<i>Early Apoptosis Kits</i>	
FlowCelect® Annexin Red Kit (100 tests)	FCCH100108
guava® Nexin Reagent (100 tests)	4500-0450
guava® Nexin Reagent (500 tests)	4500-0455
<i>Mid Apoptosis Kits</i>	
guava® MultiCaspase SR Kit (100 tests)	4500-0500
guava® Caspase 9 SR Kit (100 tests)	4500-0520
guava® MultiCaspase FAM Kit (100 tests)	4500-0530
guava® Caspase 3/7 FAM Kit (100 tests)	4500-0540
guava® Caspase 8 FAM Kit (100 tests)	4500-0550
guava® Caspase 9 FAM Kit (100 tests)	4500-0560
guava® MultiCaspase SR and Caspase 3/7 FAM Kit (100 tests)	4500-0570
guava® MultiCaspase SR and Caspase 8 FAM Kit (100 tests)	4500-0580

Cell Health	Catalog Number
guava [®] MultiCaspase SR and Caspase 9 FAM Kit (100 tests)	4500-0590
guava [®] Caspase 9 SR and Caspase 3/7 FAM Kit (100 tests)	4500-0630
guava [®] Caspase 9 SR and Caspase 8 FAM Kit (100 tests)	4500-0640
guava [®] Caspase 9 SR and MultiCaspase FAM Kit (100 tests)	4500-0650
<i>Late Apoptosis Kits</i>	
guava [®] TUNEL Kit (100 tests)	4500-0121
<i>Apoptosis Signaling Kits</i>	
FlowCelect [®] Bcl-2 Activation Dual Detection Kit (25 tests)	FCCS025108
<u>Autophagy</u>	
FlowCelect [®] GFP-LC3 Reporter Autophagy Assay Kit (CHO) [25 tests]	FCCH100170
FlowCelect [®] Autophagy Reagent Pack (25 tests)	FCCF200097
FlowCelect [®] GFP-LC3 Reporter Autophagy Assay Kit (U20S) [25 tests]	FCCH100181
FlowCelect [®] RFP-LC3 Reporter Autophagy Assay Kit (25 tests)	FCCH100183
FlowCelect [®] Autophagy LC3 Antibody-based Assay Kit (100 tests)	FCCH100171
<hr/>	
Immunology	Catalog Number
<u>Intracellular Cytokine Kits</u>	
<i>Helper T Cell Kits – Mouse</i>	
FlowCelect [®] Mouse Th1 Intracellular Cytokine Kit (25 tests)	FCIM025123
FlowCelect [®] Mouse Th2 Intracellular Cytokine Kit (25 tests)	FCIM025124
FlowCelect [®] Mouse Th17 Intracellular Cytokine Kit (25 tests)	FCIM025125
FlowCelect [®] Mouse Th1/Th2 Intracellular Cytokine Kit (25 tests)	FCIM025137
FlowCelect [®] Mouse Th1/Th17 Intracellular Cytokine Kit (25 tests)	FCIM025138
FlowCelect [®] Mouse Th1 Differentiation Tool Kit (25 tests)	FCIM025161
FlowCelect [®] Mouse Th2 Differentiation Tool Kit (25 tests)	FCIM025162
FlowCelect [®] Mouse Th17 Differentiation Tool Kit (25 tests)	FCIM025163
FlowCelect [®] Mouse Treg Differentiation Tool Kit (25 tests)	FCIM025166
<i>T-Cell Kits – Human</i>	
FlowCelect [®] Human FOXP3 Treg Characterization Kit (25 tests)	FCIM025118
FlowCelect [®] Human CD4/CD8 T Cell Kit (100 tests)	FCIM100158
<i>T-Cell Kits – Mouse</i>	
FlowCelect [®] Mouse FOXP3 Treg Identification Kit (25 tests)	FCIM025126
FlowCelect [®] Mouse Viable Treg Characterization Kit (25 tests)	FCIM025168
<i>B-Cell Identification Kits – Human</i>	
FlowCelect [®] Human Memory B Cell Identification Kit (25 tests)	FCIM025159
FlowCelect [®] Human B Cell FAS Kit (100 tests)	FCCH100137
<i>B-Cell Identification Kits – Mouse</i>	
FlowCelect [®] Mouse Breg Identification Kit (25 tests)	FCIM025154
<i>Immune Cell Health - Human</i>	
FlowCelect [®] Human T Cell Apoptosis Kit (100 tests)	FCCH100138
FlowCelect [®] T Cell MitoDamage Kit (100 tests)	FCCH100139
FlowCelect [®] T Cell Activation Kit (100 tests)	FCCH100141
FlowCelect [®] Human CD8 T Cell FAS Kit (100 tests)	FCCH100140
FlowCelect [®] Human CD4 T Cell FAS Kit (100 tests)	FCCH100154
FlowCelect [®] Human T Cell Caspase 3/7 Kit (100 tests)	FCCH100157

Immunology	Catalog Number
FlowCelect [®] Human T Cell Caspase 8 Kit (100 tests)	FCCH100155
FlowCelect [®] Human T Cell Caspase 9 Kit (100 tests)	FCCH100156
guava [®] CellToxicity Kit (100 tests)	4500-0230
guava [®] CellGrowth Kit (200 tests)	4500-0270
Cell Signalling	Catalog Number
<u>MAPK Pathway</u>	
FlowCelect [®] PI3K/MAPK Dual Pathway Activation and Cancer Marker Detection Kit (25 tests)	FCCS025100
FlowCelect [®] EGFR/MAPK Pathway Activation Detection Kit (25 tests)	FCCS025101
FlowCelect [®] MAPK Activation Dual Detection Kit (25 tests)	FCCS025106
FlowCelect [®] p38 Stress Pathway Activation Detection Kit (25 tests)	FCCS025132
<u>EGFR Pathway</u>	
FlowCelect [®] EGFR/MAPK Pathway Activation Detection Kit (25 tests)	FCCS025101
FlowCelect [®] EGFR/RTK Activation Dual Detection Kit (25 tests)	FCCS025107
<u>PI3K/Akt/m-TOR Pathway</u>	
FlowCelect [®] PI3K/MAPK Dual Pathway Activation and Cancer Marker Detection Kit (25 tests)	FCCS025100
FlowCelect [®] PI3K Activation Dual Detection Kit (25 tests)	FCCS025105
FlowCelect [®] PI3K-mTOR Signaling Cascade Kit (25 tests)	FCCS025210
<u>Jak/STAT Pathway</u>	
FlowCelect [®] EGFR/STAT3 Pathway Activation Detection Kit (25 tests)	FCCS025111
FlowCelect [®] Multi-STAT Activation Profiling Kit (25 tests)	FCCS025550
FlowCelect [®] STAT1 Activation Dual Detection Kit (25 tests)	FCCS025142
FlowCelect [®] STAT3 Activation Dual Detection Kit (25 tests)	FCCS025143
<u>Multiple Pathway</u>	
FlowCelect [®] PLC-gamma 1 Activation Dual Detection Kit (25 tests)	FCCS025145
FlowCelect [®] Src Activation Dual Detection Kit (25 tests)	FCCS025154
<u>Apoptosis Signaling Pathway</u>	
FlowCelect [®] Bcl-2 Activation Dual Detection Kit (25 tests)	FCCS025108
<u>Chemokine Receptor Kits</u>	
FlowCelect [®] Chemokine Receptor CCR1 Surface Expression Identification and Quantification Kit (25 tests)	FCCR100410
FlowCelect [®] Chemokine Receptor CXCR6 Surface Expression Identification and Quantification Kit (25 tests)	FCXR600424
<u>Stem Cell Kits</u>	
<i>Human</i>	
FlowCelect [®] Human NK Cell Characterization Kit (25 tests)	FCIM025164
<i>Rodent</i>	
FlowCelect [®] Rodent NSC Characterization Kit (Neural) [25 tests]	FCRNC25112

Service Plans

Service Total Plans	Catalog Number
guava easyCyte™ 5 Service Total 1-yr plan (at time of purchase)	0500-5300
guava easyCyte™ 5 Service Total 1-yr plan (after purchase)	0500-5305
guava easyCyte™ 5 Service Total 2-yr plan	0500-5310
guava easyCyte™ 6-2L Service Total 1-yr plan (at time of purchase)	0500-5330
guava easyCyte™ 6-2L Service Total 1-yr plan (after purchase)	0500-5335
guava easyCyte™ 6-2L Service Total 2-yr plan	0500-5340
guava easyCyte™ 8 Service Total 1-yr plan (at time of purchase)	0500-5870
guava easyCyte™ 8 Service Total 1-yr plan (after purchase)	0500-5875
guava easyCyte™ 8 Service Total 2-yr plan	0500-5880
guava easyCyte™ 12 Service Total 1-yr plan (at time of purchase)	0500-6870
guava easyCyte™ 12 Service Total 1-yr plan (after purchase)	0500-6875
guava easyCyte™ 12 Service Total 2-yr plan	0500-6880

Preventative Maintenance Plans	Catalog Number
guava easyCyte™ 5 Preventative Maintenance 1-yr plan (at time of purchase)	0500-5285
guava easyCyte™ 5 Preventative Maintenance 1-yr plan (after purchase)	0500-5290
guava easyCyte™ 5 Preventative Maintenance 2-yr Plan	0500-5295
guava easyCyte™ 6-2L Preventative Maintenance 1-yr plan (at time of purchase)	0500-5315
guava easyCyte™ 6-2L Preventative Maintenance 1-yr plan (after purchase)	0500-5320
guava easyCyte™ 6-2L Preventative Maintenance 2-yr Plan	0500-5325
guava easyCyte™ 8 Preventative Maintenance 1-yr plan (at time of purchase)	0500-5270
guava easyCyte™ 8 Preventative Maintenance 1-yr plan (after purchase)	0500-5275
guava easyCyte™ 8 Preventative Maintenance 2-yr Plan	0500-5280
guava easyCyte™ 12 Preventative Maintenance 1-yr plan (at time of purchase)	0500-6370
guava easyCyte™ 12 Preventative Maintenance 1-yr plan (after purchase)	0500-6375
guava easyCyte™ 12 Preventative Maintenance 2-yr Plan	0500-6380

On-Site Instrument Training and Application Support	Part Number
guava easyCyte™ Installation and Basic Training (half day)	0500-1690
guava easyCyte™ Installation and Advanced Training (full day)	0500-1680

Installation Qualification/Operation Qualification (IQ/OQ)	Part Number
guava easyCyte™ IQ/OQ (customer performed)	8000-1995
guava easyCyte™ IQ/OQ (EMD Millipore performed)	8000-1996

Additional Supplies

The following materials can be ordered directly from the manufacturer.

Tubes	Catalog Number
Microcentrifuge tubes, 1.5-mL, conical bottom, screw cap	
• VWR International–clear tubes	16466-030
• VWR International–screw caps	89004-346
• VWR International–tubes with caps	60872-324
• Fisher Scientific–clear tubes	02-681-339
Microtiter tubes, 1.2-mL conical bottom, no caps	
• E & K Scientific–tubes	604508-RC
• VWR International–tubes	46300-494

Specifications

guava easyCyte™ System

Operating Environment

temperature:	16°–30°C (60°–86°F)
humidity:	10–90% relative humidity (non-condensing)
power:	100–240 VAC, 50/60 Hz, 120W
fuse rating:	USA and Japan (110 V): 2.5 A, 250 V Time-lag Europe: (220-240 V): 1.6 A, 250 V Time-lag (x2)

Instrument size:

height:	9.1 in (23.1 cm)
width:	17.7 in (45 cm)
depth:	17.5 in (44.4 cm)

Instrument weight:

35 lb (15.9 kg)

laptop size:

height:	11.5 in (29.2 cm) when open
width:	14.2 in (36.1 cm)
depth:	10.4 in (26.4 cm)

laptop weight:

8 lb (3.6 kg)

Optics

lasers:	violet laser (405 nm), 100 mW blue laser (488 nm), 150 mW red laser (642 nm), 100 mW
forward scatter detector:	photodiode
side scatter detector:	photodiode
fluorescence detectors:	See “easyCyte Lasers and Fluorescent Filters” on the following page.

Signal Processing

parameter dynamic range:	3.5 decades (except as noted below): 4.0 decades (guava® ExpressPro, and Caspase software module) 5.0 decades (guava InCyte™ software module)
pulse processing:	digital signal processing
time:	every particle time stamped

Performance

counting accuracy:	±10%
counting precision:	≤10% CV

Fluidics

flow cell dimension:	standard square capillary with ID of 100 µm
pump:	positive displacement
sample flow rate:	7 µL/min to 36 µL/min (7 µL/min to 72 µL/min for guava InCyte™, ExpressPro, and Caspase modules)
cleaning and waste vials:	15-mL glass vials with screw tops
waste generation:	typically <40 mL in 8 hours of continuous use
dead volume:	50 µL (for 1.5-mL tubes)
sample concentration:	final particle concentration of 10 ⁴ to 10 ⁶ particles/mL for accurate results
sample requirement:	as few as 2,000 cells/test; typically 25,000–100,000 cells/test depending on the assay

Data Management

computer:	Dell™ laptop running Windows 7 Ultimate (32-bit only), and including Microsoft Excel. Minimum configuration: Intel Core i5-3210M processor (2.5 GHz, 3M cache); 4 GB, DDR3-1600 MHz SDRAM; 320 GB hard drive; 2 USB ports
data file structure:	Output data file formats: <ul style="list-style-type: none">• binary data storage in Flow Cytometry Standard (FCS) 3.0 format• spreadsheet results file in comma-separated value (CSV) format• optional export of binary data in FCS 2.0 or 3.0 format• optional CSV list-mode data

easyCyte Lasers and Fluorescent Filters

The following table lists the laser and power for each of the easyCyte™ instruments, and the filters used for each parameter.

	Filter	Instrument				Legacy name	New Name
		5 & 5HT	6-2L & 6-2LHT	8 & 8HT	12 & 12HT		
Laser		488 nm (blue)	488 nm (blue)	488 nm (blue)	488 nm (blue)		
Power		50 mW	50 mW	150 mW	150 mW		
FSC	N/A	X	X	X	X	FSC	FSC
SSC	488/16	X	X	X	X	SSC	SSC
Green-B	525/30	X	X	X	X	GRN	GRN-B
Yellow-B	583/26	X	X	X	X	YLW	YEL-B
Red-B	695/50	X	X	X	X	RED	RED-B
NIR-B	785/70	N/A	N/A	X	X	NIR	NIR-B
Laser		N/A	N/A	N/A	405 nm (violet)		
Power					100 mW		
Blue-V	450/45				X	N/A	BLU-V
Green-V	525/30				X		GRN-V
Yellow-V	583/26				X		YEL-V
Red-V	695/50				X		RED-V
Laser		N/A	642 nm (Red)	642 nm (Red)	642 nm (Red)		
Power			100 mW	100 mW	100 mW		
Red-R	662/15		X	X	X	RED2	RED-R
NIR-R	785/70		N/A	X	X	NIR2	NIR-R

Fluorochromes

The following tables, list all fluorochromes that can be used with the easyCyte™ System, the laser that excites the dye, and the parameter/detector that detects the emitted signal.

Blue (448/50 nm)	Green (525/30 nm)	Yellow (583/26 nm)	Red (661/15 nm)	Red (695/50 nm)	NIR (785/70 nm)
DAPI	AlexaFluor™ 430	Pacific Orange	Alexa Fluor® 647	eFluor 650	PE-Alexa Fluor® 750
Hoescht 33258	Pacific Green	Brilliant Violet	APC	Brilliant Violet	Propidium Iodide
Alexa Fluor® 405	Brilliant Violet™	Odot 565	CD647	Odot 705	PE-Cy™7
Marnia Blue	Odot 525	Odot 585	Cy™5	7-AAD	APC-Cy™7
Pacific Blue™	Odot 545	Alexa 555	Odot 655	Propidium Iodide	APC-Alexa Fluor® 750
Live/Dead Violet	FITC	Alexa 568	DRAQ5	PE-Alexa Fluor® 647	
DyLight 405	GFP	CF™555	Ethidium bromide	PE-Alexa Fluor® 700	
eFluor 450	AlexaFluor™ 488	CD568	Ethidium homodimer	PE-Cy™5	
Zombie Aqua™	CF™488	PE-B, PE-R	SYTOX® Red	PE-Cy™5.5	
Brilliant Violet™	Cy™2	PE-Texas Red®	TO-PRO™-3	PE-Texas Red®	
	FAM	Odot 565	TOTO-3	PerCP	
	Rhodamine 110	Acridine Orange	DiIC1(5)	PerCP-Cy™5.5	
	Odot 525	dsRED	MitoSense Red	Odot 705	
	Acridine Orange	Ethidium bromide	BODIPY™ 650/665	DRAQ5	
	EGFP	Ethidium homodimer		Ethidium bromide	
	EYFP	SYBR Gold		Ethidium homodimer	
	Thiazole Orange	SYBR Green		LDS-751	
	SYBR Gold	SYTOX® Orange		Nile Red	
	SYBR Green	TO-PRO™-1			
	SYTO® BC	JC-1			
	SYTOX® Green	TMRE			
	YO-PRO™-1	TRMR			
	YO-YO™-1	CFSE			
	DiOC6(3)	Nile Red			
	JC-1				
	Rhodamine 123				
	BODIPY™-FL				
	Calcien				
	CFSE				
	Oregon Green™				
			405-nm laser	488-nm laser	642-nm laser

Compliance

The guava easyCyte™ System contains three lasers:

- a Class IIIb laser operating at 405 nm in CW mode
- a Class IIIb laser operating at 488 nm in CW mode
- a Class IIIb laser operating at 642 nm in CW mode

Light shields within the instrument enclose the path of laser radiation. Additionally, the instrument enclosure provides secondary protection from any laser radiation.

This product complies with:

- CFR (Code of Federal Regulations) Chapter 1, Subchapter J and installation (overvoltage) category II
- Class 1 limits for exposure to laser radiation set by the Center for Devices and Radiologic Health (CDRH)
- EN 60825-1:2007, EN 61010-1:2010, and EN 61326-1:2013
- CAN/CSA-C22.2 No. 61010-1-04, UL Std. No 61010-1 (2nd Edition)

Symbols



Attention, consult accompanying documents.



Affixed in accordance with European Council Directive 73/23/EEC



Danger, laser radiation



In accordance with Canadian Standards Association



Separate collection of waste at end of life as required by European Directives. Dispose of in accordance with the applicable country regulation.



Dangerous voltage



Power on



Power off

Notice to Purchaser: Limited Use License

Use of this product is covered by one or more of the following US patents and corresponding patent claims outside the US: (5,798,222; 6,403,378; 6,710,871; 6,816,257; 7,320,775; 7,410,809; 8,184,271 and 7,847,923). The purchase of this product includes a limited, non-transferable immunity from suit under the foregoing patent claims for using this product by the purchaser for its own internal research. No right under any other patent claim, no right to perform any patented method, and no right to perform commercial services of any kind, including, without limitation, reporting the results of purchaser's activities with use of the product for a fee or other commercial consideration, is conveyed by express implication, or by estoppel. This product is intended for research use only. Diagnostic uses require a separate use license from EMD Millipore. Further information on commercial licenses may be obtained by contacting the Director of Licensing, as listed on EMD Millipore's website:

http://www.emdmillipore.com/proprietary-technologies-available-for-licensing/c_bhCsHfETIxYAAAE1gKU2Vc2d?back=true

The Product has not been tested by EMD Millipore for safety and efficacy in food, drug, device, cosmetic, commercial or any other use.

The Product is not a medical device for the purposes of the Medical Devices Regulations 2002 or any other Regulations derived from Directive 98/79/EC ("Medical Devices"), and the Product is not in any circumstances to be sold or distributed for use as a Medical Device.

EMD MILLIPORE AND ITS AFFILIATES shall not, no matter how such liability may be purported to arise, except in the case of personal injury or death arising directly out of the gross negligence, recklessness or willful misconduct of EMD MILLIPORE OR ITS AFFILIATES, be liable to the Purchaser, or purchaser's affiliates or purchaser's customers, employees or students, for any loss or damage (including consequential damage or economic loss or loss of profits) arising out of, or in connection with, the sale or use of the Product.

TO THE FULLEST EXTENT PERMITTED BY APPLICABLE LAW, IN NO EVENT SHALL EMD MILLIPORE'S LIABILITY ARISING OUT OF THE MANUFACTURE, SALE, SUPPLY, USE OR DISPOSITION OF THE PRODUCT, WHETHER BASED ON WARRANTY, CONTRACT, TORT OR OTHERWISE, EXCEED THE ACTUAL PRICE PAID BY PURCHASER FOR THE PURCHASED PRODUCT.

Warranty

EMD Millipore Corporation (“Millipore”) warrants its products will meet their applicable published specifications when used in accordance with their applicable instructions for a period of one year from shipment of the products. **MILLIPORE MAKES NO OTHER WARRANTY, EXPRESSED OR IMPLIED. THERE IS NO WARRANTY OF MERCHANTABILITY OR FITNESS FOR A PARTICULAR PURPOSE.** The warranty provided herein and the data, specifications, and descriptions of Millipore products appearing in Millipore's published catalogues and product literature may not be altered except by express written agreement signed by an officer of Millipore. Representations, oral or written, which are inconsistent with this warranty or such publications are not authorized, and if given, should not be relied upon.

In the event of a breach of the foregoing warranty, Millipore's sole obligation shall be to repair or replace, at its option, the applicable product or part thereof, provided the customer notifies Millipore promptly of any such breach. If after exercising reasonable efforts, Millipore is unable to repair or replace the product or part, then Millipore shall refund to the Company all monies paid for such applicable Product. **MILLIPORE SHALL NOT BE LIABLE FOR CONSEQUENTIAL, INCIDENTAL, SPECIAL, OR ANY OTHER DAMAGES RESULTING FROM ECONOMIC LOSS OR PROPERTY DAMAGE SUSTAINED BY ANY COMPANY CUSTOMER FROM THE USE OF ITS PRODUCTS.**

© 2014 EMD Millipore Corporation. All rights reserved. No part of these works may be reproduced in any form without permission in writing.

Unless otherwise stated in our catalog or other company documentation accompanying the product(s), our products are intended for research use only and are not to be used for any other purpose, which includes but is not limited to, unauthorized commercial uses, in vitro diagnostic uses, ex vivo or in vivo therapeutic uses, or any type of consumption or application to humans or animals.

Index

A

- Abort button 1-16
- Acquire Next Sample button 1-15
- Acquisition screen 1-14 to 1-17
- adjusting settings
 - InCyte assay 4-8 to 4-11
- analysis
 - InCyte 4-13 to 4-32
- Analysis screen 1-18 to 1-19
- area, pulse measurement
 - InCyte 4-9
- assays
 - Guava InCyte 4-6 to 4-19
- Autostart Acquisition feature 1-16

B

- Backflush button 1-16
- backflushing fluid system 1-7, 3-4
- backgating 4-24
- beads, easyCheck 2-3
- bleach solution
 - adding to waste vial 3-6
 - for backflushing 3-4
 - for cleaning 3-3
 - for Quick Clean 3-1
- buttons
 - Abort 1-16
 - Acquire Next Sample 1-15
 - acquisition 1-15
 - assay 1-9
 - Backflush 1-16
 - Cleaning 1-9
 - easyCheck 1-9
 - Exit 1-10
 - Next Step 1-15
 - Quick Clean 1-16
 - Save and Close Current Sample 1-15
 - Setup 1-9
 - Start Worklist 1-15
 - stop and close session 1-16
 - Stop Worklist 1-15

C

- cleaning
 - flow cell 3-6 to 3-9
 - Guava Clean 3-2 to 3-3

- outside of instrument 3-1
 - Quick Clean 3-1
 - solution 3-1, 3-3
- cleaning solution vial 1-7
 - filling 3-4
- clog 1-7, 3-4
- compensation
 - during adjust settings 4-10
 - post acquisition 4-35
 - semi-automated 4-36
- computer, internal
 - connecting to network 1-3
- contour plots
 - InCyte 4-3
- counting
 - beads, easyCheck 2-4
 - gate, InCyte 1-17, 4-11

D

- data analysis
 - InCyte 4-13 to 4-32
- deionized water
 - for Quick Clean 3-1
 - system shutdown 2-2, 3-3
- dilution factor
 - Guava InCyte 1-17

E

- easyCheck 2-3 to 2-4
 - beads 2-3
 - event log 2-6
 - exporting results 2-6
 - logging comments 2-6
 - reviewing previous results 2-5
 - trend graph 2-6, 2-7
 - troubleshooting 2-8
- events to acquire
 - InCyte assay 1-17
- exporting
 - easyCheck results to spreadsheet file 2-6
 - event log 1-22
 - InCyte results to spreadsheet file 4-33

F

- FCS 2.0 data file 4-33
- FCS 3.0 data file 1-20

- file name
 - data set 4-7
 - instrument settings 1-20

- files
 - appending 1-21
 - FCS 2.0 4-33
 - FCS 3.0 1-20
 - overwriting 1-21
 - settings 1-20, 1-22

- flash drive 1-7

- flow cell
 - backflushing 3-4
 - cleaning 3-6 to 3-9
 - replacing 3-10 to 3-11

- flow cytometry standard (FCS) file
 - exporting 4-33

- fluid system 1-7

- fuses, replacing 3-12

G

- gate
 - InCyte 4-22 to 4-25
- Guava Clean 3-2 to 3-3
- Guava EasyCyte 1-1, 1-6 to 1-7
 - cleaning 3-2 to 3-3
 - cleaning solution vial 3-4
 - flow cell 3-6, 3-10
 - fluid system 1-7
 - laser 1-7
 - loading samples 1-6
 - power conditioner 1-2
 - waste vial 1-7, 3-5

- Guava ICF 3-1, 3-3

- Guava InCyte
 - acquisition control panel 1-17
 - analysis methods 4-14
 - assay 4-6 to 4-19
 - changing parameter names 4-5
 - compensation 4-10
 - contour plots 4-3
 - creating groups 4-46
 - EC50 4-44
 - exporting results to spreadsheet file 4-33
 - gating 4-22 to 4-25
 - HeatMap 4-38
 - overlying histograms 4-49
 - post-acquisition compensation 4-35
 - printing current run stats 4-28
 - printing group stats 4-32
 - pulse area 4-9
 - pulse width 4-9
 - regions 4-19 to 4-22
 - setting statistical thresholds 4-43

- statistics 4-26 to 4-32
- troubleshooting 4-51
- unlocking 1-10
- workspace 4-5

- guavaSoft software 1-1
 - Acquisition screen 1-14 to 1-17
 - Analysis screen 1-18 to 1-19
 - main menu 1-8
 - overview 1-8 to 1-11
 - quitting 2-2
 - starting 2-1

H

- HeatMap 4-38

I

- InCyte assay 4-6 to 4-19
- installing the system 1-2 to 1-3
- instrument settings
 - adjusting 1-15
 - files 1-22
 - retrieving 1-15, 1-23
 - saving 1-16, 1-23
 - See also adjusting settings

L

- laser 1-7
- loading a sample 1-6
- loading samples 4-8

M

- minstac tubing 3-6

N

- Next Step button 1-15

O

- order information K-1 to K-5
- original volume
 - Guava InCyte 1-17
- overlying histograms 4-49

P

- power conditioner 1-2
- printer 1-3
- printing
 - easyCheck results 2-6
- printing results
 - InCyte 4-28, 4-32

Q

- quadrant markers

- InCyte 4-27, 4-27
- Quick Clean 3-1
- Quick Clean button 1-16
- quitting, guavaSoft 2-2

R

- replacing
 - flow cell 3-10 to 3-11
 - fuses 3-12
- retrieving instrument settings 1-23
- running
 - easyCheck 2-3 to 2-4
 - Guava Clean 3-2 to 3-3
 - Quick Clean 3-1

S

- sample ID
 - InCyte assay 1-17
 - when using Autostart Acquisition 1-16
- sample loader
 - changing tube holders 1-3
 - loading a sample 1-6
- sample number
 - for appended files 1-21
 - InCyte assay 1-17
- Save and Close Current Sample button 1-15
- saving instrument settings 1-23
- settings files 1-20, 1-22
- shutting down system 2-2
- Start Worklist button 1-15
- starting
 - guavaSoft software 2-1
 - system 2-1
- Stop Worklist button 1-15
- system
 - components 1-2
 - shutdown 2-2
 - startup 2-1

T

- threshold setting
 - InCyte assay 4-10
- troubleshooting
 - easyCheck 2-8
 - InCyte 4-51
- tubes supported 1-3
- tubing
 - minstac 3-6

U

- unlocking InCyte 1-10

W

- waste vial 1-7
 - emptying 3-5
- width, pulse measurement 4-9



For ordering information or technical support,
call toll-free in the USA and Canada,
Phone: +1 (800) 645-5476
Fax: +1 (951) 676-9209

For additional contact information, visit www.millipore.com

25801 Industrial Blvd.
Hayward, CA 94545-2991 USA

