



PR Series Balances
Instruction Manual

Balanzas Serie PR
Manual de Instrucciones

Balance de Série PR
Manuel d'instruction

PR Serie Waagen
Bedienungsanleitung

Bilance Serie PR
Manuale di Istruzioni

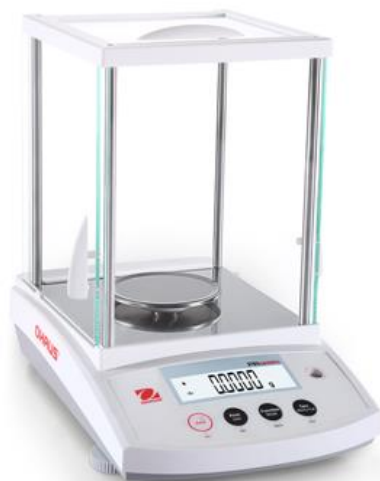

Table of Contents

1. INTRODUCTION	EN-3
1.1 Description	EN-3
1.2 Features	EN-3
1.3 Definition of Signal Warnings and Symbols	EN-3
1.4 Safety Precautions	EN-3
2. INSTALLATION	EN-4
2.1 Unpacking	EN-4
2.2 Select the Location	EN-4
2.3 Leveling	EN-4
2.4 Connecting Power and Acclimating the Balance	EN-4
2.5 Connecting the Interface	EN-5
2.6 Initial Calibration	EN-5
3. OPERATION	EN-6
3.1 Overview of Display, Home Screen	EN-6
3.2 Principal Functions and Main Menu	EN-7
3.3 Overview of Parts and Features – Draft Shield Mode	EN-7
3.4 Overview of Parts and Features – Non-Draft Shield Models	EN-7
4. APPLICATIONS	EN-8
4.1 Weighing	EN-8
4.2 Parts Counting	EN-8
4.3 Percent Weighing	EN-10
4.4 Additional Features	EN-12
5. MENU SETTINGS	EN-13
5.1 Menu Navigation	EN-13
5.1.1 Changing Settings	EN-13
5.2 Calibration	EN-14
5.2.1 Calibration Sub-menu (InCal models)	EN-14
5.2.2 Internal Calibration (not applicable to ExCal models)	EN-14
5.2.3 Cal Adjust (not applicable to ExCal models)	EN-14
5.2.4 Span Calibration	EN-14
5.2.5 Linearity Calibration	EN-15
5.3 Balance Setup	EN-17
5.3.1 Filter Level	EN-17
5.3.2 AZT (Auto Zero Tracking)	EN-17
5.3.3 Auto Tare	EN-17
5.3.4 Graduations	EN-18
5.3.5 Date Format	EN-18
5.3.6 Date Setup	EN-18
5.3.7 Time Format	EN-18
5.3.8 Time Setup	EN-19
5.3.9 Brightness	EN-19
5.3.10 Auto Dim	EN-19
5.3.11 Approved Mode	EN-20
5.4 Weighing Units	EN-20
5.5 RS232 Interface Setup	EN-21
5.5.1 Baud Rate	EN-21
5.5.2 Transmission	EN-22
5.5.3 Handshake	EN-22
5.6 Print Settings	EN-22
5.6.1 Stable Only	EN-22
5.6.2 Numeric Only	EN-23
5.6.3 Single Header	EN-23
5.6.4 Auto Print	EN-23
5.6.5 Header	EN-24
5.6.6 Date and Time	EN-24
5.6.7 Balance ID	EN-24
5.6.8 Balance Name	EN-24

5.6.9	User Name	EN-24
5.6.10	Project Name	EN-24
5.6.11	Application Name	EN-24
5.6.12	Result	EN-24
5.6.13	Gross.....	EN-24
5.6.14	Net.....	EN-25
5.6.15	Tare.....	EN-25
5.6.16	Line Feed	EN-25
5.7	GLP.....	EN-25
5.7.1	Header	EN-25
5.7.2	Balance Name	EN-25
5.7.3	User Name	EN-25
5.7.4	Project Name.....	EN-25
5.8	Factory Reset.....	EN-26
5.9	Lockout.....	EN-26
6.	LEGAL FOR TRADE (LFT)	EN-27
6.1	Settings	EN-27
6.2	Verification	EN-27
6.3	Sealing	EN-28
7.	PRINTING	EN-29
7.1	Connecting, configuring and Testing the Printer / Computer Interface	EN-29
7.2	Output format	EN-30
7.3	Printout Examples	EN-30
8.	MAINTENANCE	EN-32
8.1	Calibration	EN-32
8.2	Cleaning	EN-32
8.3	Troubleshooting	EN-32
8.4	Service Information	EN-33
9.	TECHNICAL DATA.....	EN-34
9.1	Specifications	EN-34
9.2	Drawings and Dimensions	EN-42
9.3	Accessories.....	EN-43
9.4	Communication	EN-43
9.4.1	Interface Commands.....	EN-43
9.4.2	RS232 (DB9) Pin Connections	EN-45
10.	SOFTWARE UPDATES.....	EN-45
11.	COMPLIANCE	EN-46

1. INTRODUCTION

1.1 Description

The PR balance is a precision weighing instrument that will provide you with years of service if properly cared for. PR balances are available in capacities from 62 grams to 6200 grams.

1.2 Features

Operation Controls: backlit display, with 3 weighing applications and many features.



1.3 Definition of Signal Warnings and Symbols

Safety notes are marked with signal words and warning symbols. These show safety issues and warnings. Ignoring the safety notes may lead to personal injury, damage to the instrument, malfunctions and false results.

WARNING	For a hazardous situation with medium risk, possibly resulting in injuries or death if not avoided.
CAUTION	For a hazardous situation with low risk, resulting in damage to the device or the property or in loss of data, or injuries if not avoided.
Attention Note	For important information about the product For useful information about the product

Warning Symbols



General Hazard



Electrical Shock Hazard



Alternating current



Direct current

1.4 Safety Precautions



CAUTION: Read all safety warnings before installing, making connections, or servicing this equipment. Failure to comply with these warnings could result in personal injury and/or property damage. Retain all instructions for future reference.

- Verify that the AC adapter's input voltage range and plug type are compatible with the local AC mains power supply.
- Make sure that the power cord does not pose a potential obstacle or tripping hazard.
- Do not position the balance such that it is difficult to reach the power connection.
- The balance is for indoor use only. Do not operate the equipment in hazardous or unstable environments.
- Operate the equipment only under ambient conditions specified in these instructions.
- Do not drop loads on the pan.
- Use the balance only in dry locations.
- Disconnect the equipment from the power supply when cleaning.
- Use only approved accessories and peripherals.
- Service should only be performed by authorized personnel.

2. INSTALLATION

2.1 Unpacking

Carefully remove your PR balance and each of its components from the package. The included components vary depending on the balance model. Save the packaging to ensure safe storage and transport. Please read the manual completely before installing and using the PR balance to avoid incorrect operation.

Components included:

- Balance
- Power adapter + Attaching plug
- Stainless steel pan
- Pan support (for 0.1 g / 0.01 g model only)
- Warranty card

2.2 Select the Location

Avoid heat sources, rapid temperature changes, air current or excessive vibrations. Allow sufficient space.

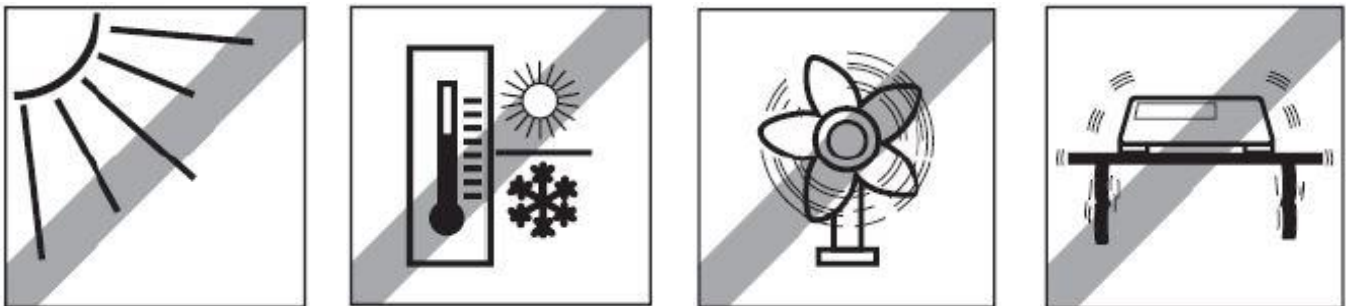

2.3 Leveling

Be sure the balance is level before it is used or after its location is changed.

The PR balance has a level bubble in a small round window beside the display.

To level the balance, adjust the 2 leveling feet until the bubble is centered in the circle.

Please refer to the right figure for leveling.

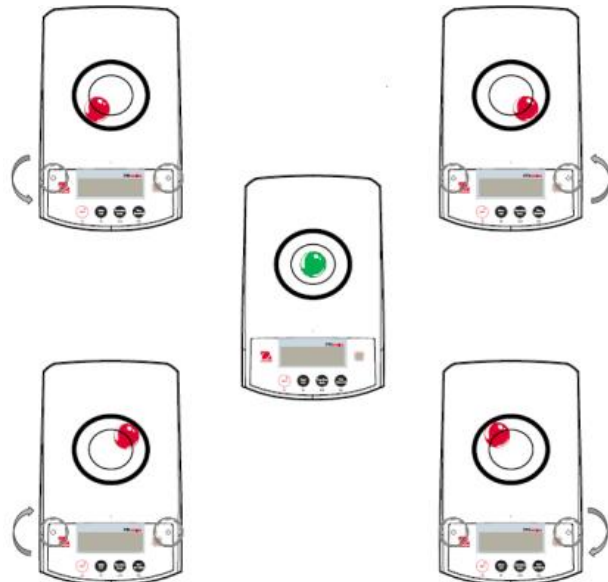

2.4 Connecting Power and Acclimatising the Balance

Connect the DC output connector to the power receptacle on the rear of the balance. Then connect the AC adapter plug to a suitable electrical outlet.

Acclimatising

It is suggested that the balance should not be used until it has been connected to power and acclimatised to the environment for a certain period of time. In the case of a balance with the precision above 0.1 mg, the acclimatisation time should be 1.5 hours; in the case of balance with the precision of 0.01 mg, the acclimatisation time should be more than 4 hours.

2.5 Connecting the Interface

The PR balance has a RS232 port.

Use the RS-232 port to connect either to a computer or a printer with a standard (straight-through) serial cable.

Interface connections on the rear of the balance



RS232

RS232: Used to connect to PC or Printer

Note: See the Printing section for Connecting, Configuring and Testing the Printer / Computer Interface.

2.6 Initial Calibration

When the PR balance is first installed, or when it is moved to another location, it must be calibrated to ensure accurate weighing results. PR balances are classified into two categories, InCal models and ExCal models. InCal models have a built-in calibration mechanism which can calibrate the balance automatically and does not require the use of external calibration masses. If preferred, InCal models can also be manually calibrated with external masses. ExCal models are calibrated with external masses. Make sure to have the appropriate calibration masses available before beginning calibration.





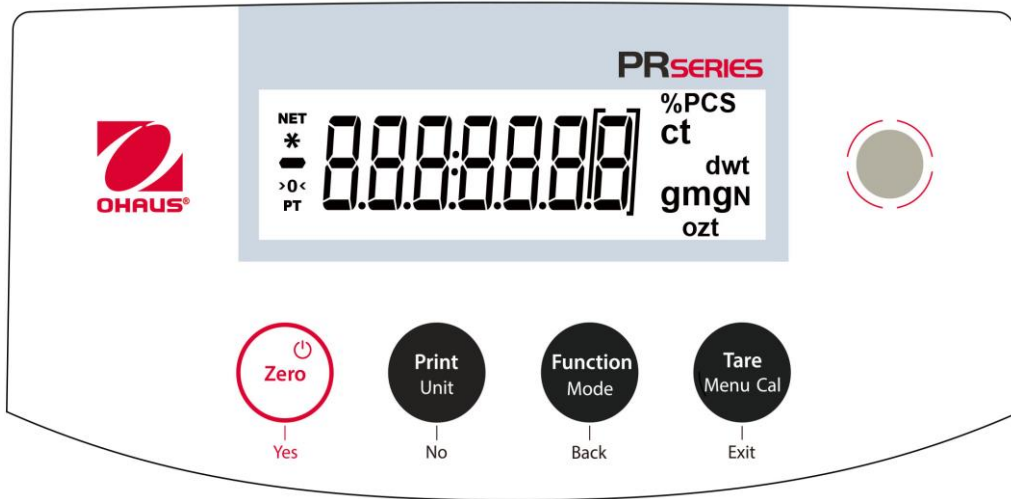

3. OPERATION

3.1 Overview of Controls and Display

CONTROLS



CONTROL FUNCTIONS

Button	 Yes	 No	 Back	 Exit
Primary Function (Short Press) 	On / Zero <ul style="list-style-type: none"> If the balance is Off, turns on the balance. If balance is On, sets zero. 	Print <ul style="list-style-type: none"> Sends the current displayed value to the serial interface. 	Function <ul style="list-style-type: none"> Operation is dependent on the application mode. 	Tare <ul style="list-style-type: none"> Performs tare operation.
Secondary Function (Press and Hold) 	Off <ul style="list-style-type: none"> Zeroing current value. 	Unit <ul style="list-style-type: none"> Changes weighing units. 	Mode <ul style="list-style-type: none"> Changes application mode. 	Menu-Cal <ul style="list-style-type: none"> Enters the main menu. Calibration is the first sub-menu. Views the preset Tare value.
Menu Function (Short Press) 	Yes <ul style="list-style-type: none"> Accepts the current (blinking) setting on the display. 	No <ul style="list-style-type: none"> Rejects the current (blinking) setting on the display. Increments a value being entered. 	Back <ul style="list-style-type: none"> Reverts back to previous menu item. Decrements a value being entered. 	Exit <ul style="list-style-type: none"> Immediately exits the sub-menu. Aborts a calibration in progress.

MAIN APPLICATION SCREEN



3.2 Principal Functions

- Weighing:** First press **Zero** to set the display to zero. Place an object on the pan. The display indicates the gross weight.
- Taring:** With no load on the pan, press **Zero** to set the display to zero. Place an empty container on the pan and press **Tare**. Add objects to the container and its net weight is displayed. After the container and the objects are removed, the load will be displayed as a negative number. Press **Tare** to clear.
- Zero:** Press **Zero** to zero the balance.

3.3 Overview of Parts and Features – Draft Shield Models

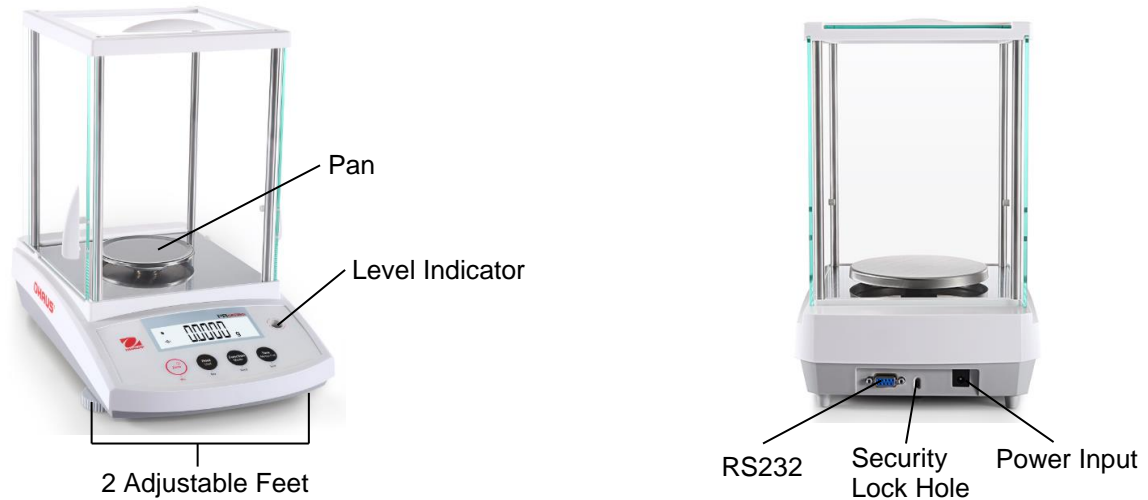

3.4 Overview of Parts and Features – Non-Draft Shield Models

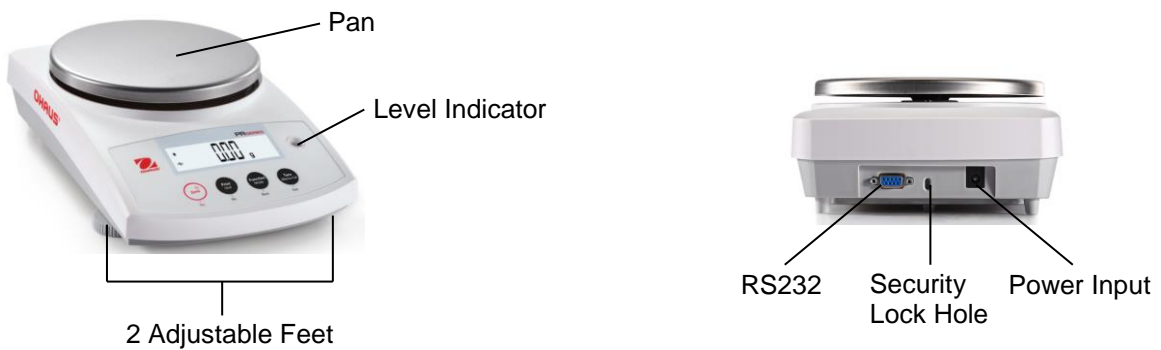

4. APPLICATIONS



The PR balance can be operated in 3 application modes by long pressing the **Function / Mode** button.

4.1 Weighing

Note: Before using any application, be sure the balance has been leveled and calibrated.

Use this application to determine the weight of items in the selected unit of measure.

Weighing

<ol style="list-style-type: none"> 1. Press Tare or Zero if necessary to begin. 2. Press and hold the Function / Mode button to select WEIGH (this application is the default). 	
<ol style="list-style-type: none"> 3. Place objects on the pan to display the weight. Once the reading is stable, the * will appear. 4. The resulting value is displayed in the active unit of measure. 	

Item Settings

To view or adjust the current settings.

- **Weighing Units:** Change the displayed unit. See Section 5.4 for the detailed processes.
- **Filter Level:** Change Filtering level. See Section 5.3.1 for more information.
- **GLP Data:** See Section 5.7 for more information.
- **Print Settings:** Change printing settings. See Section 7 for more information.





4.2 Parts Counting

Note: Before using any application, be sure the balance has been leveled and calibrated. The minimum piece weight should be no less than 0.1d. In the LFT mode, the minimum piece weight is 3e, the minimum Sample Size is 10.

Use this application to count samples of uniform weight.

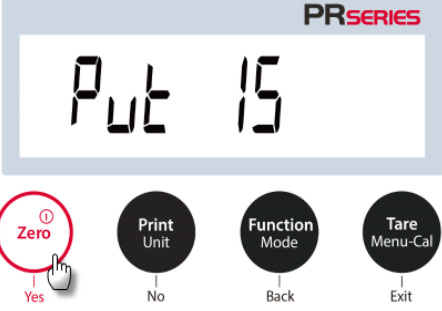

Parts Counting

<ol style="list-style-type: none"> 1. Press Tare or Zero if necessary to begin. 2. Press and hold the Function / Mode button until Count appears. 	
---	--

<p>3. After confirmation by pressing Yes, the message CLr.APW will appear on the screen.</p>	 <p>The display shows 'CLr.APW' with 'PR SERIES' at the top. Below the display are four buttons: 'Zero' (circled in red), 'Print Unit', 'Function Mode', and 'Tare Menu-Cal'. A mouse cursor is pointing at the 'Zero' button.</p>
<p>4. Press Yes, and the message Pwt 15 will display with the numeral 15 (default) flashing. The user can press No or Back to increase or decrease the value. For instance, to increase the value to 15, please press No. Then, Pwt and 15 will flash simultaneously.</p>	 <p>The display shows 'Pwt 15' with 'PR SERIES' at the top. Below the display are four buttons: 'Zero' (circled in red), 'Print Unit', 'Function Mode', and 'Tare Menu-Cal'. A mouse cursor is pointing at the 'Zero' button.</p>
<p>4. Place 15 samples on the pan. Press the Function / Mode button so that the weight of the 15 samples is used to establish the average piece weight (APW). The display will show 15 pieces.</p>	 <p>The display shows '* 15 PCS' with 'PR SERIES' at the top. Below the display are four buttons: 'Zero', 'Print Unit', 'Function Mode' (circled in red), and 'Tare Menu-Cal'. A mouse cursor is pointing at the 'Function Mode' button.</p>
<p>5. Remove the 15 samples from the pan and then place additional samples on the pan. The corresponding number of pieces will display on the screen.</p>	 <p>The display shows '* 20 PCS' with 'PR SERIES' at the top.</p>
<p>6. To view the total weight or the number of pieces of the objects, press the Function / Mode button.</p>	 <p>The display shows '* 4000000 g' with 'PR SERIES' at the top. Below the display are four buttons: 'Zero', 'Print Unit', 'Function Mode' (circled in red), and 'Tare Menu-Cal'. A mouse cursor is pointing at the 'Function Mode' button.</p>

Item Settings

To view or adjust the current settings.

<p>Sample size: The sample size ranges from 1 to 100. The default value is 10.</p> <p>Note: If the APW of the last parts counting operation needs to be kept, the user can press No when the display shows the message CLr.APW (clear the average piece weight. Place additional objects on the pan, and the corresponding number of pieces will display.</p>	
<p>APW Optimization: Improving counting accuracy by re-calculating the piece weight automatically as parts are added.</p> <p>APW Optimization occurs only when the number of pieces added to the pan is between one and three times the number already on the pan.</p>	
<p>Print Settings: Changing printing setup. See Section 7 for more information.</p>	



4.3 Percent Weighing





Note: Before using any application, be sure the balance has been leveled and calibrated.

Use Percent Weighing to display the weight of a test object as a percentage of a pre-established reference sample.

Note: The minimum reference weight should be no less than 0.1d.

Percent Weighing

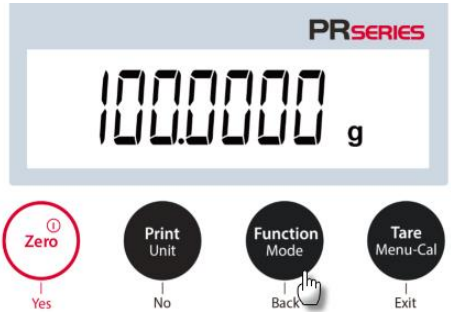
<p>1. Press and hold the Function / Mode button until PERCENT appears.</p>	
<p>2. After confirmation by pressing Yes, the message CLr.rEF (clear the reference) will appear on the screen.</p>	

<p>3. Press Yes, and PUT.rEF (put the reference weight) will display.</p>	
<p>4. Place the reference sample on the pan to display the weight. When the reading is stable, the * appears. 5. Press the Function / Mode button so that the weight of the reference sample is stored in memory. The display will show 100%.</p>	
<p>6. Remove the reference sample, and place the test object on the pan. The ratio of the test object to the reference sample weight is displayed as a percentage.</p>	
<p>7. To view the reference sample weight or the percentage of the test object weight to the reference sample weight, press the Function / Mode button.</p>	
<p>8. To establish a new reference sample weight, long press the Function / Mode button and repeat the steps described above.</p>	

Item Settings

<p>Note: If the reference weight of last Percent Weighing operation needs to be kept, press No when the message CL.rEF (Clear reference) displays.</p>	
---	--

Printing Setup:

Changing printing setup. See Section 7 for more information.

4.4 Additional Features

Weigh Below

Note: Ensure the balance has been leveled and calibrated.

The PR balance is equipped with a weigh below hook for weighing below the balance (as shown below).

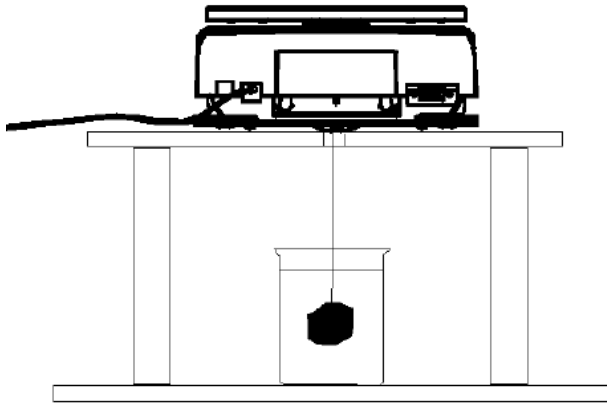

Before turning the balance over, remove the pan and draft shield elements (if present) to prevent damage. Do not place the balance on the pan support cone or load cell pins.

To use this feature, remove power from the balance, then remove the protective cover for the weigh below opening.

Power on the balance, and then use a string or wire to attach items to be weighed.

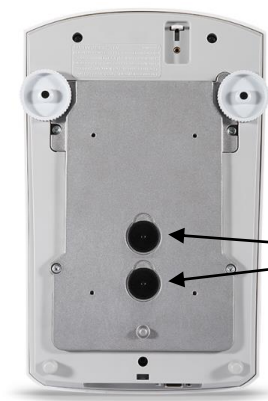

Weigh below protective cover



Weigh below hook

5. MENU SETTINGS

5.1 Menu Navigation

Calibration	Setup	Unit	RS232	Print	GLP	Reset	Lock
InCal	Filter Level	Gram	Baud Rate	Stable Only	Header 1	Reset All	Calibration
Cal Adjust	AZT	Kilogram	Parity	Numeric Only	Header 2		Setup
Span Cal	Auto Tare	Milligram	Handshake	Single Header	Header 3		RS232
Linearity Cal	Graduations	Carat		Auto Print	Balance Name		Print
	Date Format	Pound		Header	User Name		GLP
	Date Setting	Ounce		Date and Time	Project Name		Reset
	Time Format	Ounce Troy		Balance ID			
	Time Setting	Penny Weight *		Balance Name			
	Brightness	Newton		User Name			
	Auto Dim	Grain		Project Name			
	LFT	TW Tael		Application Name			
		Custom 1		Result			
				Gross Weight			
		Net Weight					
		Tare Weight					
		Signature Line					
		Line Feed					

5.1.1 Changing Settings

To change a menu setting, navigate to that setting using the following steps:

Enter the Menu

Long press the Menu button to enter the **Menu**.

Select the Sub-Menu

Press **No** to step between the sub-menus, and press **Yes** to enter the sub-menu.

Select the Menu Item

Press **No** to step through the Menu Items, and press **Yes** to enter the displayed Menu Item.

5.2 Calibration

PR balances offer a choice of three calibration methods: Internal Calibration (for InCal models only), Span calibration and Linearity Calibration.

Attention: Do not disturb the balance during any calibration.

5.2.1 Calibration Sub-menu (InCal models)

Note: ExCal models only have Span Calibration and Linearity Calibration.

5.2.2 Internal Calibration (not applicable to ExCal models)

Calibration is accomplished with the internal calibration mass. Internal Calibration can be performed at any time, provided the balance has warmed up to operating temperature and is level.

With the Balance turned On and no load on the pan, press the **Tare / Menu-Cal** button enter into the internal calibration setting. Or press the **Tare / Menu-Cal** button and select **InCAL** to initiate the internal calibration.

Set the internal calibration functionality.		InCAL Incal
On = enabled Off = disabled. Incal = initiate the internal calibration		
On on	OFF off	InCAL Incal

The screen shows the status, and then press any button to return to the current application after calibration.

5.2.3 Cal Adjust (not applicable to ExCal models)

Use this calibration method to fine tune the effect of the Internal Calibration.

Calibration Adjust may be used to adjust the result of the Internal Calibration by ± 100 divisions.

Note: Before making a calibration adjustment, perform an Internal Calibration. To verify whether an adjustment is needed, place a test mass equal to the **span calibration value** on the pan and note the difference (in divisions) between the nominal mass value and the actual balance reading. If the difference is within +/- division, calibration adjustment is not required. If the difference exceeds +/-1 division, calibration adjustment is recommended.

Example:

Expected weight reading:	200.000g (Test mass value)
Actual weight reading:	200.014g
Difference in grams:	- 0.014g
Difference in divisions:	- 14 (InCal Adjust value)

To perform a Calibration Adjustment, select InCal Adjustment from the list of Calibration Menu; enter the value (positive or negative divisions) to match the difference noted earlier in the procedure.







Recalibrate using Internal Calibration. After calibration, place the test mass on the pan and verify that the mass value now matches the displayed value. If not, repeat the procedure until Internal Calibration reading agrees with the test mass.

5.2.4 Span Calibration

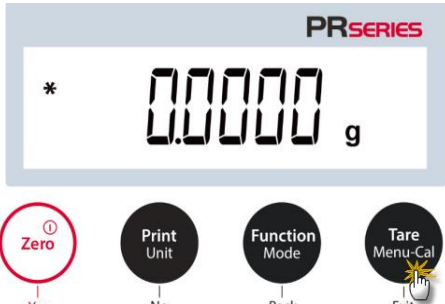
Span calibration uses two calibration points, one at **zero load** and the other at **specified full load** (span). For detailed calibration mass information please refer to the specification tables in the "Span Calibration Points", SPECIFICATIONS, Section 9.

With the balance turned On and no load on the pan, Span Calibration can be performed. The best accuracy is achieved using the mass closest to the full span value.

Steps for span calibration

<p>1. Press and hold the Tare / Menu-Cal button, and the Calibration Menu will display.</p>	
<p>2. Press Yes to enter the Calibration Menu.</p>	
<p>3. To change the calibration mode, press No until SPAN (span calibration) is displayed.</p>	
<p>4. The calibration mass value will be shown in the screen. After the display shows 200.00000 g, please place weight(s) of 200 g on the pan for calibration. To change to the calibration point of half full capacity (e.g. 100 g), press the Function / Mode button. If 0.0000 g is displayed, please take away the mass.</p>	
<p>5. Once the span calibration is completed successfully, CALdone will display. Press any button to return to the previous screen.</p>	
<p>6. Remove the weight, and the reading will be set to zero.</p>	







5.2.5 Linearity Calibration

Linearity calibration uses three calibration points, one at zero load and the others at specified loads.

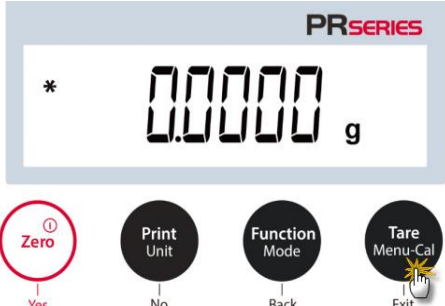
With no load on the balance, press Linearity Calibration to begin the process.

The balance captures the zero point, and then prompts for the next weight.

Continue to follow the instructions on the display until the calibration is completed. Steps for linearity calibration

<p>1. Press and hold the Tare / Menu-Cal button, and the Calibration Menu will display.</p>	
<p>2. Press Yes to enter the Calibration Menu.</p>	
<p>3. To change the calibration mode, press No until LINEAR (linearity calibration) is displayed.</p>	
<p>4. The calibration mass value will be shown in the display. After the display shows 100.00000 g, please place weight(s) of 100 g on the pan for calibration.</p>	
<p>5. Remove the weight of 100 g from the pan. After a while, 200.00000 g will be displayed on the screen. Please place weight(s) of 200 g on the pan.</p>	
<p>6. Once the linearity calibration is completed successfully, CALdone will display. Press any button to return to the previous screen.</p>	
<p>7. Remove the weight, and the reading will be set to zero.</p>	

5.3 Balance Setup

Enter this sub-menu to customize the balance functionality.
Note: The factory default settings are shown below in **bold**.

5.3.1 Filter Level

Set the amount of signal filtering.		F I L T E R
Low = faster stabilization time with less stability. Medium = normal stabilization time with normal stability. High = slower stabilization time with more stability.		
Low Low	Med Medium	HIGH High

5.3.2 AZT (Auto Zero Tracking)

Set the automatic zero tracking functionality.		A Z T Auto Zero Tracking
Off = disabled. 0.5d = display maintains zero up to a drift of 0.5 graduation per second. 1d = display maintains zero up to a drift of 1 graduation per second. 3d = display maintains zero up to a drift of 3 graduations per second.		
0.5 d 0.5 d	1 d 1 d	3 d 3 d

5.3.3 Auto Tare



Set the automatic tare.		
When Automatic Tare is set to On, the first object placed on the pan will be deemed as a container and tared automatically.		
Off = disabled. On = enabled.		
A.T.A.R.E Auto Tare	OFF Off	ON On

5.3.4 Graduations





Set the displayed readability of the balance.

1 Division = standard readability.
 10 Divisions = readability is increased by a factor of 10.



For example, if the standard readability is 0.01 g, selecting 10 Divisions will result in a reading of 0.1 g.

 Graduation	 1 Division	 10 Division
---	---	--



5.3.5 Date Format

Set the current date format. Date Format: YY/MM/DD MM/DD/YY DD/MM/YY	 Date Format	 MM/DD/YYYY
	 DD/MM/YYYY	 YYYY/MM/DD

5.3.6 Date Setup

Set the current date in the desired date format. To set the current date, press No or Back to increase or decrease the value.	 Date
For example, if the current date is 22 nd June, 2017, MM/DD/YY: 06.22.17 DD/MM/YY: 22.06.17 YY/MM/DD: 17.06.22	

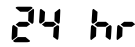
5.3.7 Time Format

Set the time format. Time Format: 24hr 12hr		
 Time Format	 24hr	 12hr

5.3.8 Time Setup

Set the current time in the desired time format.	t .mE
To set the current time, press No or Back to increase or decrease the value.	08.00.00

5.3.9 Brightness

Set the brightness of the display. Medium High Low	br .ght Brightness	mEd Medium
	HIGH High	mEd Low

5.3.10 Auto Dim

Set whether the balance automatically turns off the display backlight of the display.	Aut.d .m	
<p>Off = disabled. 10 minutes = become dim if there is no motion for 10 minutes. 20 minutes = become dim if there is no motion for 20 minutes. 30 minutes = become dim if there is no motion for 30 minutes.</p>		
10 .m in 10 min	20 .m in 20 min	30 .m in 30 min

5.3.11 Approved Mode

Use this menu to set the Legal for Trade status. OFF = standard operation. ON = operation complies with Legal Metrology regulations.	LFL
---	-----

For PRxxxN models:

Use this menu to set the Legal for Trade status. OFF = standard operation. ON 1d = operation complies with Legal Metrology regulations, e=1d ON 10d = operation complies with Legal Metrology regulations, e=10d	LFL
--	-----

Note: When Approved Mode is set to On, the menu settings are affected as follows:

Calibration Menu:

- For InCal models, only Internal Calibration is available. All other functions are hidden.
- For ExCal models, the entire Calibration menu is hidden.

Balance Setup Menu:

- Filter Level is locked at the current setting.
- Auto Zero Tracking is limited to 0.5 Division and Off. The selected setting is locked.
- Auto Tare is locked at current setting.
- Graduations are forced to 1 Division and the menu item is hidden.

Communication Menu (Communication->Print Settings->Print Output):

- Stable Weight Only is locked On.
- Numeric Value Only is locked Off.

Communication Menu (Communication->Print Settings->Auto Print):

- Auto print mode selections are limited to Off, On Stability, and Interval. Continuous is not available.

Lockout Menu:

- Menu is hidden

5.4 Weighing Units

Enter this sub-menu to activate the desired units of measure.



PR balances provide a choice of 12 units, which are all set On by default.

Note: Due to national laws, the balance may not include some of the units of measure listed below.

NTEP model: The Unit menu is used to enable or disable a specific unit. (SET ON, SET OFF).

Unit	Display
Gram	g
Kilogram	kg
Milligram	mg
Carat	ct
Pound	lb
Ounce	oz
Ounce Troy	ozt
Penny weight	dwt
Newton	N
Grain	GN
TW Tael	t
Custom 1	C

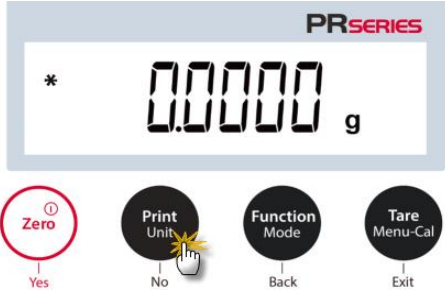
Changing Weighing Units

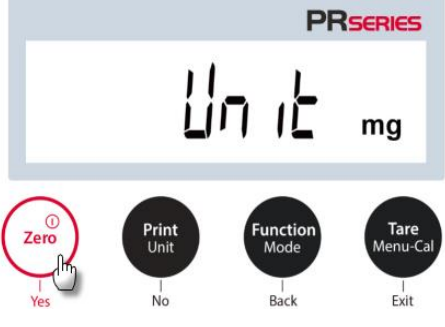
<p>1. Press and hold the Print / Unit button until the <i>Unit Menu</i> is displayed.</p>	
<p>2. The default unit is gram (g). To change the unit, press No to advance to the next unit.</p>	
<p>3. Press Yes to set the unit displayed to the weighing unit.</p>	

5.5 RS232 Interface Setup

<p>Enter this sub-menu to customize RS232 standard settings. Data may be output to either a printer or a PC.</p>	
--	--

5.5.1 Baud Rate

<p>Set the baud rate (bits per second).</p>	
<p>1200 = 1200 bps 2400 = 2400 bps 4800 = 4800 bps 9600 = 9600 bps 19200 = 19200 bps 38400 = 38400 bps</p>	

5.5.2 Transmission

Set the data bits, stop bit, and parity. 8-N-1 = 8 data bits, no parity, stop bit 1 8-N-2 = 8 data bits, no parity, stop bit 2 7-E-1 = 7 data bits, even parity, stop bit 1 7-E-2 = 7 data bits, even parity, stop bit 2 7-N-1 = 7 data bits, no parity, stop bit 1 7-N-2 = 7 data bits, no parity, stop bit 2 7-O-1 = 7 data bits, odd parity, stop bit 1 7-O-2 = 7 data bits, odd parity, stop bit 2	
PARITY Parity	8-N-1 8 data bits, stop bit 1

5.5.3 Handshake

Set the flow control method. NONE = no handshaking XON-XOFF = XON/XOFF handshaking HARDWARE = hardware handshaking	
H.SHAKE Handshake	NONE None
ON-OFF Xon / Xoff	HARDWARE Hardware

5.6 Print Settings

Enter this sub-menu to customize data transfer settings.	Print
--	--------------

5.6.1 Stable Only

Off = values are printed immediately regardless of stability. On = values are printed only when the stability criteria are met.	STABLE
---	---------------

5.6.2 Numeric Only

<p>Off = All results selected are printed. On = Only numeric data values are printed.</p>	<p>NUM7</p>
---	-------------

5.6.3 Single Header

<p>Off = Headers will be printed for every print requirement. On = Headers will be printed once a day.</p>	<p>5 in.HEAD</p>
--	------------------

5.6.4 Auto Print

<p>Enable or disable the functionality of auto print, and set the specific auto print mode.</p>	<p>A.Pr int</p>
---	-----------------

<p>1. Off = disabled</p>	<p>OFF</p>
---------------------------------	------------

<p>2. On Stability = printing occurs when the stability criteria are met.</p>	<p>ON.StAb</p>
--	----------------

<p>When On Stability is selected, set the conditions for printing. Load = Prints when the displayed load is stable.</p>	<p>LoAd</p>
---	-------------

<p>Load and Zero = Prints when the displayed load and zero reading is stable.</p>	<p>LoAd.ZEr</p>
---	-----------------

<p>3. Print Interval = printing occurs at the defined time interval. When Print Interval is selected, set the time interval using the numeric keypad. Note: Settings of 1 to 3600 seconds are available. Default is 0.</p>	<p>intEr</p>
---	--------------

<p>4. Continuous = printing occurs continuously.</p>	<p>Cont inu</p>
---	-----------------

5.6.5 Header

<p>On = the header is printed. Off = the header is not printed.</p>	
--	---

5.6.6 Date and Time

<p>On = the date and the time are printed. Off = neither the date nor the time is printed.</p>	
---	---

5.6.7 Balance ID

<p>On = the balance ID is printed. Off = the balance ID is not printed.</p>	
--	---

5.6.8 Balance Name

<p>On = the balance name is printed. Off = the balance name is not printed.</p>	
--	---

5.6.9 User Name

<p>On = the user name is printed. Off = the user name is not printed.</p>	
--	---

5.6.10 Project Name

<p>On = the project name is printed. Off = the project name is not printed.</p>	
--	---

5.6.11 Application Name

<p>On = the application name is printed. Off = the application name is not printed.</p>	
--	---

5.6.12 Result

<p>On = the weighing result is printed. Off = the weighing result is not printed.</p>	
--	---

5.6.13 Gross

<p>On = the gross weight is printed. Off = the gross weight is not printed.</p>	<p>Gross</p>
---	--------------

5.6.14 Net

<p>On = the net weight is printed. Off = the net weight is not printed.</p>	<p>NET</p>
---	------------

5.6.15 Tare

<p>On = the tare weight is printed. Off = the tare weight is not printed.</p>	<p>TARE</p>
---	-------------

5.6.16 Signature Line

<p>On = the Signature Line is printed. Off = the Signature Line is not printed.</p>	<p>SIGN.L IN</p>
--	------------------

5.6.17 Line Feed

<p>1 Line = move the paper up one line after printing. 4 Lines = move the paper up four lines after printing.</p>	<p>FEED</p>
<p>1 Line 1 Line</p>	<p>4 Lines 4 Lines</p>

5.7 GLP

<p>Enter this menu to set the Good Laboratory Practices (GLP).</p>	<p>GLP</p>
--	------------

5.7.1 Header

<p>Enables the printing of GLP headings. There are up to 3 headings available. Alphanumeric settings up to 16 characters are available for each Header setting.</p>	<p>HEAdEr 1 Header 1</p>
<p>HEAdEr 2 Header 2</p>	<p>HEAdEr 3 Header 3</p>

5.7.2 Balance Name

<p>Set the balance name. Alphanumeric settings up to 16 characters are available for each Header setting.</p>	<p>BAL.NAM7</p>
---	-----------------

5.7.3 User Name

<p>Set the user name. Alphanumeric settings up to 16 characters are available for each Header setting.</p>	<p>USR.NAM7</p>
--	-----------------

5.7.4 Project Name

<p>Set the user name. Alphanumeric settings up to 16 characters are available for each Header setting. The default is blank.</p>	<p>PRJ.NAM7</p>
---	-----------------

5.8 Factory Reset

<p>Use this sub-menu to reset the all menu settings to their Factory default settings. Reset All = resets all menus to their factory default settings. Exit = return to application main screen without resetting any menus.</p>	<p>rESET</p>
--	--------------

5.9 Lockout

<p>Use this sub-menu to lock / unlock certain menus. Off = the menu is unlocked. On = the menu is locked.</p>	<p>LOCK</p>
---	-------------

6. LEGAL FOR TRADE (LFT)

When the balance is used in trade or a legally controlled application it must be set up, verified and sealed in accordance with local weights and measures regulations. It is the responsibility of the purchaser to ensure that **all pertinent legal requirements** are met.

6.1 Settings

Before verification and sealing, perform the following steps in order:

1. Verify that the menu settings meet the local weights and measures regulations.
2. Verify the units enabled meet the local weights and measures regulations.
3. Perform a calibration as explained in the Calibration section.
4. Enter the Calibration menu and set the Internal Calibration, making sure that they meet the local weights and measures regulations.
 - a) Press the **Tare / Menu-Cal** button and select **InCal**.
 - b) Press the **Print/Unit** button to toggle the Internal Calibration setting **On** or **Off** .
Attention: Internal Calibration must be disabled when the balance is used for trade in Canada.
 - c) Press the **Zero** button to confirm, and then Press the **Tare / Menu-Cal** button to exit the menu.
5. Enable the Approved Mode in the Balance Setup menu. For models with selectable graduation size, set the desired value in the LFT menu as explained in Section **Approved Mode**.
6. For Measurement Canada and NTEP Certified models with selectable graduation size, attach the appropriate capacity and readability label to the balance in the location shown below.
 - a) Retrieve the set of two labels from the packaging.
 - b) Take the label that corresponds to the graduation size set in the LFT menu.
 - c) Remove the clear plastic protective cover from the terminal, if present.
 - d) Remove the liner from the adhesive backing and attach the label to the area above the display.
 - e) Reinstall the clear plastic protective cover, if present.

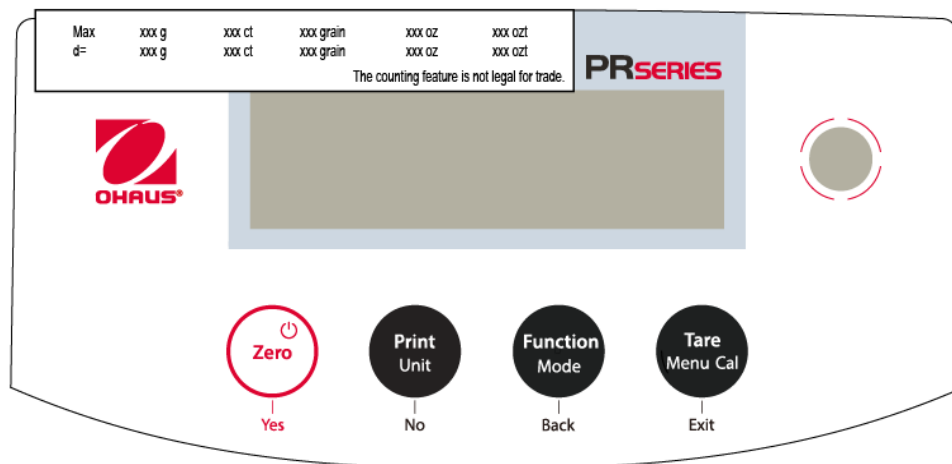

Note: When Approved Mode is set to On, external calibration can't be performed.

6.2 Verification

A weights and measures official or authorized service agent must perform the verification procedure.

6.3 Sealing

After the Balance has been verified, it must be sealed to prevent undetected access to the legally controlled settings. Before sealing the device, ensure the Approved Mode setting in the Balance Setup menu has been set to ON.

- If using a paper seal, place seals over the security switch and the bottom housing as shown.
- If using a wire seal, pass the sealing wire through the holes in the security screw and the bottom housing as shown.

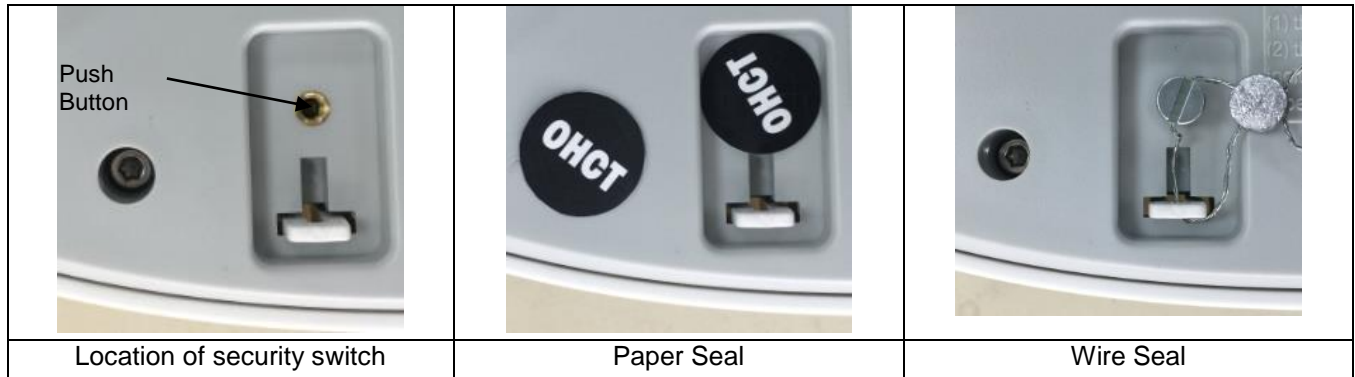

Figure 6-1. Sealing

7. PRINTING

7.1 Connecting, configuring and Testing the Printer / Computer Interface

Use the built-in RS-232 Port to connect either to a computer or a printer.
If connecting to a computer, use HyperTerminal or similar software like SPDC described below.

(Find HyperTerminal under **Accessories/Communications** in Windows XP.)

Connect to the computer with a standard (straight-through) serial cable.

Choose **New Connection**, “connect using” COM1 (or available COM port).

Select **Baud=9600; Parity=8 None; Stop=1; Handshaking=None**. Click **OK**.

Choose Properties/Settings, then ASCII Setup. Check boxes as illustrated:
(**S**end line ends...; **E**cho typed characters...; **W**rap lines...)

Use RS232 Interface Commands (Section 9.6.1) to control the balance from a PC.

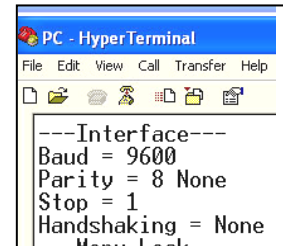

SPDC Software

The Serial Port Data Collection / SPDC software is provided by Ohaus and can be used on operating systems that do not have the HyperTerminal software mentioned above. SPDC software can preliminarily collect and transfer the data to Microsoft files (such as Excel, Word, etc.).

Choose the export file type and export file path and then press Run as shown below.

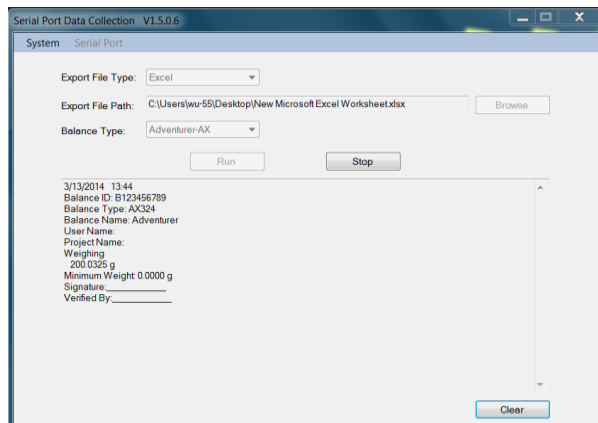

System Requirements

- PC running Windows 98®, Windows 98SE®, Windows ME®, Windows 2000®, Windows XP®, Windows 7® or Windows 8® (32-bit).

Note: **The latest SPDC software support English and Chinese language and can be downloaded from the Ohaus' website. For more information, refer to the *SPDC Data Collection Instruction Manual*.**

7.2 Output format

The Result Data, and G/N/T data, is output in the following format.

Field:	Label ¹	Space ²	Weight ³	Space ²	Unit ⁴	Space	Stability ⁵	Space	G/N ⁶	Space	Term. Characters ⁷
Length:		1	11	1	5	1	≤ 1	≤ 1	≤ 3	0	≤ 8

Note:

1. The length of the label field is not fixed.
2. Each field is followed by a single delimiting space (ASCII 32).
3. The Weight field is 11 right justified characters. If the value is negative, the '-' character is located at the immediate left of the most significant digit.
4. The Unit field contains the unit of measure abbreviation up to 5 characters, right justified.
5. The Stability field contains the "?" character if the weight reading is not stable. The Stability field and the following Space field are omitted if the weight reading is stable.
6. The G/N field contains the net or gross indication. For net weights, the field contains "N". For gross weights, the field contains "G".
7. The Termination Characters field contains CRLF, Four CRLF or Form Feed (ASCII 12), depending on the LINE FEED menu setting.
8. When Numeric Only is set On, only the Weight Field is printed, left-aligned.

7.3 Printout Examples

Examples for each Application are shown with all items turned **ON** in the **Print** menu. The default values for **Header** lines 1-3 are also shown.

Basic Weighing

```

Header 1
Header 2
Header 3
07/19/2017 17:56:23
Balance ID: B234567890
Balance Name: PR4202/E
User Name:
Project Name:
Weigh
    0.10 g
Gross:    0.10 g G
Net:      0.10 g N
Tare:     0.00 g T

Signature: _____
Verified By: _____
    
```

Count Weighing

```

Header 1
Header 2
Header 3
07/19/2017 17:57:19
Balance ID: B234567890
Balance Name: PR4202/E
User Name:
Project Name:
Count
Quantity: 4999 PCS
Gross:    49.99 g G
Net:      49.99 g N
Tare:     0.00 g T
APW: 0.010 g
Sample Size: 10 PCS

Signature: _____
Verified By: _____
    
```

Percent Weighing

```

Header 1
Header 2
Header 3
07/19/2017 17:57:19
Balance ID: B234567890
Balance Name: PR223/E
User Name:
Project Name:
Percent
Percentage: 10.156 % N
Gross:    23.361 g G
Net:      10.156 g N
Tare:     13.205 g T
Reference weight: 100.000 g

Signature: _____
Verified By: _____
    
```

Internal Calibration

-OHAUS-
07/26/2017 05:16:53
Balance ID:
Balance Name: PR2202
User Name:
Project Name:
---Internal Calibration---
Calibration is done.
Difference weight: 0.00 g

Signature: _____
Verified By: _____

Span Calibration

-OHAUS-
07/26/2017 05:16:37
Balance ID:
Balance Name: PR2202
User Name:
Project Name:
---Span Calibration---
Calibration is done.
Reference weight: 2000.00 g
Actual weight: 2000.22 g
Difference weight: 0.22 g
Weight ID: _____

Signature: _____
Verified By: _____

Linearity Calibration

-OHAUS-
07/26/2017 05:16:11
Balance ID:
Balance Name: PR2202
User Name:
Project Name:
---Linear Calibration---
Calibration is done.

Signature: _____
Verified By: _____

8. MAINTENANCE

8.1 Calibration

Periodically verify calibration by placing an accurate weight on the balance and viewing the result. If calibration is required, refer to section 5.2 for instructions.

8.2 Cleaning



WARNING: Disconnect the balance from the power supply before cleaning. Make sure that no liquid enters the interior of the balance.

Clean the Balance at regular intervals.





Housing surfaces may be cleaned with a lint-free cloth slightly dampened with water or a mild cleaning agent.



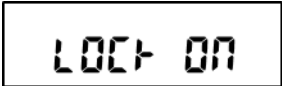
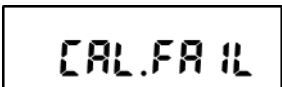

Glass surfaces may be cleaned with a commercial glass cleaner.

Attention: Do not use solvents, harsh chemicals, ammonia or abrasive cleaning agents.

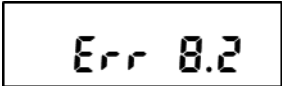
8.3 Troubleshooting

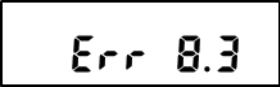
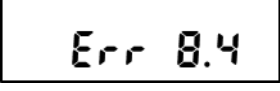
TABLE 8-1 TROUBLESHOOTING

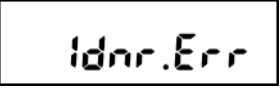
Symptom / Display	Possible Cause	Remedy
Cannot change menu settings 	The sub-menu is locked.	Unlock the sub-menu in Lockout Menu.
Certain sub-menu is hidden.	This is an approved model, which requests to block certain sub-menu.	Setup the balance before you turn on the Legal for Trade setting.
	The environment is not stable.	Move balance to a suitable location and calibrate again
	Incorrect calibration masses are used.	Use calibration masses to calibrate according to the correct calibration points in the specification table in the instruction manual.
	System error	If error persists, please contact OHAUS service (www.ohaus.com - More - Contact Us)
	A wrong weighing pan is used when power on.	Use OHAUS original weighing pan before power on.
	The load on the pan is over the initial weight setting.	Remove the load from the pan before power on.
	A wrong weighing pan is used when power on.	Use OHAUS original weighing pan before power on.
	The pan is not installed when power on.	Install the weighing pan before power on.

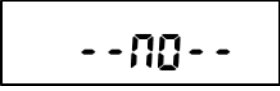
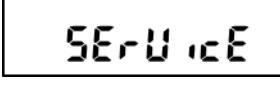
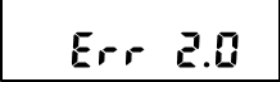
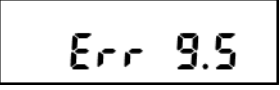
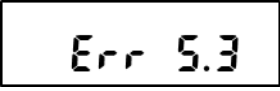
	<p>The weight on the pan is too heavy.</p>	<p>Reduce sample size until the weight is within the weighing capacity.</p>
	<p>The pan is not properly installed.</p>	<p>Install the weighing pan properly</p>
	<p>The average piece weight of the sample is too small (less than 0.1d) in Parts Counting mode.</p>	<p>Recalculate the APW value. If error persists, please use a different sample.</p>
	<p>The reference weight on the pan is too small (less than 100d) in Percent Weighing mode.</p>	<p>Put more samples on the pan</p>
	<p>System error</p>	<p>Please contact OHAUS service (www.ohaus.com - More - Contact Us)</p>
	<p>The environment is not stable.</p>	<p>Move balance to a suitable location</p>
<p>When pressing Tare/Zero</p> 	<p>The value is out of zero range. The zero range is dependent on region.</p>	<p>Perform zero again according to regional requirement.</p>
	<p>The tare value is a negative value.</p>	<p>Press Zero instead of Tare</p>
	<p>System error</p>	<p>Please contact OHAUS service (www.ohaus.com - More - Contact Us)</p>
  	<p>System error</p>	<p>Disconnect the power and restart. If error persists, please contact OHAUS service (www.ohaus.com - More - Contact Us)</p>

8.4 Service Information

If the troubleshooting section does not resolve your problem, contact an Authorized Ohaus Service Agent. Please visit our website www.ohaus.com to locate the Ohaus office nearest you.

9. TECHNICAL DATA

9.1 Specifications

Ambient conditions

- Indoor use only
- Altitude: Up to 2000 m
- Specified Temperature range: 10°C to 30°C
- Humidity: maximum relative humidity 80% for temperatures up to 30°C, decreasing linearly to 50% relative humidity at 40°C
- Operability is assured at ambient temperatures between 5°C and 40°C
- Mains supply voltage fluctuations: up to $\pm 10\%$ of the nominal voltage
- Installation category II
- Pollution degree: 2
- Supply voltage: $12V=0.5A$

Materials

- Bottom Housing: Die-cast Aluminum, Painted + Plastic (HIPS)
- Top Housing: Plastic (HIPS)
- Weighing Platforms: Stainless steel
- Draft Shield: Glass, plastic (HIPS)
- Feet: Plastic (ABS)

Table 9-1 SPECIFICATIONS

InCal Model		PR124	PR224	PR223	PR423	PR523
ExCal Model	PR64/E	PR124/E	PR224/E	PR223/E	PR423/E	PR523/E
Capacity (g)	62	120	220	220	420	520
Readability d (g)	0.0001	0.0001	0.0001	0.001	0.001	0.001
Repeatability (sd.), ≤5% of Full Load (g)	0.00008	0.00008	0.00008	0.0008	0.0008	0.0008
Repeatability (sd.), 5% of Full Load to Full Range (g)	0.0001	0.0001	0.0001	0.001	0.001	0.001
Linearity Deviation, Typical (g)	± 0.00006	± 0.00006	± 0.00006	±0.0006	±0.0006	±0.0006
Linearity Deviation (g)	± 0.0002	± 0.0002	± 0.0002	±0.002	±0.002	±0.002
Stabilization Time Typical (s)	3	3	3	2	2	2
Sensitivity Temperature Drift (PPM/K)	±3	±3	±3	±8	±3	±3
Typical Minimum Weight USP (USP K=2,U=0.10%)	160 mg	160 mg	160 mg	1.6 g	1.6 g	1.6 g
Optimized Min-Weight (USP, u=0.10%, k=2) SRP ≤ 0.41d*	82 mg	82 mg	82 mg	0.82 g	0.82 g	0.82 g
Units	Gram, Milligram, Carat, Newton, Ounce, Ounce Troy, Pennyweight, Grain, TW Tael, Custom 1			Gram, Milligram, Kilogram, Carat, Newton, Ounce, Ounce Troy, Pennyweight, Grain, Pound, TW Tael, Custom 1		
Applications	Basic Weighing; Parts counting; Percent weighing					
Platform Size (diameter)	3.5 in / 9 cm	3.5 in / 9 cm	3.5 in / 9 cm	4.7 in / 12 cm	4.7 in / 12 cm	4.7 in / 12 cm
Span Calibration Points (g)	50, 60	50, 100	100, 200	100, 200	200, 400	300, 500
Linearity Calibration Points (g)	0, 30, 60	0, 50, 100	0, 100, 200	0, 100, 200	0, 200, 400	0, 250, 500
Tare Range	To capacity by subtraction					
Power Supply	Power input: 100-240 V ~ 200 mA 50-60Hz 12-18VA Power output: 12 VDC 0.5A					
Assembled Dimensions (W x D x H)	201 x 317 x 303 mm 7.9 x 12.5 x 11.9 inch					
Communication	RS232					
Operating Temperature Range	Operating conditions for ordinary lab application: +10°C to 30°C (operability guaranteed between +5°C and 40°C).					
Storage Temperature Range	Humidity: maximum relative humidity 80 % for temperatures up to 30°C, decreasing linearly to 50% relative humidity at 40°C					
Storage Conditions	-10°C to 60°C, humidity 10% to 90%, without condensation					
Net Weight	10 lb / 4.5 kg	10 lb / 4.5 kg	10 lb / 4.5 kg	10 lb / 4.5 kg	10 lb / 4.5 kg	10 lb / 4.5 kg
Shipping Weight	15.4lb / 7 kg	15.4lb / 7 kg	15.4lb / 7 kg	15.4lb / 7 kg	15.4lb / 7 kg	15.4lb / 7 kg
Shipping Dimensions (W x D x H)	507 x 387 x 531 mm 20*15*21 inch					

*SRP refers to the standard deviation for n replicate weightings (n ≥ 10).

Table 9-2 SPECIFICATIONS (continued)

InCal Model	PR1602	PR2202	PR4202		PR4201	PR6201
ExCal Model	PR1602/E	PR2202/E	PR4202/E	PR2201/E	PR4201/E	PR6201/E
Capacity (g)	1600	2200	4200	2200	4200	6200
Readability d (g)	0.01	0.01	0.01	0.1	0.1	0.1
Repeatability (sd.), ≤5% of Full Load (g)	0.008	0.008	0.008	0.08	0.08	0.08
Repeatability (sd.), 5% of Full Load to Full Range (g)	0.01	0.01	0.01	0.1	0.1	0.1
Linearity Deviation, Typical (g)	±0.006	±0.006	±0.006	±0.06	±0.06	±0.06
Linearity Deviation (g)	±0.02	±0.02	±0.02	±0.2	±0.2	±0.2
Stabilization Time Typical (s)	1	1	1	1	1	1
Sensitivity Temperature Drift (PPM/K)	±6	±6	±3	±10	±10	±10
Typical Minimum Weight USP (USP K=2,U=0.10%)	16 g	16 g	16 g	160 g	160 g	160 g
Optimized Min-Weight (USP, u=0.10%, k=2) SRP ≤ 0.41d*	8.2 g	8.2 g	8.2 g	82 g	82 g	82 g
Units	Gram, Kilogram, Carat, Newton, Pound, Ounce, Ounce Troy, Pennyweight, Grain, TW Tael, Custom 1					
Applications	Basic Weighing; Parts counting; Percent weighing					
Platform Size (diameter)	7.1 in / 18 cm	7.1 in / 18 cm	7.1 in / 18 cm	7.1 in / 18 cm	7.1 in / 18 cm	7.1 in / 18 cm
Span Calibration Points (g)	1000, 1500, 1600	1000, 2000	2000, 4000	1000, 2000	2000, 4000	5000, 6000
Linearity Calibration Points (g)	0, 800, 1600	0, 1000, 2000	0, 2000, 4000	0, 1000, 2000	0, 2000, 4000	0, 3000, 6000
Tare Range	To capacity by subtraction					
Power Supply	Power input: 100-240 V ~ 200 mA 50-60Hz 12-18VA Power output: 12 VDC 0.5A					
Assembled Dimensions (W x D x H)	201 x 317 x 93 mm 7.9 x 12.5 x 3.7 inch					
Communication	RS232					
Operating Temperature Range	Operating conditions for ordinary lab application: +10°C to 30°C (operability guaranteed between +5°C and 40°C).					
Storage Temperature Range	Humidity: maximum relative humidity 80 % for temperatures up to 30°C, decreasing linearly to 50% relative humidity at 40°C					
Storage Conditions	-10°C to 60°C, humidity 10% to 90%, without condensation					
Net Weight	7.7 lb / 3.5 kg					
Shipping Weight	11 lb / 5 kg					
Shipping Dimensions (W x D x H)	550 x 385 x 291 mm 22 x 15 x 12 inch					

*SRP refers to the standard deviation for n replicate weightings (n ≥ 10).

Table 9-3 SPECIFICATIONS (continued)

InCal Model	PR523N	
ExCal Model	PR323N/E	PR523N/E
Capacity (g)	320	520
Readability d (g)	0.001 or 0.01	0.001 or 0.01
Verification interval e(g)	0.01	0.01
Class	II	II
Repeatability (sd.), ≤5% of Full Load (g)	0.0008	0.0008
Repeatability (sd.), 5% of Full Load to Full Range (g)	0.001	0.001
Linearity Deviation, Typical (g)	± 0.0006	± 0.0006
Linearity Deviation (g)	± 0.002	± 0.002
Eccentric Load	Not exceeding the maximum permissible error for the one-third of the full capacity of the balance	
Stabilization Time Typical (s)	2	2
Sensitivity Temperature Drift (PPM/K)	±3	±3
Typical Minimum Weight USP (USP K=2,U=0.10%)	1.6g	1.6g
Optimized Min-Weight (USP, u=0.10%, k=2) SRP ≤ 0.41d*	0.82g	0.82g
Units	Gram, Milligram, Carat, Ounce, Ounce Troy, Grain	
Applications	Basic Weighing; Parts counting; Percent weighing	
Platform Size (diameter)	4.7 in / 12 cm	4.7 in / 12 cm
Span Calibration Points (g)	200,300	300, 500
Linearity Calibration Points (g)	0, 150, 300	0, 250, 500
Tare Range	To capacity by subtraction	
Power Supply	Power input: 100-240 V ~ 200 mA 50-60Hz 12-18VA Power output: 12 VDC 0.5A	
Assembled Dimensions (W x D x H)	201 x 317 x 303 mm 7.9 x 12.5 x 11.9 inch	
Communication	RS232	
Operating Temperature Range	Operating conditions for ordinary lab application: +10°C to 30°C (operability guaranteed between +5°C and 40°C).	
Storage Temperature Range	Humidity: maximum relative humidity 80 % for temperatures up to 30°C, decreasing linearly to 50% relative humidity at 40°C	
Storage Conditions	-10°C to 60°C, humidity 10% to 90%, without condensation	
Net Weight	10 lb / 4.5 kg	10 lb / 4.5 kg
Shipping Weight	15.4lb / 7 kg	15.4lb / 7 kg
Shipping Dimensions (W x D x H)	507 x 387 x 531mm 20 x 15 x 21 inch	

*SRP refers to the standard deviation for n replicate weightings (n ≥ 10).

Table 9-4 SPECIFICATIONS (continued)

ExCal Model	PR322N/E	PR522N/E	PR822N/E	PR2202N/E	PR4202N/E	PR5202N/E
Capacity (g)	320	520	820	2200	4200	5200
Readability d (g)	0.01	0.01	0.1	0.01 or 0.1	0.01 or 0.1	0.01 or 0.1
Verification interval e(g)	0.01	0.01	0.1	0.1	0.1	0.1
Class	II	II	III	II	II	II
Repeatability (sd.), $\leq 5\%$ of Full Load (g)	0.008	0.008	0.008	0.008	0.008	0.008
Repeatability (sd.), 5% of Full Load to Full Range (g)	0.01	0.01	0.01	0.01	0.01	0.01
Linearity Deviation, Typical (g)	± 0.006	± 0.006	± 0.006	± 0.006	± 0.006	± 0.006
Linearity Deviation (g)	± 0.02	± 0.02	± 0.02	± 0.02	± 0.02	± 0.02
Eccentric Load	Not exceeding the maximum permissible error for the one-third of the full capacity of the balance					
Stabilization Time Typical (s)	1	1	1	1	1	1
Sensitivity Temperature Drift (PPM/K)	± 3	± 3	± 6	± 6	± 3	± 3
Typical Minimum Weight USP (USP K=2,U=0.10%)	16g	16g	16g	16g	16g	16g
Optimized Min-Weight (USP, $u=0.10\%$, $k=2$) SRP $\leq 0.41d^*$	8.2g	8.2g	8.2g	8.2g	8.2g	8.2g
Units	Gram, Kilogram, Carat, Pound, Ounce, Ounce Troy, Grain					
Applications	Basic Weighing; Parts counting; Percent weighing					
Platform Size (diameter)	4.7 in / 12 cm			7.1 in / 18 cm		
Span Calibration Points (g)	200, 300	300,500	500,800	1000, 2000	2000, 4000	3000, 5000
Linearity Calibration Points (g)	0, 150, 300	0, 250, 500	0, 400, 800	0, 1000, 2000	0, 2000, 4000	0, 2500, 5000
Tare Range	To capacity by subtraction					
Power Supply	Power input: 100-240 V ~ 200 mA 50-60Hz 12-18VA;			Power output: 12 VDC 0.5A		
Assembled Dimensions (W x D x H)	201 x 317 x 303 mm 7.9 x 12.5 x 11.9 inch			201 x 317 x 93 mm 7.9 x 12.5 x 3.7 inch		
Communication	RS232					
Operating Temperature Range	Operating conditions for ordinary lab application: +10°C to 30°C (operability guaranteed between +5°C and 40°C).					
Storage Temperature Range	Humidity: maximum relative humidity 80 % for temperatures up to 30°C, decreasing linearly to 50% relative humidity at 40°C					
Storage Conditions	-10°C to 60°C, humidity 10% to 90%, without condensation					
Net Weight	10 lb / 4.5 kg			7.7 lb / 3.5 kg		
Shipping Weight	15.4 lb / 7 kg			11 lb / 5 kg		
Shipping Dimensions (W x D x H)	507 x 387 x 531 mm 20 x 15 x 21 inch			550 x 385 x 291 mm 22 x 15 x 12 inch		

*SRP refers to the standard deviation for n replicate weightings ($n \geq 10$).

Table 9-5 SPECIFICATIONS (continued)

ExCal Model	PR2201N/E	PR4201N/E	PR5201N/E	PR6201N/E
Capacity (g)	2200	4200	5200	6200
Readability d (g)	0.1	0.1	0.1	0.1 or 1
Verification interval e(g)	0.1	0.1	0.1	1
Class	II	II	II	III
Repeatability (sd.), $\leq 5\%$ of Full Load (g)	0.08	0.08	0.08	0.08
Repeatability (sd.), 5% of Full Load to Full Range (g)	0.1	0.1	0.1	0.1
Linearity Deviation, Typical (g)	± 0.06	± 0.06	± 0.06	± 0.06
Linearity Deviation (g)	± 0.2	± 0.2	± 0.2	± 0.2
Eccentric Load	Not exceeding the maximum permissible error for the one-third of the full capacity of the balance			
Stabilization Time Typical (s)	1	1	1	1
Sensitivity Temperature Drift (PPM/K)	± 10	± 10	± 3	± 10
Typical Minimum Weight USP (USP K=2,U=0.10%)	160g	160g	160g	160g
Optimized Min-Weight (USP, $u=0.10\%$, $k=2$) SRP $\leq 0.41d^*$	82g	82g	82g	82g
Units	Gram, Kilogram, Carat, Pound, Ounce, Ounce Troy, Grain			
Applications	Basic Weighing; Parts counting; Percent weighing			
Platform Size (diameter)	7.1 in / 18 cm			
Span Calibration Points (g)	1000, 2000	2000, 4000	3000, 5000	5000, 6000
Linearity Calibration Points (g)	0, 1000, 2000	0, 2000, 4000	0, 2500, 5000	0, 3000, 6000
Tare Range	To capacity by subtraction			
Power Supply	Power input: 100-240 V ~ 200 mA 50-60Hz 12-18VA; Power output: 12 VDC 0.5A			
Assembled Dimensions (W x D x H)	201 x 317 x 93 mm 7.9 x 12.5 x 3.7 inch			
Communication	RS232			
Operating Temperature Range	Operating conditions for ordinary lab application: +10°C to 30°C (operability guaranteed between +5°C and 40°C).			
Storage Temperature Range	Humidity: maximum relative humidity 80 % for temperatures up to 30°C, decreasing linearly to 50% relative humidity at 40°C			
Storage Conditions	-10°C to 60°C, humidity 10% to 90%, without condensation			
Net Weight	7.7 lb / 3.5 kg			
Shipping Weight	11 lb / 5 kg			
Shipping Dimensions (W x D x H)	550 x 385 x 291 mm 22 x 15 x 12 inch			

*SRP refers to the standard deviation for n replicate weightings ($n \geq 10$).

Table 9-6 SPECIFICATIONS (continued)

InCal Approval Model	PR124M	PR224M	PR223M	PR323M	PR423M	PR523M
Capacity (g)	120	220	220	320	420	520
Readability d (g)	0.0001	0.0001	0.001	0.001	0.001	0.001
Verification Interval e (g)	0.001	0.001	0.01	0.01	0.01	0.01
Class	I	I	II	II	II	II
Repeatability (sd.), ≤5% of Full Load (g)	0.00008	0.00008	0.0008	0.0008	0.0008	0.0008
Repeatability (sd.), 5% of Full Load to Full Range (g)	0.0001	0.0001	0.001	0.001	0.001	0.001
Linearity Deviation, Typical (g)	± 0.00006	± 0.00006	±0.0006	±0.0006	±0.0006	±0.0006
Linearity Deviation (g)	± 0.0002	± 0.0002	±0.002	±0.002	±0.002	±0.002
Stabilization Time Typical (s)	3	3	2	2	2	2
Sensitivity temperature drift (PPM/K)	±3	±3	±3	±3	±3	±3
Typical Minimum Weight USP (USP K=2,U=0.10%)	160 mg	160 mg	1.6 g	1.6 g	1.6 g	1.6 g
Optimized Min-Weight (g) (USP, u=0.10%, k=2) SRP ≤ 0.41d*	82 mg	82 mg	0.82 g	0.82 g	0.82 g	0.82 g
Units	g, mg, ct					
Applications	Basic Weighing, Parts Counting, Percent Weighing, Dynamic Weighing, Density Determination					
Platform Size (diameter, mm)	90	90	120	120	120	120
Span Calibration Points (g)	50, 100	100, 200	100, 200	200, 300	200, 400	300, 500
Linearity Calibration Points (g)	0, 50, 100	0, 100, 200	0, 100, 200	0, 150, 300	0, 200, 400	0, 250, 500
Tare Range	To capacity by subtraction					
Power Supply	Power input: 100-240V ~ 200mA 50-60Hz 12-18VA Power output: 12 VDC 0.5A					
Assembled Dimensions (W x D x H) (mm)	209 x 321 x 309					
Communication	RS232					
Operating Temperature Range	Operating conditions for ordinary lab application: +10°C to 30°C (operability guaranteed between +5°C and 40°C).					
Storage Temperature Range	Humidity: maximum relative humidity 80% for temperatures up to 30°C, decreasing linearly to 50% relative humidity at 40°C					
Storage Conditions	-10°C to 60°C, humidity 10% to 90%, without condensation					
Net Weight	10 lb / 4.5 kg					
Shipping Weight	15.4 lb / 7 kg					
Shipping Dimensions (W x D x H) (mm)	507 x 387 x 531					

*SRP refers to the standard deviation for n replicate weightings (n ≥ 10).

Table 9-7 SPECIFICATIONS (continued)

InCal Approval Model	PR1602M	PR2202M	PR4202M	PR5202M	PR4201M	PR6201M
Capacity (g)	1600	2200	4200	5200	4200	6200
Readability d (g)	0.01	0.01	0.01	0.01	0.1	0.1
Verification Interval e (g)	0.1	0.1	0.1	0.1	0.1	1
Class	II	II	II	II	II	II
Repeatability (sd.), ≤5% of Full Load (g)	0.008	0.008	0.008	0.008	0.08	0.08
Repeatability (sd.), 5% of Full Load to Full Range (g)	0.01	0.01	0.01	0.01	0.1	0.1
Linearity Deviation, Typical (g)	±0.006	±0.006	±0.006	±0.006	±0.06	±0.06
Linearity Deviation (g)	±0.02	±0.02	±0.02	±0.02	±0.2	±0.2
Stabilization Time Typical (s)	1	1	1	1	1	1
Sensitivity temperature drift (PPM/K)	±3	±3	±3	±3	±10	±10
Typical Minimum Weight USP (USP K=2,U=0.10%)	16 g	16 g	16 g	16 g	160 g	160 g
Optimized Min-Weight (g) (USP, u=0.10%, k=2) SRP ≤ 0.41d*	8.2 g	8.2 g	8.2 g	8.2 g	82 g	82 g
Units	g, kg, ct					
Applications	Basic Weighing, Parts Counting, Percent Weighing, Dynamic Weighing, Density Determination					
Platform Size (diameter, mm)	180	180	180	180	180	180
Span Calibration Points (g)	1000, 1500, 1600	1000, 2000	2000, 4000	3000, 5000	2000, 4000	5000, 6000
Linearity Calibration Points (g)	0, 800, 1600	0, 1000, 2000	0, 2000, 4000	0, 2500, 5000	0, 2000, 4000	0, 3000, 6000
Tare Range	To capacity by subtraction					
Power Supply	Power input: 100-240V ~ 200mA 50-60Hz 12-18VA Power output: 12 VDC 0.5A					
Assembled Dimensions (W x D x H) (mm)	209 x 321 x 98					
Communication	RS232					
Operating Temperature Range	Operating conditions for ordinary lab application: +10°C to 30°C (operability guaranteed between +5°C and 40°C).					
Storage Temperature Range	Humidity: maximum relative humidity 80% for temperatures up to 30°C, decreasing linearly to 50% relative humidity at 40°C					
Storage Conditions	-10°C to 60°C, humidity 10% to 90%, without condensation					
Net Weight	7.7 lb / 3.5 kg					
Shipping Weight	11 lb / 5 kg					
Shipping Dimensions (W x D x H) (mm)	550 x 385 x 291					

*SRP refers to the standard deviation for n replicate weightings (n ≥ 10).

9.2 Drawings and Dimensions

Fully assembled dimensions

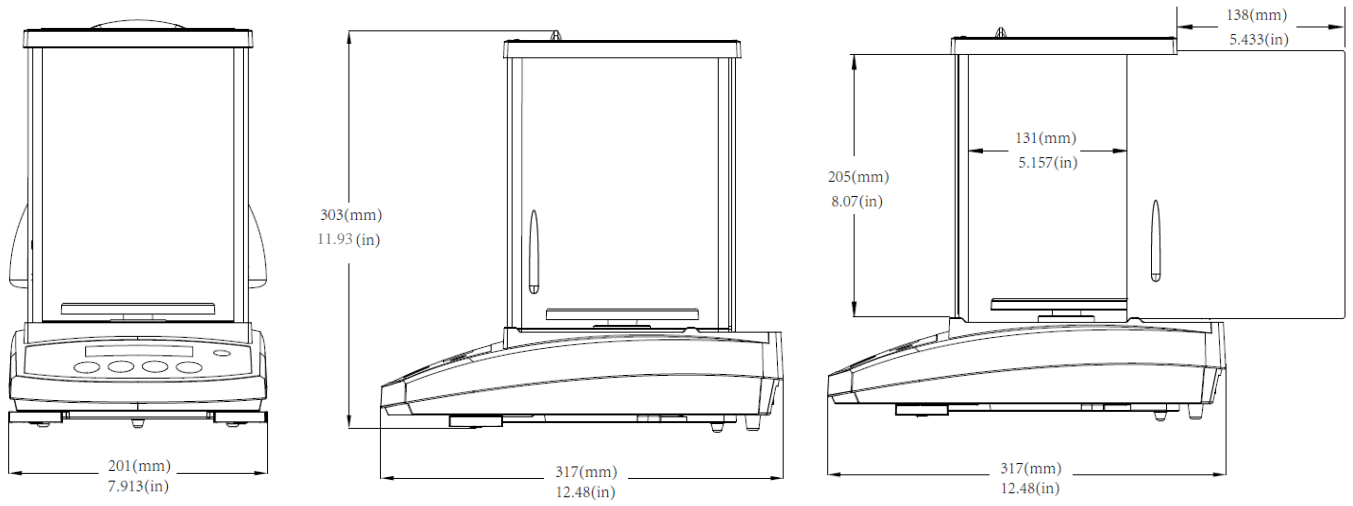

Figure 9-1 0.001 g / 0.0001 g model

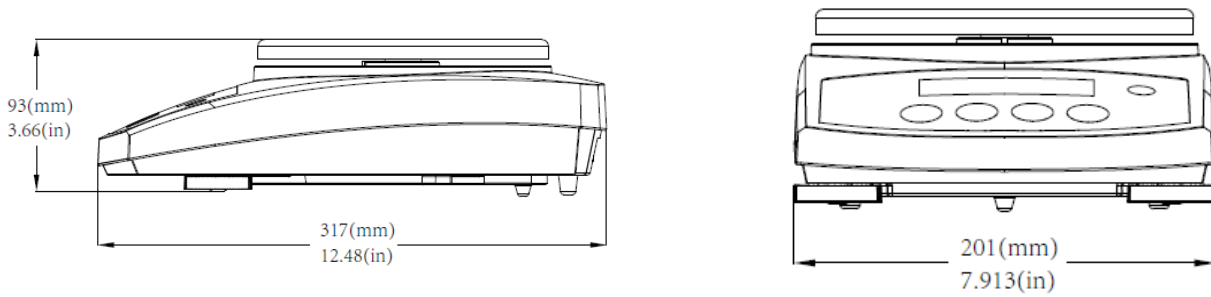

Figure 9-2 0.1 g / 0.01 g model

9.3 Accessories

DESCRIPTION	PART NUMBER
Auxiliary Display AD7-RS	30472064
Security Device	80850043
RS232 Cable (25 pin)	80500524
RS232 Cable (9 pin)	80500525
Dust Cover	30093334
In-use Cover	30372547
Printer SF40A	30064202 (EU); 30064203 (AM)
Power Adapter for Balance	46001724

9.4 Communication

9.4.1 Interface Commands

Commands listed in the following table will be acknowledged by the balance.

Command	Function
IP	Immediate Print of displayed weight (stable or unstable).
P	Print displayed weight (stable or unstable).
CP	Continuous Print.
SP	Print on Stability.
SLP	Set Auto Print to On Stability, allow non-zero displayed weight be printed.
SLZP	Set Auto Print to On Stability, allow both stable non-zero weight and stable zero reading to be printed.
xP	Set Auto Print to Interval Print, x = print interval (1-3600 sec), 0P disable the interval Print
0P	0P disable interval print, continuous print or print on stability
H	Enter Print Header Lines, the format is: H x "header string". Where x = line number 1 to 3, "header string" can be up to 24 alphanumeric characters. If no string in the command, "H x" will read the stored header x.
Z	Same as pressing Zero Key.
T	Same as pressing Tare Key.
xT***	Establish a preset Tare value in displayed unit. x = preset tare value. Sending 0T clears tare (if allowed).
PT	Prints Tare weight stored in memory.
PM	Print current application mode (weighing mode).
xM	Set current application mode to x. x depends on applications 1 – Weigh 2 – Count 3 – Percent
M	Scroll to the next enabled mode.
ON	Brings out of Standby
OFF	Goes to Standby.
C	Begin Span Calibration
IC	Begin Internal Calibration.

Command	Function
AC	Abort Calibration.
PSN	Print Serial Number.
PV	Print Version: print name, software revision and LFT On (if LFT is set On).
x#	Set Counting APW (x) in grams. (must have APW stored)
P#	Print Counting application APW.
x%	Set Percent application reference weight (x) in grams. (must have reference weight stored)
P%	Print Percent application reference weight.
PTIME	Print current time.
PDATE	Print current date.
xTIME	Set Time x format: hh:mm:ss
xDATE	Set Date x format: mm/dd/yyyy
xS	0 = print unstable data, 1 = print stable only
xRL	Enable or disable OK response to non-print commands: x=0 to disable, x=1 to enable.
xT	Pre-tare the container weight (x) in grams.

9.4.2 RS232 (DB9) Pin Connections

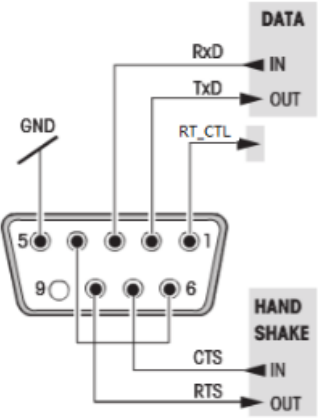
Diagram	Type	Description
	Interface type	Voltage interface conforming to EIA RS-232C/DIN 66020 (CCITT V24/V.28)
	Max. cable length	15 m
	Signal level	Output: +5 V ... +15 V (RL = 3 – 7kΩ) -5 V ... -15 V (RL = 3 - 7 kΩ) Input: +3 V ... +25 V -3 V ... -25 V
	Connector	Sub-D, 9-pole, female
	Operating mode	Full duplex
	Transmission mode	Bit-serial, asynchronous
	Transmission code	ASCII
	Baud rates	1200, 2400, 4800, 9600, 19200, 38400 (firmware selectable)
	Bits/parity	7-bit/even, 7-bit/odd, 7-bit/none, 8-bit/none (firmware selectable)
	Stop bits	Stop bit 1, 2
	Handshake	None, XON/XOFF, RTS/CTS (selectable)
	End-of-line	Not selectable

10. SOFTWARE UPDATES

Ohaus is continuously improving its balance software. To obtain the latest release, please contact your Authorized Ohaus Dealer or Ohaus Corporation.

11. COMPLIANCE

Compliance to the following standards is indicated by the corresponding mark on the product.

Mark	Standard
	This product complies with the EU Directives 2011/65/EU (RoHS), 2014/30/EU (EMC), 2014/35/EU (LVD) and 2014/31/EU (NAWI). The EU Declaration of Conformity is available online at www.ohaus.com/ce .
	This product complies with the EU Directive 2012/19/EU (WEEE). Please dispose of this product in accordance with local regulations at the collecting point specified for electrical and electronic equipment. For disposal instructions in Europe, refer to www.ohaus.com/wEEE .
	This product complies with the applicable statutory standards of the Restriction of the Use of Certain Hazardous Substances in Electrical and Electronic Equipment Regulations 2012, UK Electromagnetic Compatibility Regulations 2016, Electrical Equipment (Safety) Regulations 2016 and Non-Automatic Weighing Instruments Regulations 2016. The UK Declaration of Conformity is available online at www.ohaus.com/uk-declarations .
	EN 61326-1
	CAN/CSA-C22.2 No. 61010-1 UL Std. No. 61010-1

Important notice for PX/PXP/PJX/PR...M verified weighing instruments in the EU and UK

When the instrument is used in trade or a legally controlled application, it must be set up, verified and sealed in accordance with local weights and measures regulations. It is the responsibility of the purchaser to ensure that all pertinent legal requirements are met.

Weighing Instruments verified at the place of manufacture bear the following supplementary metrology marking on the descriptive plate.



Weighing Instruments to be verified in two stages have no supplementary metrology marking on the descriptive plate. The second stage of conformity assessment must be carried out by the applicable weights and measures authorities.

If national regulations limit the validity period of the verification, the user of the weighing instrument must strictly observe the re-verification period and inform the weights and measures authorities.

As verification requirements vary by jurisdiction, the purchaser should contact their local weights and measures office if they are not familiar with the requirements.

ISED Canada Compliance Statement:

This Class A digital apparatus complies with Canadian ICES-003.

ISO 9001 Registration

The management system governing the production of this product is ISO 9001 certified.

FCC Supplier Declaration of Conformity

Unintentional Radiator per 47CFR Part B
Trade Name: OHAUS CORPORATION
Model or Family identification: PX/PXP/PJX/PR

Issuing Party that Assembled the Product:

Ohaus Instruments (Changzhou) Co., Ltd.
2F, 22 Block, 538 West Hehai Road, Xinbei District, Changzhou
Jiangsu 213022
China
Phone: +86 519 85287270

Responsible Party – U.S. Contact Information:

Ohaus Corporation
7 Campus Drive, Suite 310
Parsippany, NJ 07054
United States
Phone: +1 973 377 9000
Web: www.ohaus.com

FCC Compliance Statement:

Note: This equipment has been tested and found to comply with the limits for a Class A digital device, pursuant to part 15 of the FCC Rules. These limits are designed to provide reasonable protection against harmful interference when the equipment is operated in a commercial environment. This equipment generates, uses, and can radiate radio frequency energy and, if not installed and used in accordance with the instruction manual, may cause harmful interference to radio communications. Operation of this equipment in a residential area is likely to cause harmful interference in which case the user will be required to correct the interference at his own expense. Changes or modifications not expressly approved by the party responsible for compliance could void the user's authority to operate the equipment.

LIMITED WARRANTY

Ohaus products are warranted against defects in materials and workmanship from the date of delivery through the duration of the warranty period. During the warranty period Ohaus will repair, or, at its option, replace any component(s) that proves to be defective at no charge, provided that the product is returned, freight prepaid, to Ohaus.

This warranty does not apply if the product has been damaged by accident or misuse, exposed to radioactive or corrosive materials, has foreign material penetrating to the inside of the product, or as a result of service or modification by other than Ohaus. In lieu of a properly returned warranty registration card, the warranty period shall begin on the date of shipment to the authorized dealer. No other express or implied warranty is given by Ohaus Corporation. Ohaus Corporation shall not be liable for any consequential damages.

As warranty legislation differs from state to state and country to country, please contact Ohaus or your local Ohaus dealer for further details.

Índice

1. INTRODUCCIÓN	3
1.1 Descripción	3
1.2 Funcionalidades	3
1.3 Definición de las señales y símbolos de advertencia	3
1.4 Precauciones de seguridad	3
2. INSTALACIÓN	4
2.1 Desembalaje	4
2.2 Seleccionar la ubicación	4
2.3 Nivelación	4
2.4 Conexión de la alimentación y aclimatación de la balanza	4
2.5 Conexión de la interfaz	5
2.6 Calibración inicial	5
3. FUNCIONAMIENTO	6
3.1 Descripción de la pantalla, pantalla de inicio	6
3.2 Funciones principales y Menú Principal	7
3.3 Descripción de piezas y características, modelos con cámara de pesaje	7
3.4 Descripción de piezas y características, modelos sin cámara de pesaje	7
4. APLICACIONES	8
4.1 Pesaje	8
4.2 Recuento de piezas	8
4.3 Pesaje porcentual	10
4.4 Características adicionales	12
5. CONFIGURACIÓN DEL MENÚ	13
5.1 Menú de navegación.....	13
5.1.1 Cambiar la configuración	13
5.2 Calibración	13
5.2.1 Submenú de calibración (modelos InCal)	13
5.2.2 Calibración interna (no aplicable a modelos ExCal)	14
5.2.3 Cal Adjust (no aplicable a modelos ExCal).....	14
5.2.4 Span Cal (Calibración de span)	14
5.2.5 Linearity Cal (Calibración de linealidad)	15
5.3 Configuración de la balanza	17
5.3.1 Filter Level (Nivel de filtrado)	17
5.3.2 AZT (cero automático)	17
5.3.3 Auto Tare (Tara automática).....	17
5.3.4 Graduations (Divisiones).....	18
5.3.5 Date Format (Formato de fecha)	18
5.3.6 Date Setup (Configuración de fecha).....	18
5.3.7 Time Format (Formato de hora).....	18
5.3.8 Time Setup (Configuración de hora).....	19
5.3.9 Brightness (Brillo).....	19
5.3.10 Auto Dim (Auto-oscurecer automático).....	19
5.3.11 Approved Mode (Modo aprobado)	19
5.4 Weighing Units (Unidades de pesaje)	20
5.5 RS232 Interface Setup (Configuración de la interfaz RS232)	21
5.5.1 Baud Rate (Velocidad en baudios)	21
5.5.2 Transmission (Transmisión).....	22
5.5.3 Handshake	22
5.6 Print Settings (Configuración de impresión)	22
5.6.1 Stable Only (Solo estable)	22
5.6.2 Numeric Only (Solo numérico).....	22
5.6.3 Single Header (Encabezado sencillo).....	23
5.6.4 Auto Print (Impresión automática)	23
5.6.5 Header (Encabezado).....	23
5.6.6 Date and Time (Fecha y hora)	24
5.6.7 Balance ID Id. De la báscula)	24

5.6.8	Balance Name (Nombre de la báscula)	24
5.6.9	User Name (Nombre de usuario)	24
5.6.10	Project Name (Nombre del proyecto)	24
5.6.11	Application Name (Nombre de la aplicación)	24
5.6.12	Result (Resultados)	24
5.6.13	Gross (Bruto)	24
5.6.14	Net (Neto)	25
5.6.15	Tare (Tara)	25
5.6.16	Signature Line (Línea de firma)	25
5.6.17	Line Feed (Avance de línea)	25
5.7	GLP	25
5.8	Factory reset (Restablecer a fábrica)	26
5.9	Lockout (Bloqueo)	26
6.	LEGAL PARA COMERCIO	27
6.1	Ajustes	27
6.2	Verificación	28
6.3	Sellado	28
7.	IMPRESIÓN	29
7.1	Conectar, configurar y probar la impresora / interfaz del ordenador	29
7.2	Formato de salida	30
7.3	Ejemplos de impresión	30
8.	MANTENIMIENTO	32
8.1	Calibración	32
8.2	Limpieza	32
8.3	Solución de problemas	32
8.4	Información de servicio	33
9.	DATOS TÉCNICOS	34
9.1	Especificaciones	34
9.2	Esquemas y dimensiones	42
9.3	Accesorios	43
9.4	Comunicación	43
9.4.1	Comandos de la interfaz	43
9.4.2	RS232 (DB9) Conexiones pin	44
10.	ACTUALIZACIONES DE SOFTWARE	44
11.	CONFORMIDAD	45

1. INTRODUCCIÓN

1.1 Descripción

La balanza PR es una balanza de precisión que le proporcionará años de servicio si se cuida correctamente.

Las balanzas PR están disponibles en capacidades desde 62 gramos a 6200 gramos.

1.2 Funcionalidades

Controles de operación: pantalla retroiluminada, con 3 aplicaciones y varias funciones de pesaje.



1.3 Definición de las señales y símbolos de advertencia

Los consejos de seguridad están marcados con palabras y símbolos de advertencia. Estos muestran advertencias y problemas de seguridad. Hacer caso omiso de las indicaciones de seguridad puede llevar a lesiones personales, daños al dispositivo, fallos de funcionamiento y resultados falsos.

ADVERTENCIA Situaciones peligrosas con riesgo medio, que pueden provocar la muerte o lesiones graves si no se evitan.

PRECAUCIÓN Situaciones peligrosas con riesgo bajo, que pueden provocar daños en el dispositivo o a la propiedad, pérdida de datos, o lesiones graves si no se evitan.

Atención Información importante sobre el producto.

Nota Información útil sobre el producto.

Símbolos de advertencia



Peligro general



Peligro descarga eléctrica



Corriente alterna



Corriente continua

1.4 Precauciones de seguridad



PRECAUCIÓN: lea todas las advertencias de seguridad antes de instalar, hacer conexiones o realizar el mantenimiento de este equipo. El incumplimiento de las instrucciones podría resultar en lesiones personales y/o daños materiales. Conserve todas las instrucciones para futura referencia.

- Compruebe que el rango de voltaje de entrada del adaptador de CA y el tipo de enchufe son compatibles con la red eléctrica de corriente alterna local.
- Asegúrese de que el cable de alimentación no represente un posible obstáculo o riesgo de tropezarse.
- No coloque la balanza de tal manera que sea difícil llegar a la conexión eléctrica.
- Utilice la balanza solo en interiores. No utilice la unidad en entornos peligrosos o en lugares inestables.
- Opere la unidad solamente bajo las condiciones ambientales especificadas en estas instrucciones.
- No deje caer cargas sobre el plato.
- Utilice la balanza solo en lugares secos.
- Desconecte el equipo de la fuente de alimentación durante su limpieza.
- Utilice accesorios y periféricos aprobados.
- Cualquier reparación y servicio debe ser realizado solo por personal autorizado.

2. INSTALACIÓN

2.1 Desembalaje

Extraiga con cuidado la balanza PR y cada uno de sus componentes del paquete. Los componentes incluidos varían dependiendo del modelo de balanza. Conserve el embalaje para asegurar un almacenamiento y transporte seguro. Lea el manual antes de instalar y utilizar la balanza PR para evitar un manejo incorrecto.

Componentes incluidos:

- Balanza
- Adaptador de corriente + enchufe
- Plato de acero inoxidable
- Soporte para el plato (para los modelos 0.1 g / 0.01 g)
- Tarjeta de garantía

2.2 Seleccionar la ubicación

Evite fuentes de calor, cambios rápidos de temperatura, corrientes de aire o vibraciones excesivas. Deje espacio suficiente.

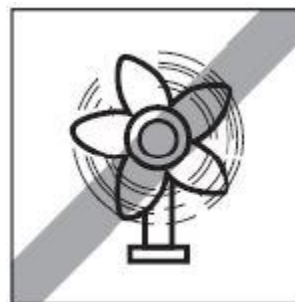
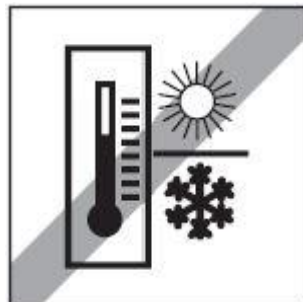

2.3 Nivelación

Asegúrese de que la balanza está nivelada antes de su uso o después de cambiar su ubicación.

La balanza PR tiene un nivel de burbuja en una pequeña ventana redonda junto a la pantalla.

Para nivelar la balanza, ajuste los 2 pies de nivelación hasta que la burbuja esté centrada en el círculo.

Consulte el dibujo de la derecha para ajustar la nivelación.

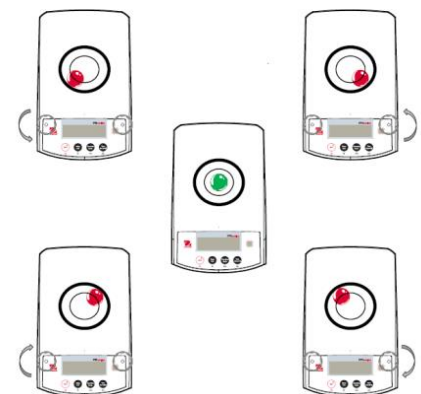

2.4 Conexión de la alimentación y aclimatación de la balanza

Conecte el conector de salida de CC a la toma de corriente en la parte posterior de la balanza. A continuación, conecte el enchufe del adaptador de CA a una toma de corriente adecuada.

Aclimatación

Se recomienda no utilizar la balanza hasta que la unidad se haya aclimatado al entorno durante un determinado período de tiempo. En el caso de balanza con precisión por encima de 0,1 mg, el tiempo de pre-aclimatación debe ser de 1,5 horas; en el caso de balanza con una precisión de 1 mg, el tiempo de aclimatación debe ser de un mínimo de 0,5 horas.

2.5 Conexión de la interfaz

La balanza PR balance tiene un puerto RS232.

Utilice el puerto RS-232 para conectar con un ordenador o una impresora mediante un cable serie estándar (directo).

Conexiones de interfaz en la parte posterior de la balanza



RS232

RS232: utilizado para conectar a ordenador o impresora

Nota: consulte la sección «Impresión» para la Conexión, Configuración y Prueba de la impresora / interfaz del ordenador.

2.6 Calibración inicial

Al instalar la balanza PR por primera vez, o cuando se cambia de lugar, debe calibrarse para asegurar resultados de pesaje exactos. Las balanzas PR se clasifican en dos categorías, modelos InCal y modelos ExCal. Los modelos InCal tienen un mecanismo de calibración integrado que puede calibrar la balanza de forma automática y no requiere el uso de pesos de calibración externos. Si se prefiere, los modelos InCal también se pueden calibrar manualmente con pesos externos. Los modelos ExCal se calibran con pesos externos. Asegúrese de tener disponible los pesos de calibración apropiados antes de comenzar la calibración.





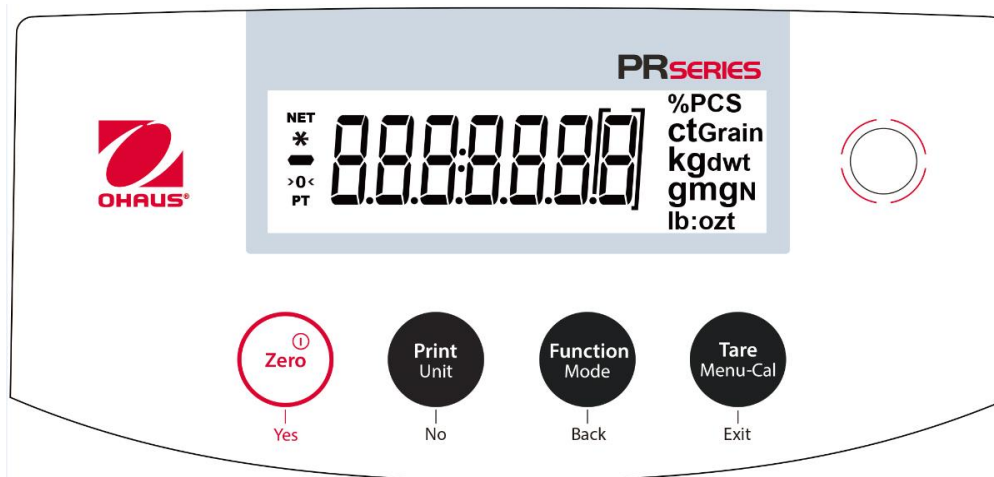

3. FUNCIONAMIENTO

3.1 Descripción de la pantalla, pantalla de inicio

CONTROLES



FUNCIONES DE CONTROL

Botón	 Yes	 No	 Back	 Exit
Función primaria (Pulsación rápida) 	On / Zero <ul style="list-style-type: none"> Si el indicador está en Off (apagado), se enciende el indicador. Si el indicador está en On (activado), se ajusta en cero. 	Print <ul style="list-style-type: none"> Envía el valor mostrado a la interfaz serial. 	Function <ul style="list-style-type: none"> La operación depende del modo de aplicación. 	Tare <ul style="list-style-type: none"> Realiza la operación de tara.
Función secundaria (Pulsar y mantener) 	Off <ul style="list-style-type: none"> Ajusta a cero el valor actual. 	Unit <ul style="list-style-type: none"> Cambia las unidades de pesaje. 	Mode <ul style="list-style-type: none"> Cambia el modo de aplicación. 	Menu-Cal <ul style="list-style-type: none"> Entra en el menú principal. La calibración es el primer submenú. Muestra el valor de tara predeterminado.
Función de menú (Pulsación rápida) 	Yes <ul style="list-style-type: none"> Acepta la configuración actual (intermitente) en la pantalla. 	No <ul style="list-style-type: none"> Rechaza la configuración actual (intermitente) en la pantalla. Incrementa un valor introducido. 	Back <ul style="list-style-type: none"> Vuelve a la opción de menú anterior. Disminuye un valor introducido. 	Exit <ul style="list-style-type: none"> Sale inmediatamente del submenú. Aborta una calibración en curso.

PANTALLA DE LA APLICACIÓN PRINCIPAL



3.2 Funciones principales y Menú Principal

- Pesaje:** Pulse el botón **Zero** para ajustar la pantalla a cero. Coloque un objeto en el plato. La pantalla indica el peso bruto.
- Tarar:** Sin carga en el plato, pulse **Zero** para ajustar la pantalla a cero. Coloque un recipiente vacío en el plato y pulse **Tare**. Añada objetos al recipiente para ver su peso. Una vez retirados el recipiente y los objetos, la carga se mostrará como un número negativo. Pulse **Tare** para borrar.
- Cero:** Pulse **Zero** para ajustar la balanza a cero.

3.3 Descripción de piezas y características, modelos con cámara de pesaje

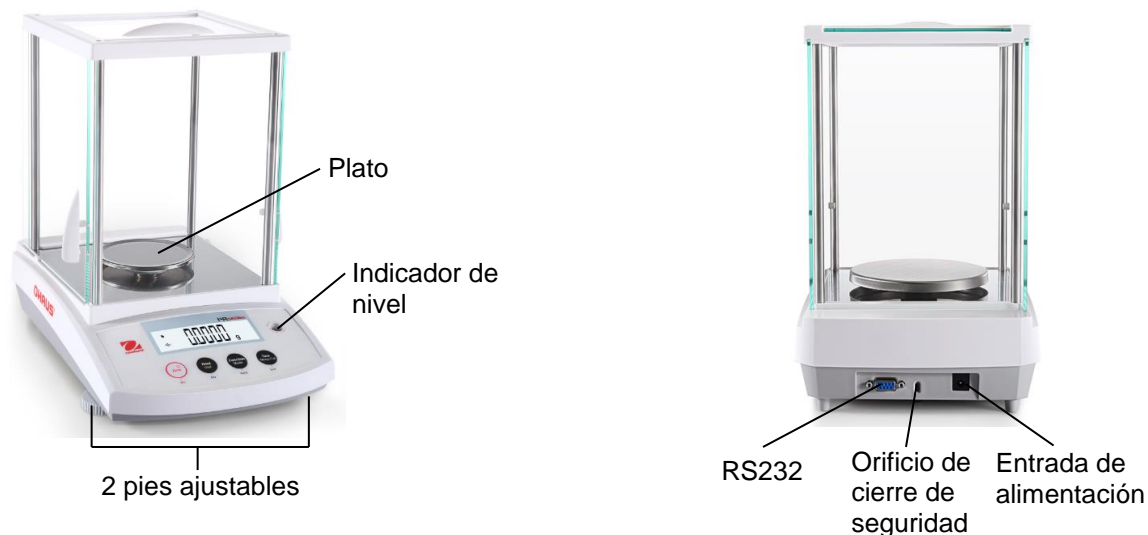

3.4 Descripción de piezas y características, modelos sin cámara de pesaje

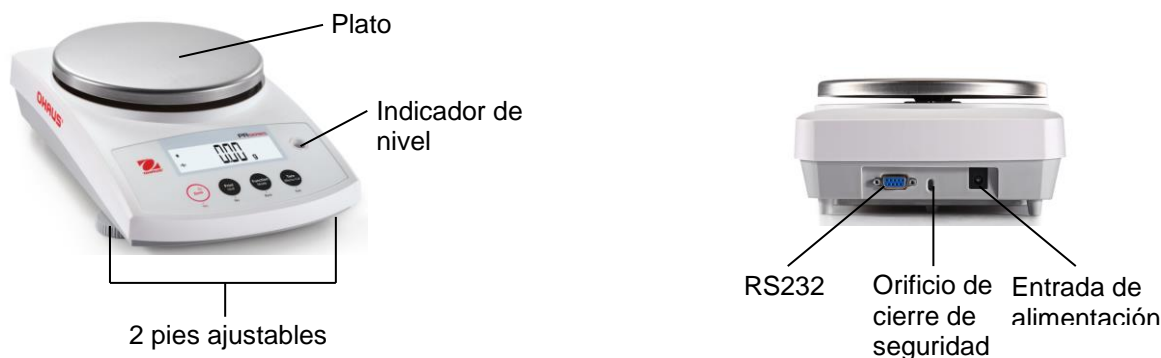

4. APLICACIONES

La balanza PR puede funcionar en 3 modos de aplicación con una pulsación larga del botón **Function / Mode**.

4.1 Pesaje

Nota: antes de utilizar cualquier aplicación, asegúrese de que la balanza está nivelada y calibrada.

Utilice esta aplicación para determinar el peso de los objetos en la unidad de medida seleccionada.

Pesaje

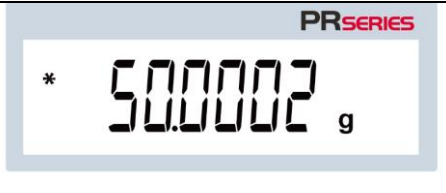
<ol style="list-style-type: none"> 1. Pulse Tare o Zero si es necesario para comenzar. 2. Pulse y mantenga pulsado el botón Function / Mode para seleccionar «LWE 10H» (esta es la aplicación predeterminada). 	
<ol style="list-style-type: none"> 3. Coloque objetos sobre el plato para mostrar su peso. Cuando la lectura sea estable, aparecerá el símbolo *. 4. El valor resultante se visualiza en la unidad de medida actual. 	

Configuración del elemento

Para ver o ajustar la configuración actual.



- **Unidades de pesaje:** cambia la unidad indicada. Vea la Sección 5.4 para consultar los procesos detallados.
- **Nivel de filtrado:** cambia el nivel de filtrado. Vea la Sección 5.3.2 para obtener más información.
- **Datos GLP:** vea la Sección 5.7 para obtener más información.
- **Configuración de impresión:** cambia la configuración de impresión. Vea la Sección 7 para obtener más información.

4.2 Recuento de piezas

Nota: antes de utilizar cualquier aplicación, asegúrese de que la balanza está nivelada y calibrada. El peso mínimo de la pieza no debe ser inferior a 0,1 d. En el modo LFT, el peso mínimo de la pieza es 3e, el tamaño mínimo de la muestra es 10.

Utilice esta aplicación para contar las muestras de peso uniforme.

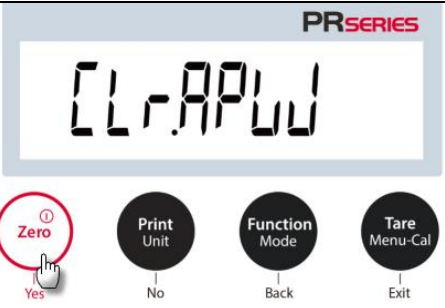
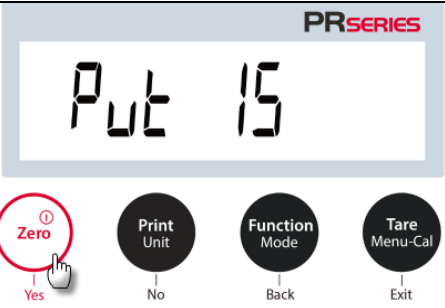
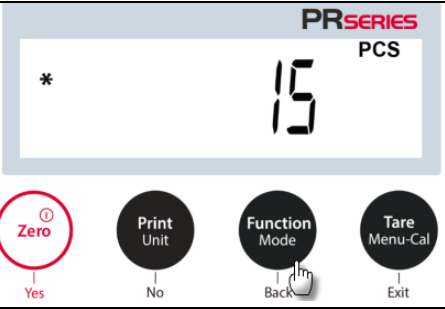
Recuento de piezas

<ol style="list-style-type: none"> 1. Pulse Tare o Zero si es necesario para comenzar. 2. Pulse y mantenga pulsado el botón Function / Mode hasta que la palabra «Count» aparezca en la pantalla. 	 <p>The display shows 'Count' in large characters. Below the display are four buttons: 'Zero' (circled in red), 'Print Unit', 'Function Mode' (with a hand icon pointing to it), and 'Tare Menu-Cal'.</p>
<ol style="list-style-type: none"> 3. Después de confirmarlo pulsando Yes, aparecerá en la pantalla el mensaje «CLF.APW». 	 <p>The display shows 'CLF.APW' in large characters. Below the display are four buttons: 'Zero' (circled in red with a hand icon pointing to it), 'Print Unit', 'Function Mode', and 'Tare Menu-Cal'.</p>
<ol style="list-style-type: none"> 4. Pulse Yes, y aparecerá el mensaje «Put 15» con el numeral 15 (predeterminado) parpadeando. El usuario puede pulsar No o Yes para aumentar o disminuir el valor. Por ejemplo, para aumentar el valor a 15, pulse Yes. A continuación, «Put» y «15» parpadean de manera simultánea. 	 <p>The display shows 'Put 15' in large characters. Below the display are four buttons: 'Zero' (circled in red with a hand icon pointing to it), 'Print Unit', 'Function Mode', and 'Tare Menu-Cal'.</p>
<ol style="list-style-type: none"> 4. Coloque 15 muestras en el plato. Pulse el botón Function / Mode de modo que el peso de las 15 muestras se utiliza para establecer el peso medio de las piezas (APW). La pantalla mostrará 15 piezas. 	 <p>The display shows '* 15 PCS' in large characters. Below the display are four buttons: 'Zero' (circled in red), 'Print Unit', 'Function Mode' (with a hand icon pointing to it), and 'Tare Menu-Cal'.</p>
<ol style="list-style-type: none"> 5. Retire las 15 muestras del plato y coloque sobre él muestras adicionales. Se mostrará en la pantalla el número correspondiente de piezas. 	 <p>The display shows '* 20 PCS' in large characters. Below the display are four buttons: 'Zero' (circled in red), 'Print Unit', 'Function Mode' (with a hand icon pointing to it), and 'Tare Menu-Cal'.</p>
<ol style="list-style-type: none"> 6. Para ver el peso total o el número de piezas de los objetos, pulse el botón Function / Mode. 	 <p>The display shows '* 40.0000 g' in large characters. Below the display are four buttons: 'Zero' (circled in red), 'Print Unit', 'Function Mode' (with a hand icon pointing to it), and 'Tare Menu-Cal'.</p>

Configuración del elemento

Para ver o ajustar la configuración actual.

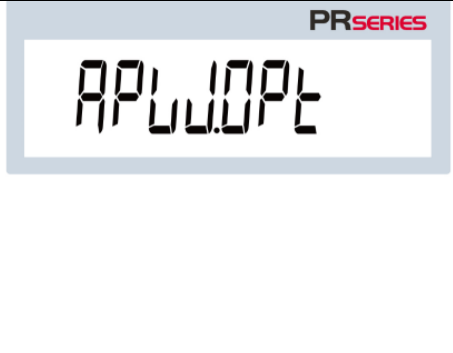
<p>Muestra: el tamaño de muestra varía de 1 a 100. El valor predeterminado es 10.</p> <p>Nota: si es necesario mantener el APW de la última operación de recuento de piezas, el usuario puede pulsar No cuando la pantalla muestra el mensaje «CLr.APW» (borra el peso medio de la pieza). Coloque objetos adicionales en el plato para ver el correspondiente número de piezas.</p>	
<p>Optimización del APW: Mejora la exactitud del recuento recalculando el peso de la pieza de forma automática a medida que se añaden más piezas.</p> <p>La optimización del APW se produce solo cuando el número de piezas añadidas al plato es entre una y tres veces el número de las que ya están en él.</p> <p>Configuración de impresión: Cambia la configuración de impresión. Vea la Sección 7 para obtener más información.</p>	

4.3 Pesaje porcentual







Nota: antes de utilizar cualquier aplicación, asegúrese de que la balanza está nivelada y calibrada.

Utilice pesaje porcentual para mostrar el peso de un objeto de prueba como porcentaje de una muestra de referencia preestablecida.

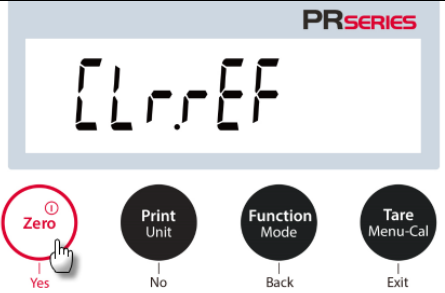
Se muestra el peso predeterminado (o último) de referencia.

Pesaje porcentual

<p>1. Mantenga pulsado el botón Function / Mode hasta que aparezca en pantalla el mensaje «PERCENT».</p>	
---	--

<p>2. Después de confirmarlo pulsando Yes, aparecerá en la pantalla el mensaje «CLr.rEF» (borrar referencia).</p>	 <p>The screenshot shows the PR Series balance display with the message 'CLr.rEF'. Below the display are four buttons: 'Zero' (circled in red), 'Print Unit', 'Function Mode', and 'Tare Menu-Cal'. A mouse cursor is pointing at the 'Zero' button, which is labeled 'Yes' below it. The other buttons are labeled 'No', 'Back', and 'Exit' respectively.</p>
<p>3. Pulse Yes, se mostrará el mensaje «PULr.rEF» (poner el peso de referencia).</p>	 <p>The screenshot shows the PR Series balance display with the message 'PULr.rEF'. Below the display are four buttons: 'Zero' (circled in red), 'Print Unit', 'Function Mode', and 'Tare Menu-Cal'. A mouse cursor is pointing at the 'Zero' button, which is labeled 'Yes' below it. The other buttons are labeled 'No', 'Back', and 'Exit' respectively.</p>
<p>4. Coloque la muestra de referencia en el plato para mostrar su peso. Cuando la lectura sea estable, aparecerá el símbolo *.</p> <p>5. Pulse el botón Function / Mode para guardar en la memoria el peso de las muestras de referencia. La pantalla mostrará «100 %».</p>	 <p>The screenshot shows the PR Series balance display with the message '* 100.00000 %'. Below the display are four buttons: 'Zero', 'Print Unit', 'Function Mode', and 'Tare Menu-Cal'. A mouse cursor is pointing at the 'Function Mode' button, which is labeled 'Back' below it. The other buttons are labeled 'Yes', 'No', and 'Exit' respectively.</p>
<p>6. Retire la muestra de referencia, y coloque el objeto de prueba en el plato. La relación del objeto de prueba al peso de la muestra de referencia se muestra como un porcentaje.</p>	 <p>The screenshot shows the PR Series balance display with the message '* 50.00000 %'. Below the display are four buttons: 'Zero', 'Print Unit', 'Function Mode', and 'Tare Menu-Cal'. A mouse cursor is pointing at the 'Function Mode' button, which is labeled 'Back' below it. The other buttons are labeled 'Yes', 'No', and 'Exit' respectively.</p>
<p>7. Para ver el peso de la muestra de referencia o el porcentaje del peso del objeto de prueba al peso de la muestra de referencia, pulse el botón Function / Mode.</p>	 <p>The screenshot shows the PR Series balance display with the message '100.00000 g'. Below the display are four buttons: 'Zero', 'Print Unit', 'Function Mode', and 'Tare Menu-Cal'. A mouse cursor is pointing at the 'Function Mode' button, which is labeled 'Back' below it. The other buttons are labeled 'Yes', 'No', and 'Exit' respectively.</p>
<p>8. Para establecer un nuevo peso de muestra de referencia, mantenga pulsado el botón Function / Mode y repita los pasos descritos anteriormente.</p>	 <p>The screenshot shows the PR Series balance display with the message 'PERCENT'. Below the display are four buttons: 'Zero', 'Print Unit', 'Function Mode', and 'Tare Menu-Cal'. A mouse cursor is pointing at the 'Function Mode' button, which is labeled 'Back' below it. The other buttons are labeled 'Yes', 'No', and 'Exit' respectively.</p>

Configuración del elemento

Nota: si es necesario mantener el peso de referencia de la última operación de pesaje porcentual, pulse **No** cuando aparezca el mensaje «Lr.rEF» (borrar referencia).

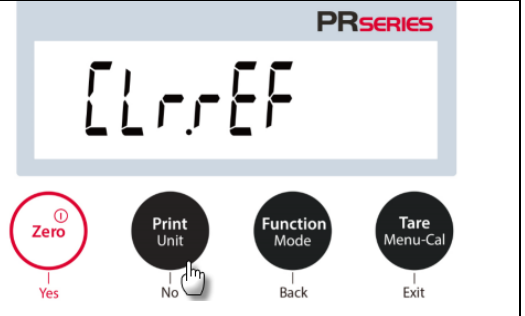

Configuración de impresión: cambiar la configuración de impresión. Vea la Sección 7 para obtener más información.

4.4 Características adicionales

Pesaje por debajo

Nota: asegúrese de que la balanza está nivelada y calibrada.

La balanza PR está equipada con un gancho inferior para permitir el pesaje por debajo (como se muestra a continuación).

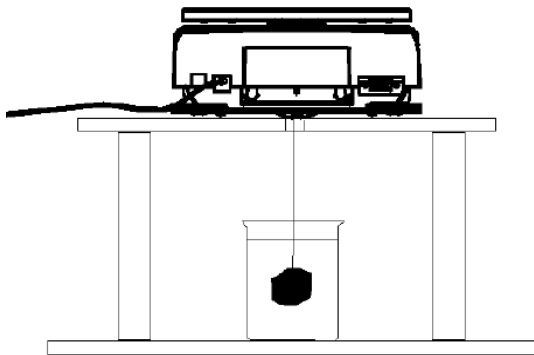

Antes de dar la vuelta a la balanza, quite el plato y los componentes de la cámara de pesaje (si procede) para evitar daños. No coloque la balanza en el cono de soporte del plato o las clavijas de la celda de carga.

Para utilizar esta característica, corte la alimentación a la balanza y, a continuación, retire la cubierta protectora para la abertura del pesaje por debajo.

Encienda la balanza, y utilice una cuerda o alambre para fijar los elementos a pesar.

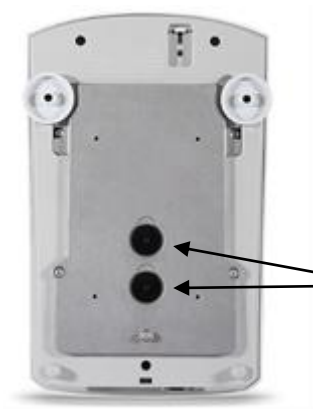

Cubierta protectora del pesaje por debajo



Gancho del pesaje por debajo

5. CONFIGURACIÓN DEL MENÚ

5.1 Menú de navegación

Calibration	Setup	Unit	RS232	Print	GLP	Reset	Lock
InCal	Filter Level	Gram	Baud Rate	Stable Only	Header 1	Reset All	Calibration
Cal Adjust	AZT	Kilogram	Parity	Numeric Only	Header 2		Setup
Span Cal	Auto Tare	Milligram	Handshake	Single Header	Header 3		RS232
Linearity Cal	Graduations	Carat		Auto Print	Balance Name		Print
	Date Format	Pound		Header	User Name		GLP
	Date Setting	Ounce		Date and Time	Project Name		Reset
	Time Format	Ounce Troy		Balance ID			
	Time Setting	Penny Weight *		Balance Name			
	Brightness	Newton		User Name			
	Auto Dim	Taiwan Tael		Project Name			
	LFT	Custom 1		Application Name			
		Grain		Result			
				Gross Weight			
			Net Weight				
			Tare Weight				
			Signature Line				
			Line Feed				

* Penny weight is not available for NTEP model.

Nota: las balanzas PR se clasifican en modelos InCal y modelos ExCal.

5.1.1 Cambiar la configuración

Para cambiar la configuración del menú, desplácese hasta el ajuste que desea modificar con los siguientes pasos:

Entrar al menú

Mantenga pulsado el botón **Menú** para acceder a él.

Seleccionar el submenú

Pulse **No** para navegar ente submenús, y pulse **Yes** para entrar en el submenú.

Seleccionar el elemento del menú

Pulse **No** para navegar entre los elementos del menú, y pulse **Yes** para seleccionar el elemento de menú que se muestra.

5.2 Calibración

Las balanzas PR ofrecen tres métodos de calibración: Calibración interna (solo en modelos InCal), calibración de span o alcance (Span Cal), y calibración de linealidad (Linearity Cal).

Atención: no perturbe la balanza durante la calibración.

5.2.1 Submenú de calibración (modelos InCal)

Nota: los modelos ExCal solo cuentan con calibración de span y calibración de linealidad.

5.2.2 Calibración interna (no aplicable a modelos ExCal)

La calibración se logra utilizando pesos de calibración internos. La calibración interna puede realizarse en cualquier momento, siempre y cuando la balanza esté a temperatura de funcionamiento y nivelada. Para realizar la calibración interna es necesario que la balanza esté encendida y sin carga en el plato. Pulse el botón **Tara / Menu-Cal** para entrar en la configuración de calibración interna.

Alternativamente, pulse el botón **Tare / Menu-Cal** y seleccione **InCAL** para iniciar la calibración interna.

Establecer la funcionalidad de calibración interna.		InCAL calibración interna
On = Activado Off = Desactivado. InCAL = iniciar la calibración interna		
On Activado	Off Desactivado	InCAL calibración interna

La pantalla muestra el estado, y pulse cualquier botón para volver a la pantalla anterior.

5.2.3 Cal Adjust (no aplicable a modelos ExCal)

Utilice este método de calibración para ajustar el efecto de la calibración interna. El ajuste de calibración puede utilizarse para ajustar los resultados de la calibración interna por ± 100 divisiones.

Nota: antes de hacer un ajuste de calibración, realice una calibración interna. Para comprobar si es necesario un ajuste, coloque en el plato un peso de prueba igual al **valor de calibración de span**, y observe la diferencia (en divisiones) entre el valor nominal del peso y la lectura real de la balanza. Si la diferencia está dentro de ± 1 división, no se requiere ajustar la calibración. Si la diferencia excede ± 1 división, se recomienda ajustar la calibración.

Ejemplo:

Lectura prevista de peso:	200.000 (valor total de la prueba)
Lectura real de peso:	200.014
Diferencia en gramos:	- 0.014
Diferencia en la división:	- 14 (valor InCal Adjust)

Para realizar un ajuste de calibración, seleccione «InCal Adjustment» en el menú de calibración; introduzca el valor (divisiones positivas o negativas) para que coincida con la diferencia observada anteriormente en el proceso.

Vuelva a calibrar utilizando la calibración interna. Después de la calibración, coloque el peso de prueba en el plato y compruebe que el valor coincide con el valor mostrado. En caso contrario, repita el procedimiento hasta que la lectura de la calibración interna coincida con el peso de prueba.





Una vez completado, la balanza almacena el valor de ajuste y la pantalla regresa a la aplicación actual.

5.2.4 Span Cal (Calibración de span)

La calibración de span utiliza dos puntos de calibración, uno a **carga cero** y el otro a **carga completa especificada** (span). Para obtener información detallada sobre pesos de calibración, consulte los «Puntos de calibración de span» en las tablas que encontrará en la sección 9 bajo ESPECIFICACIONES.

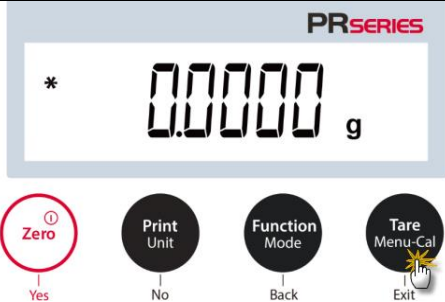
Para realizar la calibración de span es necesario que la balanza esté encendida y sin carga en el plato. En la pantalla se muestran los valores de calibración adicionales a utilizar. La mayor precisión se consigue utilizando el peso más cercano al valor de span.

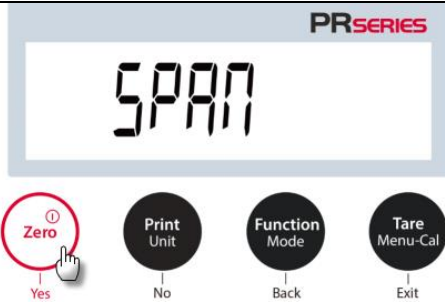
Pasos para la calibración de span

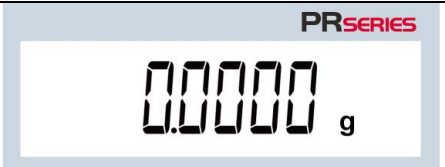
<p>1. Mantenga pulsado el botón Tare / Menu-Cal para mostrar el menú de calibración.</p>	
<p>2. Pulse Yes para entrar en el menú de calibración.</p>	
<p>3. Para cambiar el modo de calibración, pulse No hasta que aparezca «SPAN» (calibración de span) en la pantalla.</p>	
<p>4. El valor de los pesos de calibración aparecerá en la pantalla. Cuando la pantalla muestre 200.0000 g, coloque pesos de 200 g en el plato. Para cambiar el punto de calibración a la mitad de la capacidad (es decir, 100 g), pulse el botón Function / Mode. Si se muestra 0,0000 g, retire la masa.</p>	
<p>5. Una vez que la calibración de span se ha completado con éxito, la pantalla mostrará «CALdone». Pulse cualquier botón para volver a la pantalla anterior.</p>	
<p>6. Retire el peso, y la lectura se pondrá a cero.</p>	

5.2.5 Linearity Cal (Calibración de linealidad)

La calibración de linealidad utiliza tres puntos de calibración, uno a carga cero y los otros a carga especificada.

Sin carga en el plato, pulse Linearity Calibration (calibración de linealidad) para iniciar el proceso.

La balanza captura el punto cero y le solicitará el siguiente peso.

Siga las instrucciones en la pantalla hasta que se complete la calibración.

Pasos para la calibración de linealidad

<p>1. Mantenga pulsado el botón Tare / Menu-Cal para mostrar el menú de calibración.</p>	
<p>2. Pulse Yes para entrar en el menú de calibración.</p>	
<p>3. Para cambiar el modo de calibración, pulse No hasta que la pantalla muestre «L inEAR» (calibración de span).</p>	
<p>4. El valor de los pesos de calibración aparecerá en la pantalla. Cuando la pantalla muestre «100.00000 g», coloque pesos de 100 g en el plato.</p>	
<p>5. Retire el peso de 100 g del plato. Pasado un tiempo, la pantalla mostrará «200.00000 g». Coloque en el plato pesos de 200 g.</p>	
<p>6. Una vez que la calibración de linealidad se ha completado con éxito, la pantalla mostrará «CALdone». Pulse cualquier botón para volver a la pantalla anterior.</p>	
<p>7. Retire el peso, y la lectura se pondrá a cero.</p>	

5.3 Configuración de la balanza

Acceda a este menú para personalizar la funcionalidad de la unidad.

Nota: la configuración predeterminada de fábrica se muestra en **negrita**.

5.3.1 Filter Level (Nivel de filtrado)

Configura la cantidad de filtrado de señales.

F I L T E R

Low (Bajo) = tiempo de estabilización más rápido con menos estabilidad.

Medium (Medio) = estabilización en tiempo normal con estabilidad normal.

High (Alto) = tiempo de estabilización más lento con más estabilidad.

Low

Bajo

Med

Medio

HIGH

Alto

5.3.2 AZT (cero automático)

Configura la funcionalidad de cero automático.

A Z T

Cero automático

Off = desactivado.

0,5d = la pantalla mantiene el cero hasta una desviación de 0,5 graduaciones por segundo.

1d = la pantalla mantiene el cero hasta una derivación de 1 graduación por segundo.

3d = la pantalla mantiene el cero hasta una derivación de 3 graduaciones por segundo.

0.5 d

0.5 d

1 d

1 d

3 d

3 d

5.3.3 Auto Tare (Tara automática)

Configura la tara automática.

Cuando esta función está activada, el primer objeto colocado sobre el plato será considerado como un recipiente y la balanza señalará la tara automáticamente.

Off = desactivado.

On = activado.

A.T.A.R.E

Tara automática

OFF

Desactivado

ON

Activado



5.3.4 Graduations (Divisiones)

Configura la legibilidad indicada de la balanza.

1 división = legibilidad estándar.

10 divisiones = la legibilidad se incrementa por 10.



Por ejemplo, si la legibilidad estándar es de 0,01 g, seleccionar 10 divisiones resultará en una lectura de 0,1 g.

		
Graduación	1 División	10 Divisiones

5.3.5 Date Format (Formato de fecha)

Configura el formato de fecha actual.

Formato de fecha:
AA/MM/DD
MM/DD/AA
DD/MM/AA



	
Formato de fecha	DD/MM/AAAA
	
DD/MM/AAAA	AAAA/MM/DD

5.3.6 Date Setup (Configuración de fecha)

Configura la fecha actual al formato deseado.

Para configurar la fecha actual, pulse **No** o **Yes** para aumentar o disminuir el valor.

Por ejemplo, si la fecha actual es 22 de junio de 2017
MM/DD/AA: 06.22.17
DD/MM/AA: 22.06.17
AA/MM/DD: 17.06.22

Fecha

5.3.7 Time Format (Formato de hora)

Configura el formato de hora.

Formato de hora:
24 hr
12 hr

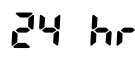
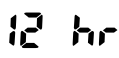
		
Formato de hora	24 hr	12 hr

5.3.8 Time Setup (Configuración de hora)

Configura la hora actual al formato deseado.	t .77E
Para configurar la hora actual, pulse No o Yes para aumentar o disminuir el valor.	08.00.00

5.3.9 Brightness (Brillo)

Ajusta el brillo de la pantalla.	br .9ht	77Ed
Medio Alto Bajo	Brillo	Medium
	HIGH	Low
	Alto	Low

5.3.10 Auto Dim (Auto-oscurer automático)

Configura si la balanza apaga automáticamente la retroiluminación de la pantalla.	Aut.d .77	
Off = desactivado. 10 minutos = oscurecer si no hay movimiento durante 10 minutos. 20 minutos = oscurecer si no hay movimiento durante 20 minutos. 30 minutos = oscurecer si no hay movimiento durante 30 minutos.		
10 .77 .t	20 .77 .t	30 .77 .t
10 min	20 min	30 min

5.3.11 Approved Mode (Modo aprobado)

Utilice este menú para configurar el estado legal para comercio.	LFE
OFF = funcionamiento estándar. ON = el funcionamiento cumple con las normas legales de metrología.	

Para modelos PRxxxN:

Utilice este menú para configurar el estado legal para comercio.	LFE
OFF = funcionamiento estándar. ON 1d= el funcionamiento cumple con las normas legales de metrología, e=1d. ON 10d= el funcionamiento cumple con las normas legales de metrología, e=10d.	

Nota: cuando el modo aprobado está activado, los ajustes del menú se ven afectados de la siguiente manera:

Menú de calibración:

- Para los modelos InCal, solo está disponible la calibración interna. Todas las demás funciones están ocultas.

Menú de configuración de la balanza:

- El nivel de filtrado está bloqueado en el valor actual.
- Cero automático se limita a 0.5 divisiones y a «desactivado». El ajuste seleccionado está bloqueado.
- La tara automática está bloqueada en el valor actual.
- Las graduaciones se fuerzan a 1 división y el elemento de menú está oculto.

Menú de comunicación (Comunicación->Configuración de impresión->Impresión):

- Solo peso estable está bloqueado en «activado».
- Solo valor numérico está bloqueado en «desactivado».

Menú de comunicación (Comunicación->Configuración de impresión->Impresión automática):

- La selección de modos de impresión automática se limitan a desactivado (Off), activado cuando estable (On Stability), e intervalo (Interval). Continua no está disponible.

Menú de bloqueo:

- El menú está oculto

5.4 Weighing Units (Unidades de pesaje)

Acceda a este submenú para activar las unidades de medida que desea.



Las balanzas PR proporcionan una selección de 12 unidades, las cuales vienen todas ajustadas en «activado» por defecto.

Nota: debido a las leyes nacionales, la balanza podría no incluir algunas de las unidades de medida a continuación.

NTEP-Modell: El menú de unidades se utiliza para habilitar o inhabilitar una unidad de peso específica. (SET ON, SET OFF).

Unidad	Pantalla
Gramo	g
Kilogramo	kg
Miligramo	mg
Quilate	cr
Libra	lb
Onza	oz
Onza troy	ozt
Penny weight	dwt
Newton	N
TW Tael	t
Custom 1	C
Grain	GN

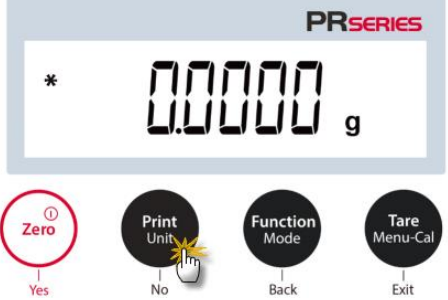
Cambiar las unidades de pesaje

<p>1. Mantenga pulsado el botón Print / Unit hasta que <i>Unit Menu</i> (menú de unidades) aparezca en pantalla.</p>	
<p>2. La unidad por defecto es el gramo (g). Para cambiar la unidad, pulse No para avanzar a la siguiente unidad.</p>	
<p>3. Pulse YES para fijar la unidad indicada como unidad de pesaje.</p>	

5.5 RS232 Interface Setup (Configuración de la interfaz RS232)

<p>Acceda a este menú para personalizar la configuración estándar de RS232. Los datos pueden pasarse a una impresora o un ordenador.</p>	
--	--

5.5.1 Baud Rate (Velocidad en baudios)

<p>Configura la velocidad en baudios (bits por segundo).</p>	
<p>1200 = 1200 bps 2400 = 2400 bps 4800 = 4800 bps 9600 = 9600 bps 19200 = 19200 bps 38400 = 38400 bps</p>	

5.5.2 Transmission (Transmisión)

Configura los bits de datos, bit de parada y paridad.

8-N-1 = 8 bits de datos, sin paridad, bit de parada 1

8-N-2 = 8 bits de datos, sin paridad, bit de parada 2

7-E-1 = 7 bits de datos, paridad par, bit de parada 1

7-E-2 = 7 bits de datos, paridad par, bit de parada 2

7-N-1 = 7 bits de datos, sin paridad, bit de parada 1

7-N-2 = 7 bits de datos, sin paridad, bit de parada 2

7-E-1 = 7 bits de datos, paridad impar, bit de parada 1

7-E-2 = 7 bits de datos, paridad impar, bit de parada 2

<p>PARITY</p> <p>Paridad</p>	<p>8-N-1</p> <p>8 bits de datos, bit de parada 1</p>
-------------------------------------	---

5.5.3 Handshake

Configura el método de control de intercambio.

NONE = no hay intercambio

XON-XOFF = intercambio XON/XOFF

HARDWARE = intercambio de hardware

<p>H.SHAKE</p> <p>Intercambio</p>	<p>NONE</p> <p>Ninguno</p>
<p>XON-XOFF</p> <p>Xon / Xoff</p>	<p>HARDWARE</p> <p>Hardware</p>

5.6 Print Settings (Configuración de impresión)

Acceda a este menú para personalizar la configuración de transferencia de datos.

	<p>Print</p>
--	---------------------

5.6.1 Stable Only (Solo estable)

Off = los valores se imprimen inmediatamente sin importar la estabilidad.

On = los valores se imprimen solo cuando se cumplen los criterios de estabilidad.

	<p>STABLE</p>
--	----------------------

5.6.2 Numeric Only (Solo numérico)

Off = se imprimen todos los resultados seleccionados.

On = solo se imprimen los datos de valores numéricos.

	<p>NUM</p>
--	-------------------

5.6.3 Single Header (Encabezado sencillo)

Off = se imprimen los encabezados por cada impresión. On = los encabezados se imprimen una vez al día.	5 in.HEAD
--	-----------

5.6.4 Auto Print (Impresión automática)

Activa o desactiva la funcionalidad de impresión automática y el modo específico de impresión automática.	A.Pr int
---	----------

1. Off = desactivado	OFF
2. Cuando estable = imprime solo cuando se cumplen los criterios de estabilidad.	ON.STAB

Cuando está seleccionada la opción «cuando estable», configure las condiciones para la impresión. Carga = imprime cuando la carga indicada es estable.	LoAd
Carga cero = imprime cuando la carga cero indicada es estable.	LoAd.ZEr

3. Intervalo de impresión = imprime en el intervalo de tiempo definido. Cuando «intervalo de impresión» está seleccionado, configure el intervalo de tiempo utilizando el teclado numérico. Nota: Hay disponibles ajustes de 1 a 3600 segundos. El valor predeterminado es 0.	intEr
---	-------

4. Continuo = imprime de manera continua.	Cont inu
--	----------

5.6.5 Header (Encabezado)

On = imprime el encabezado. Off = no imprime el encabezado.	HEADEr
---	--------

5.6.6 Date and Time (Fecha y hora)

<p>On = imprime la fecha y la hora. Off = no imprime la fecha ni la hora.</p>	
--	--

5.6.7 Balance ID (Id. De la báscula)

<p>On = imprime el Id. de la balanza. Off = no imprime el Id. de la balanza.</p>	
---	--

5.6.8 Balance Name (Nombre de la báscula)

<p>On = imprime el nombre de la balanza. Off = no imprime el nombre de la balanza.</p>	
---	--

5.6.9 User Name (Nombre de usuario)

<p>On = imprime el nombre de usuario. Off = no imprime el nombre de usuario.</p>	
---	--

5.6.10 Project Name (Nombre del proyecto)

<p>On = imprime el nombre del proyecto. Off = no imprime el nombre del proyecto.</p>	
---	--

5.6.11 Application Name (Nombre de la aplicación)

<p>On = imprime el nombre de la aplicación. Off = no imprime el nombre de la aplicación.</p>	
---	--

5.6.12 Result (Resultados)

<p>On = imprime el resultado del pesaje. Off = no imprime el resultado del pesaje.</p>	
---	--

5.6.13 Gross (Bruto)

<p>On = imprime el peso bruto. Off = no imprime el peso bruto.</p>	
---	--

5.6.14 Net (Neto)

<p>On = imprime el peso neto. Off = no imprime el peso neto.</p>	<p>NET</p>
---	------------

5.6.15 Tare (Tara)

<p>On = imprime el valor de tara. Off = no imprime el valor de tara.</p>	<p>TARA</p>
---	-------------

5.6.16 Signature Line (Línea de firma)

<p>On = se imprime la línea de firma. Off = la línea de firma no se imprime.</p>	<p>SIGN.L IN</p>
--	------------------

5.6.17 Line Feed (Avance de línea)

<p>1 línea = mueve el papel una línea hacia arriba después de la impresión. 4 líneas = mueve el papel cuatro líneas hacia arriba después de la impresión.</p>	<p>FEED</p>
<p>1 LINE 1 Line</p>	<p>4 LINES 4 Lines</p>

5.7 GLP

<p>Acceda a este menú para establecer las buenas prácticas de laboratorio (GLP).</p>	<p>GLP</p>
--	------------

5.7.1 Header (Encabezado)

<p>Permite la impresión de los encabezados. Hay 3 encabezados disponibles. Hay disponibles ajustes alfanuméricos de hasta 16 caracteres para cada configuración de encabezado.</p>	<p>HEADER 1 Encabezado 1</p>
<p>HEADER 2 Encabezado 2</p>	<p>HEADER 3 Encabezado 3</p>

5.7.2 Balance Name (Nombre de la balanza)

<p>Configura el nombre de la balanza. Hay disponibles ajustes alfanuméricos de hasta 16 caracteres para cada configuración de encabezado.</p>	<p>BAL.NAM</p>
---	----------------

5.7.3 User Name (Nombre de usuario)

<p>Configura el nombre de usuario. Hay disponibles ajustes alfanuméricos de hasta 16 caracteres para cada configuración de encabezado.</p>	
--	--

5.7.4 Project Name (Nombre del proyecto)

<p>Configura el nombre del proyecto. Hay disponibles ajustes alfanuméricos de hasta 16 caracteres para cada configuración de encabezado. El valor predeterminado está en blanco.</p>	
---	--

5.8 Factory reset (Restablecer a fábrica)

<p>Utilice este menú para restablecer todas las configuraciones de menú a sus parámetros por defecto. Reset all = restablece todos los menús a sus ajustes predeterminados. Exit = regresa a la pantalla principal de la aplicación sin restablecer ningún menú.</p>	
--	--

5.9 Lockout (Bloqueo)

<p>Utilice este submenú para bloquear / desbloquear determinados menús. Off = el menú está desbloqueado. On = el menú está bloqueado.</p>	
--	--

6. LEGAL PARA COMERCIO

Cuando la balanza se utiliza en actividades comerciales o una aplicación controlada legalmente, debe ser configurada, verificada y sellada según los reglamentos locales de pesos y medidas. Es la responsabilidad del comprador asegurarse de que se cumplen **todos los requisitos legales pertinentes**.

6.1 Ajustes

Antes de la verificación y el sellado, se deben llevar a cabo los siguientes pasos en orden:

1. Verifique que las configuraciones del menú cumplen con las regulaciones locales en cuanto a pesos y medidas.
2. Verifique que las unidades activadas cumplen con las regulaciones locales en cuanto a pesos y medidas.
3. Realice una calibración tal y como se explica en la sección Calibración.
4. Acceda al menú de Calibración y active la Calibración Interna, asegurándose de que cumple con las regulaciones locales en cuanto a pesos y medidas.
 - a) Pulse el botón **Tare / Menu-Cal** y seleccione **InCal**.
 - b) Pulse el botón **Print/Unit** para alternar entre el ajuste de Calibración Interna **On** u **Off**.
Atención: La Calibración Interna debe estar desactivada cuando se utilice la balanza para uso comercial en Canadá.
 - c) Pulse el botón **Zero** para confirmar, y a continuación pulse el botón **Tare / Menu-Cal** para salir del menú.
5. 5. Active el Modo Aprobado en el menú Configuración de la Balanza. Para los modelos con tamaño de graduación seleccionable, ajuste el valor deseado en el menú LFT tal y como se explica en la sección de **Modo Aprobado**.
6. Para los modelos certificados por Measurement Canada y NTEP con tamaño de graduación seleccionable, coloque la etiqueta de capacidad y legibilidad adecuada en la balanza en la ubicación que se muestra a continuación.
 - a) Extraiga del embalaje el juego de dos etiquetas.
 - b) Tome la etiqueta correspondiente al tamaño de la graduación configurada en el menú LFT.
 - c) Retire la cubierta protectora de plástico transparente del terminal, si corresponde.
 - d) Retire el revestimiento del adhesivo y coloque la etiqueta en la zona situada encima de la pantalla.
 - e) Vuelva a colocar la cubierta protectora de plástico transparente, si corresponde.

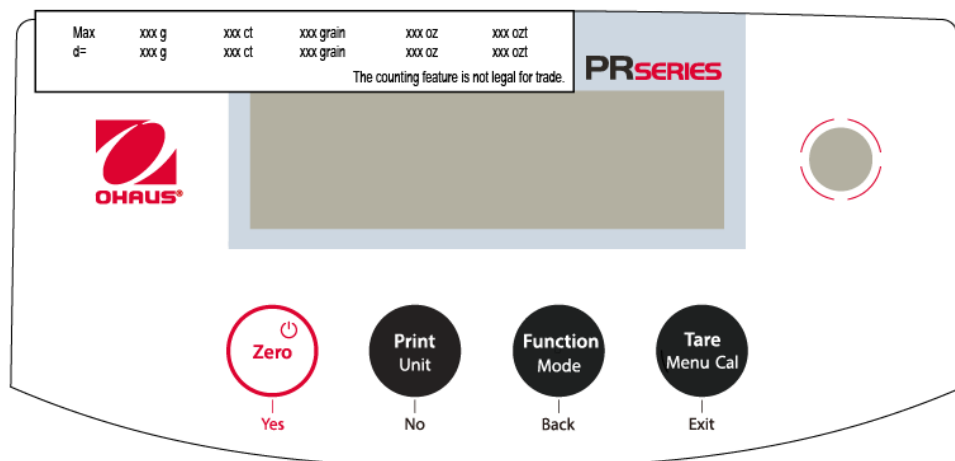

Nota: cuando el modo aprobado está ajustado en ON, no se puede realizar la calibración externa.

6.2 Verificación

Un funcionario oficial de pesos y medidas o un agente de servicio autorizado debe realizar el procedimiento de verificación.

6.3 Sellado

Una vez que la balanza ha sido verificada, debe ser sellada para prevenir un acceso no detectado a las configuraciones sujetas a control legal. Antes de sellar el dispositivo, asegúrese de que el interruptor de seguridad esté en la posición «bloqueado», y el ajuste modo aprobado en el menú de configuración de la balanza está establecido en ON, activado.

- Si utiliza un sello de papel, coloque el sello sobre el interruptor de seguridad y la cubierta inferior como se muestra.
- Si utiliza un cable de sellado, pase el cable de sellado a través de los agujeros en el interruptor de seguridad y la cubierta inferior como se muestra.



Figura 6-1. Sellado

7. IMPRESIÓN

7.1 Conectar, configurar y probar la impresora / interfaz del ordenador

Utilice el puerto RS-232 integrado para conectar a un ordenador o impresora. Si se conecta a un ordenador, utilice HyperTerminal o un software similar, como SPDC descrito a continuación. (En Windows XP, HyperTerminal se encuentra en **Accesorios / Comunicaciones**).

Conecte el ordenador con un cable serie estándar (directo).

Seleccione **Conexión nueva**, «conectar mediante» COM1 (o puerto COM disponible).

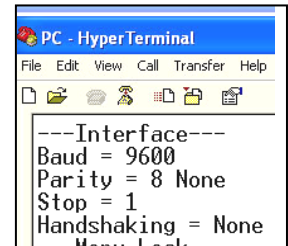

Seleccione **Baud=9600; Parity=8 None; Stop=1; Handshaking=None**. Haga clic en **OK**.

Seleccione Properties/Settings (Propiedades/Ajustes) y, a continuación, ASCII Setup. Marque las casillas como se ilustra:

(**S**end line ends...; **E**cho typed characters...; **W**rap lines...)

Utilice los comandos de la interfaz RS232 (sección 9.6.1) para controlar la balanza desde un ordenador.

Software SPDC

Ohaus proporciona el software SPDC / Recopilación de datos de puerto serie, y puede utilizarse en sistemas operativos que no tienen el software HyperTerminal mencionado anteriormente. El software SPDC puede recopilar y transferir preliminarmente los datos a archivos de Microsoft (como Excel, Word, etc.).

Seleccione el tipo de archivo de exportación y la ruta del archivo de exportación y pulse «Run» (ejecutar) como se muestra a continuación.

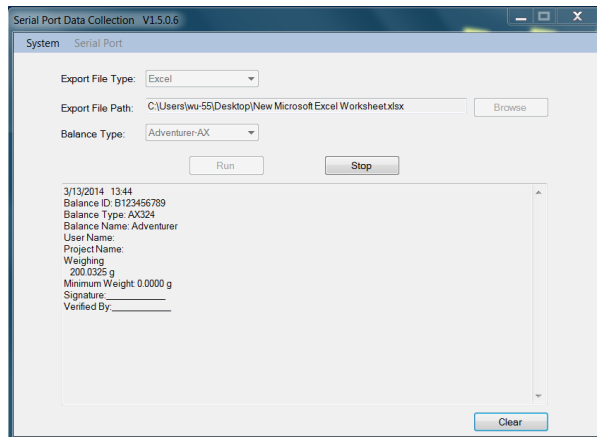

Requisitos del sistema

- Ordenador con Windows 98®, Windows 98SE®, Windows ME®, Windows 2000®, Windows XP®, Windows 7® o Windows 8® (32-bit).

Nota: el software SPDC más reciente es compatible con los idiomas inglés y chino, y se puede descargar desde el sitio web de Ohaus. Para obtener más información, consulte el *Manual de instrucciones SPDC de recopilación de datos*.

7.2 Formato de salida

Los datos de los resultados, y los datos G/N/T, tienen el siguiente formato de salida.

Campo:	Etiqueta ¹	Espacio ²	Peso ³	Espacio ²	Unidad ⁴	Espacio	Estabilidad ⁵	Espacio	G/N ⁶	Espacio	Caracteres terminación
Longitud:		1	11	1	5	1	≤ 1	≤ 1	≤ 3	0	≤ 8

Nota:

1. La longitud del campo de etiqueta no es fija.
2. Cada campo es seguido por un único espacio de delimitación (ASCII 32).
3. El campo «peso» consta de 11 caracteres justificados a la derecha. Si el valor es negativo, el carácter «-» se sitúa inmediatamente antes del dígito más a la izquierda.
4. El campo «unidad» contiene la abreviatura de la unidad de medida hasta un máximo de 5 caracteres, justificado a la derecha.
5. El campo «estabilidad» contiene el carácter «?» si la lectura del peso no es estable. El campo «estabilidad» y el campo «espacio» se omiten si la lectura del peso es estable.
6. El campo «G/N» muestra la lectura del peso neto o bruto. Para pesos netos, el campo muestra «N». Para pesos brutos, el campo muestra «G».
7. El campo «caracteres de terminación» contiene CRLF, cuatro CRLF o Form Feed (avance de página) (ASCII 12), dependiendo de la configuración del menú AVANCE DE LÍNEA.
8. Cuando «solo numérico» está activado, solo se imprime el campo «peso», alineado a la izquierda.

7.3 Ejemplos de impresión

Se muestran ejemplos de cada aplicación con todos los factores en **ON** en el menú **Imprimir**. También se muestran los valores predeterminados para las líneas de **Encabezado** 1-3.

Pesaje básico

Pesaje de recuento

Pesaje porcentual

```

Header 1
Header 2
Header 3
07/19/2017 17:56:23
Balance ID: B234567890
Balance Name: PR4202/E
User Name:
Project Name:
Weigh
    0.10 g
Gross:    0.10 g G
Net:      0.10 g N
Tare:     0.00 g T

Signature: _____
Verified By: _____
    
```

```

Header 1
Header 2
Header 3
07/19/2017 17:57:19
Balance ID: B234567890
Balance Name: PR4202/E
User Name:
Project Name:
Count
Quantity: 4999 PCS
Gross:    49.99 g G
Net:      49.99 g N
Tare:     0.00 g T
APW: 0.010 g
Sample Size: 10 PCS

Signature: _____
Verified By: _____
    
```

```

Header 1
Header 2
Header 3
07/19/2017 17:57:19
Balance ID: B234567890
Balance Name: PR223/E
User Name:
Project Name:
Percent
Percentage: 10.156 % N
Gross:    23.361 g G
Net:      10.156 g N
Tare:     13.205 g T
Reference weight: 100.000 g

Signature: _____
Verified By: _____
    
```

Calibración interna

-OHAUS-
07/26/2017 05:16:53
Balance ID:
Balance Name: PR2202
User Name:
Project Name:
---Internal Calibration---
Calibration is done.
Difference weight: 0.00 g

Signature: _____
Verified By: _____

Calibración de span

-OHAUS-
07/26/2017 05:16:37
Balance ID:
Balance Name: PR2202
User Name:
Project Name:
---Span Calibration---
Calibration is done.
Reference weight: 2000.00 g
Actual weight: 2000.22 g
Difference weight: 0.22 g
Weight ID: _____

Signature: _____
Verified By: _____

Calibración de linealidad

-OHAUS-
07/26/2017 05:16:11
Balance ID:
Balance Name: PR2202
User Name:
Project Name:
---Linear Calibration---
Calibration is done.

Signature: _____
Verified By: _____

8. MANTENIMIENTO

8.1 Calibración

Compruebe periódicamente la calibración colocando un peso exacto en la balanza y observando el resultado. Si es necesario realizar una calibración, consulte las instrucciones en la sección 5.2.

8.2 Limpieza



ADVERTENCIA: desconecte el equipo de la fuente de alimentación antes de su limpieza. Asegúrese de que no entre líquido en el interior de la balanza.



Limpie la balanza a intervalos regulares.



La superficie de la carcasa puede limpiarse con un paño sin pelusas ligeramente humedecido con agua o un limpiador suave.



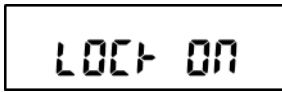

Las superficies de vidrio pueden limpiarse con un limpiacristales comercial.

Atención: no utilice disolventes, amoníaco, ni productos químicos o de limpieza abrasivos.

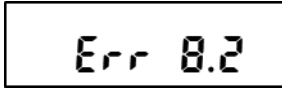
8.3 Solución de problemas

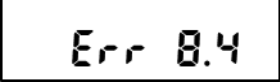
TABLA 8-1. SOLUCIÓN DE PROBLEMAS

Síntoma / Pantalla	Causa posible	Solución
No se pueden cambiar las configuraciones del menú 	El submenú está bloqueado	Desbloquee el submenú en el Menú de Bloqueo.
Algunos submenús están ocultos	Este es un modelo aprobado, lo que requiere el bloqueo de algunos submenús.	Configure la báscula antes de encender la configuración «Legal for Trade».
	El entorno no es estable	Mueva la báscula a una ubicación adecuada y calibre de nuevo.
	Se utilizan masas de calibración incorrectas	Utilice las masas de calibración para calibrar según los puntos de calibración correctos que figuran en la tabla de especificaciones del manual de instrucciones.
	Error del sistema	Si el error continúa, contacte con el servicio de atención al cliente de Ohaus (www.ohaus.com - Más - Contacte con nosotros)
	Al encender, se utiliza una bandeja de pesaje inadecuada.	Utilice la bandeja de pesaje original de OHAUS antes de encender.
	La carga sobre la bandeja supera la configuración de pesaje inicial.	Retire la carga de la bandeja antes de encender.
	Al encender, se utiliza una bandeja de pesaje inadecuada.	Utilice la bandeja de pesaje original de OHAUS antes de encender.
	La bandeja no está instalada al encender.	Instale la bandeja de pesaje antes de encender.

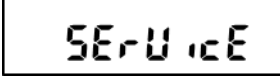
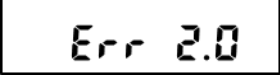
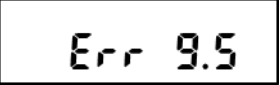
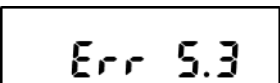
	<p>El peso sobre la bandeja es demasiado pesado.</p>	<p>Reduzca el tamaño de la muestra hasta que el peso esté dentro de la capacidad de pesaje.</p>
	<p>La bandeja no está instalada correctamente.</p>	<p>Instale la bandeja de pesaje antes de encender.</p>
	<p>El peso medio de la pieza (APW) de la muestra es demasiado pequeño (menos de 0,1 d) en el modo de Conteo de Piezas.</p>	<p>Vuelva a calcular el valor APW. Si el error continúa, utilice una muestra diferente.</p>
	<p>El peso de referencia de la bandeja es demasiado pequeño (menos de 100 d) en el modo de Pesaje Porcentual.</p>	<p>Coloque más muestras sobre la bandeja.</p>
	<p>Error del sistema</p>	<p>Contacte con el servicio de atención al cliente de Ohaus (www.ohaus.com - Más - Contacte con nosotros)</p>
	<p>El entorno no es estable</p>	<p>Mueva la báscula a una ubicación adecuada.</p>
<p>Al presionar Tara/Cero</p> 	<p>El valor está fuera del rango cero. El rango cero depende de la región,</p>	<p>Realice de nuevo el ajuste del Cero de acuerdo con los requisitos locales.</p>
	<p>El valor de tara es un valor negativo.</p>	<p>Pulse Cero en lugar de Tara</p>
	<p>Error del sistema</p>	<p>Contacte con el servicio de atención al cliente de Ohaus (www.ohaus.com - Más - Contacte con nosotros)</p>
  	<p>Error del sistema</p>	<p>Desconecte de la corriente y reinicie. Si el error continúa, póngase en contacto con el servicio de atención al cliente de OHAUS (www.ohaus.com - Más - Contacte con nosotros)</p>

8.4 Información de servicio

Si la sección de solución de problemas no resuelve su problema, póngase en contacto con su agente de servicio autorizado de Ohaus. Visite nuestro sitio web www.ohaus.com para localizar la oficina de Ohaus más cercana a usted.

9. DATOS TÉCNICOS

9.1 Especificaciones

Condiciones ambientales

- Uso de interior solamente
- Altitud: hasta 2000 m
- Rango de temperatura: 10 °C a 30 °C
- Humedad: máxima humedad relativa 80 % para temperaturas hasta 30 °C, disminuyendo linealmente a 50 % de humedad relativa a 40 °C.
- La operabilidad se garantiza a temperaturas ambiente entre 5°C y 40°C
- Fluctuaciones de voltaje del suministro eléctrico: hasta ± 10 % el voltaje nominal
- Categoría de instalación II
- Grado de contaminación: 2
- Voltaje de alimentación: 12 V=0.5 A

Materiales

- Carcasa inferior: aluminio fundido, pintado + plástico (HIPS)
- Carcasa superior: plástico (HIPS)
- Plataformas de pesaje: acero inoxidable
- Cámara de pesaje: vidrio, plástico (HIPS)
- Pies: plástico (ABS)

TABLE 9-1. ESPECIFICACIONES

Modelo InCal		PR124	PR224	PR223	PR423	PR523
Modelo ExCal	PR64/E	PR124/E	PR224/E	PR223/E	PR423/E	PR523/E
Capacidad (g)	62	120	220	220	420	520
Legibilidad d (g)	0,0001	0,0001	0,0001	0,001	0,001	0,001
Repetibilidad (sd.), ≤5% de la carga completa (g)	0.00008	0.00008	0.00008	0.0008	0.0008	0.0008
Repetibilidad (sd.), 5% de carga completa a rango completo (g)	0.0001	0.0001	0.0001	0.001	0.001	0.001
Desviación de linealidad típica (g)	± 0.00006	± 0.00006	± 0.00006	±0.0006	±0.0006	±0.0006
Desviación de linealidad (g)	± 0.0002	± 0.0002	± 0.0002	±0.002	±0.002	±0.002
Tiempo de estabilización típico (s)	3	3	3	2	2	2
Deriva térmica de sensibilidad (PPM/K)	±3	±3	±3	±8	±3	±3
Peso mínimo típico USP (USP K=2,U=0.10 %)	160 mg	160 mg	160 mg	1,6 g	1,6 g	1,6 g
Peso Mín. optimizado (g) (USP, u=0.10 %, k=2) SRP ≤ 0.41 d*	82 mg	82 mg	82 mg	0,82 g	0,82 g	0,82 g
Unidades	Gramos, Miligramos, Carats, Onza, Onza troy, Pennyweight, Grano, Taiwan Tael, Newton, Custom 1			Gramos, Miligramos, Kilogramos, Carats, Onza, Onza troy, Pennyweight, Grano, Libra, Taiwan Tael, Newton, Custom 1		
Aplicaciones	Pesaje básico; recuento de piezas; pesaje porcentual					
Tamaño de la plataforma (diámetro)	3.5 in / 9 cm	3.5 in / 9 cm	3.5 in / 9 cm	4.7 in / 12 cm	4.7 in / 12 cm	4.7 in / 12 cm
Puntos de calibración de span (g)	50, 60	50, 100	100, 200	100, 200	200, 400	300, 500
Puntos de calibración de linealidad (g)	0, 30, 60	0, 50, 100	0, 100, 200	0, 100, 200	0, 200, 400	0, 250, 500
Rango de tara	A capacidad por sustracción					
Alimentación	Potencia de entrada: 100-240 V ~ 200 mA 50-60Hz 12-18VA Potencia de salida: 12 VDC 0.5A					
Dimensiones (L. x An. x Al.) (mm)	201 x 317 x 303 mm 7.9 x 12.5 x 11.9 inch					
Comunicación	RS232					
Rango de temperatura de funcionamiento	Condiciones de funcionamiento para aplicaciones habituales de laboratorio: de 10°C a 30 °C (operabilidad garantizada entre 5°C y 40 °C)					
Rango de temperatura de almacenamiento	Humedad: máxima humedad relativa 80 % para temperaturas hasta 30 °C, disminuyendo linealmente a 50 % de humedad relativa a 40 °C					
Condiciones de almacenamiento	-10 °C a 60 °C, humedad 10 % a 90 %, sin condensación					
Peso neto	10 lb / 4.5 kg					
Peso de transporte	15,4 lb / 7 kg					
Dimensiones de transporte (L. x An. x Al.) (mm)	507 x 387 x 531					

* SRP se refiere a la desviación estándar para n pesajes repetidos (n≥10).

TABLE 9-2. ESPECIFICACIONES (CONT.)

Modelo InCal	PR1602	PR2202	PR4202		PR4201	PR6201
Modelo ExCal	PR1602/E	PR2202/E	PR4202/E	PR2201/E	PR4201/E	PR6201/E
Capacidad (g)	1600	2200	4200	2200	4200	6200
Legibilidad d (g)	0,01	0,01	0,01	0.1	0,1	0,1
Repetibilidad (sd.), ≤5% de la carga completa (g)	0.008	0.008	0.008	0.08	0.08	0.08
Repetibilidad (sd.), 5% de carga completa a rango completo (g)	0.01	0.01	0.01	0.1	0.1	0.1
Desviación de linealidad típica (g)	±0.006	±0.006	±0.006	±0.06	±0.06	±0.06
Desviación de linealidad (g)	±0.02	±0.02	±0.02	±0.2	±0.2	±0.2
Tiempo de estabilización típico (s)	1	1	1	1	1	1
Deriva térmica de sensibilidad (PPM/K)	±6	±6	±3	±10	±10	±10
Peso mínimo típico USP (USP K=2,U=0.10 %)	16 g	16 g	16 g	160 g	160 g	160 g
Peso Mín. optimizado (g) (USP, u=0.10 %, k=2) SRP ≤ 0.41 d*	8,2 g	8,2 g	8,2 g	82 g	82 g	82 g
Unidades	gramo, kilogramo, quilate, Newton, libra, onza, onza troy, pennyweight grano, Taiwan Tael, Custom 1					
Aplicaciones	Pesaje básico; recuento de piezas; pesaje porcentual					
Tamaño de la plataforma (diámetro)	7.1 in / 18 cm	7.1 in / 18 cm	7.1 in / 18 cm	7.1 in / 18 cm	7.1 in / 18 cm	7.1 in / 18 cm
Puntos de calibración de span (g)	1000, 1500, 1600	1000, 2000	2000, 4000	1000, 2000	2000, 4000	5000, 6000
Puntos de calibración de linealidad (g)	0, 800, 1600	0, 1000, 2000	0, 2000, 4000	0, 1000, 2000	0, 2000, 4000	0, 3000, 6000
Rango de tara	A capacidad por sustracción					
Alimentación	Potencia de entrada: 100-240 V ~ 200 mA 50-60Hz 12-18VA Potencia de salida: 12 VDC 0.5A					
Dimensiones (L. x An. x Al.) (mm)	201 x 317 x 93 mm 7.9 x 12.5 x 3.7 inch					
Comunicación	RS232					
Rango de temperatura de funcionamiento	Condiciones de funcionamiento para aplicaciones habituales de laboratorio: de 10°C a 30 °C (operabilidad garantizada entre 5°C y 40 °C)					
Rango de temperatura de almacenamiento	Humedad: máxima humedad relativa 80 % para temperaturas hasta 30 °C, disminuyendo linealmente a 50 % de humedad relativa a 40 °C					
Condiciones de almacenamiento	-10 °C a 60 °C, humedad 10 % a 90 %, sin condensación					
Peso neto	7,7 lb / 3,5 kg					
Peso de transporte	11 lb / 5 kg					
Dimensiones de transporte (L. x An. x Al.) (mm)	550 x 385 x 291					

* SRP se refiere a la desviación estándar para n pesajes repetidos (n≥10).

TABLE 9-3. ESPECIFICACIONES (CONT.)

Modelo InCal	PR523N	
Modelo ExCal	PR323N/E	PR523N/E
Capacidad (g)	320	520
Legibilidad d (g)	0.001 o 0.01	0.001 o 0.01
Intervalo de verificación e (g)	0.01	0.01
Clase	II	II
Repetibilidad (sd.), ≤5% de la carga completa (g)	0.0008	0.0008
Repetibilidad (sd.), 5% de carga completa a rango completo (g)	0.001	0.001
Desviación de linealidad típica (g)	± 0.0006	± 0.0006
Desviación de linealidad (g)	± 0.002	± 0.002
Carga excéntrica	No exceder el error máximo permitido para un tercio de la capacidad total del saldo	
Tiempo de estabilización típico (s)	2	2
Deriva térmica de sensibilidad (PPM/K)	±3	±3
Peso mínimo típico USP (USP K=2,U=0.10 %)	1,6g	1,6g
Peso Mín. optimizado (g) (USP, u=0.10 %, k=2) SRP ≤ 0.41 d*	0.82g	0.82g
Unidades	gramo, Miligramo, quilate, onza, onza troy, grano	
Aplicaciones	Pesaje básico; recuento de piezas; pesaje porcentual	
Tamaño de la plataforma (diámetro)	4.7 in / 12 cm	4.7 in / 12 cm
Puntos de calibración de span (g)	200,300	300, 500
Puntos de calibración de linealidad (g)	0, 150, 300	0, 250, 500
Rango de tara	A capacidad por sustracción	
Alimentación	Potencia de entrada: 100-240 V ~ 200 mA 50-60Hz 12-18VA Potencia de salida: 12 VDC 0.5A	
Dimensiones (L. x An. x Al.) (mm)	201 x 317 x 303 mm 7.9 x 12.5 x 11.9 inch	
Comunicación	RS232	
Rango de temperatura de funcionamiento	Condiciones de funcionamiento para aplicaciones habituales de laboratorio: de 10°C a 30 °C (operabilidad garantizada entre 5°C y 40 °C)	
Rango de temperatura de almacenamiento	Humedad: máxima humedad relativa 80 % para temperaturas hasta 30 °C, disminuyendo linealmente a 50 % de humedad relativa a 40 °C	
Condiciones de almacenamiento	-10 °C a 60 °C, humedad 10 % a 90 %, sin condensación	
Peso neto	10 lb / 4.5 kg	10 lb / 4.5 kg
Peso de transporte	15.4 lb / 7 kg	15.4 lb / 7 kg
Dimensiones de transporte (L. x An. x Al.) (mm)	507 x 387 x 531mm 20 x 15 x 21 inch	

* SRP se refiere a la desviación estándar para n pesajes repetidos (n≥10).

Table 9-4 ESPECIFICACIONES (CONT.)

Modelo ExCal	PR322N/E	PR522N/E	PR822N/E	PR2202N/E	PR4202N/E	PR5202N/E
Capacidad (g)	320	520	820	2200	4200	5200
Legibilidad d (g)	0.01	0.01	0.1	0.01 o 0.1	0.01 o 0.1	0.01 o 0.1
Intervalo de verificación e (g)	0.01	0.01	0.1	0.1	0.1	0.1
Clase	II	II	III	II	II	II
Repetibilidad (sd.), ≤5% de la carga completa (g)	0.008	0.008	0.008	0.008	0.008	0.008
Repetibilidad (sd.), 5% de carga completa a rango completo (g)	0.01	0.01	0.01	0.01	0.01	0.01
Desviación de linealidad típica (g)	±0.006	±0.006	±0.006	±0.006	±0.006	±0.006
Desviación de linealidad (g)	±0.02	±0.02	±0.02	±0.02	±0.02	±0.02
Carga excéntrica	No exceder el error máximo permitido para un tercio de la capacidad total del saldo					
Tiempo de estabilización típico (s)	1	1	1	1	1	1
Deriva térmica de sensibilidad (PPM/K)	±3	±3	±6	±6	±3	±3
Peso mínimo típico USP (USP K=2,U=0.10 %)	16g	16g	16g	16g	16g	16g
Peso Mín. optimizado (g) (USP, u=0.10 %, k=2) SRP ≤ 0.41 d*	8.2g	8.2g	8.2g	8.2g	8.2g	8.2g
Unidades	gramo, kilogramo, quilate, libra, onza, onza troy, grano					
Aplicaciones	Pesaje básico; recuento de piezas; pesaje porcentual					
Tamaño de la plataforma (diámetro)	4.7 in / 12 cm			7.1 in / 18 cm		
Puntos de calibración de span (g)	200, 300	300,500	500,800	1000, 2000	2000, 4000	3000, 5000
Puntos de calibración de linealidad (g)	0, 150, 300	0, 250, 500	0, 400, 800	0, 1000, 2000	0, 2000, 4000	0, 2500, 5000
Rango de tara	A capacidad por sustracción					
Alimentación	Potencia de entrada: 100-240 V ~ 200 mA 50-60Hz 12-18VA Potencia de salida: 12 VDC 0.5A					
Dimensiones (L. x An. x Al.) (mm)	201 x 317 x 303 mm 7.9 x 12.5 x 11.9 inch			201 x 317 x 93 mm 7.9 x 12.5 x 3.7 inch		
Comunicación	RS232					
Rango de temperatura de funcionamiento	Condiciones de funcionamiento para aplicaciones habituales de laboratorio: de 10°C a 30 °C (operabilidad garantizada entre 5°C y 40 °C)					
Rango de temperatura de almacenamiento	Humedad: máxima humedad relativa 80 % para temperaturas hasta 30 °C, disminuyendo linealmente a 50 % de humedad relativa a 40 °C					
Condiciones de almacenamiento	-10 °C a 60 °C, humedad 10 % a 90 %, sin condensación					
Peso neto	10 lb / 4.5 kg			7.7 lb / 3.5 kg		
Peso de transporte	15.4 lb / 7 kg			11 lb / 5 kg		
Dimensiones de transporte (L. x An. x Al.) (mm)	507 x 387 x 531 mm 20 x 15 x 21 inch			550 x 385 x 291 mm 22 x 15 x 12 inch		

* SRP se refiere a la desviación estándar para n pesajes repetidos (n≥10).

Table 9-5 ESPECIFICACIONES (CONT.)

Modelo ExCal	PR2201N/E	PR4201N/E	PR5201N/E	PR6201N/E
Capacidad (g)	2200	4200	5200	6200
Legibilidad d (g)	0.1	0.1	0.1	0.1 o 1
Intervalo de verificación e (g)	0.1	0.1	0.1	1
Clase	II	II	II	III
Repetibilidad (sd.), ≤5% de la carga completa (g)	0.08	0.08	0.08	0.08
Repetibilidad (sd.), 5% de carga completa a rango completo (g)	0.1	0.1	0.1	0.1
Desviación de linealidad típica (g)	±0.06	±0.06	±0.06	±0.06
Desviación de linealidad (g)	±0.2	±0.2	±0.2	±0.2
Carga excéntrica	No exceder el error máximo permitido para un tercio de la capacidad total del saldo			
Tiempo de estabilización típico (s)	1	1	1	1
Deriva térmica de sensibilidad (PPM/K)	±10	±10	±3	±10
Peso mínimo típico USP (USP K=2,U=0.10 %)	160g	160g	160g	160g
Peso Mín. optimizado (g) (USP, u=0.10 %, k=2) SRP ≤ 0.41 d*	82g	82g	82g	82g
Unidades	gramo, kilogramo, quilate, libra, onza, onza troy, grano			
Aplicaciones	Pesaje básico; recuento de piezas; pesaje porcentual			
Tamaño de la plataforma (diámetro)	7.1 in / 18 cm			
Puntos de calibración de span (g)	1000, 2000	2000, 4000	3000, 5000	5000, 6000
Puntos de calibración de linealidad (g)	0, 1000, 2000	0, 2000, 4000	0, 2500, 5000	0, 3000, 6000
Rango de tara	A capacidad por sustracción			
Alimentación	Potencia de entrada: 100-240 V ~ 200 mA 50-60Hz 12-18VA Potencia de salida: 12 VDC 0.5A			
Dimensiones (L. x An. x Al.) (mm)	201 x 317 x 93 mm 7.9 x 12.5 x 3.7 inch			
Comunicación	RS232			
Rango de temperatura de funcionamiento	Condiciones de funcionamiento para aplicaciones habituales de laboratorio: de 10°C a 30 °C (operabilidad garantizada entre 5°C y 40 °C)			
Rango de temperatura de almacenamiento	Humedad: máxima humedad relativa 80 % para temperaturas hasta 30 °C, disminuyendo linealmente a 50 % de humedad relativa a 40 °C			
Condiciones de almacenamiento	-10 °C a 60 °C, humedad 10 % a 90 %, sin condensación			
Peso neto	7.7 lb / 3.5 kg			
Peso de transporte	11 lb / 5 kg			
Dimensiones de transporte (L. x An. x Al.) (mm)	550 x 385 x 291 mm 22 x 15 x 12 inch			

* SRP se refiere a la desviación estándar para n pesajes repetidos (n≥10).

Table 9-6 ESPECIFICACIONES (CONT.)

Modelo InCal Approval	PR124M	PR224M	PR223M	PR323M	PR423M	PR523M
Capacidad (g)	120	220	220	320	420	520
Legibilidad d (g)	0.0001	0.0001	0.001	0.001	0.001	0.001
Intervalo de verificación (g)	0.001	0.001	0.01	0.01	0.01	0.01
Clase	I	I	II	II	II	II
Repetibilidad (sd.), ≤5% de la carga completa (g)	0.00008	0.00008	0.0008	0.0008	0.0008	0.0008
Repetibilidad (sd.), 5% de carga completa a rango completo (g)	0.0001	0.0001	0.001	0.001	0.001	0.001
Desviación de linealidad típica (g)	± 0.00006	± 0.00006	±0.0006	±0.0006	±0.0006	±0.0006
Desviación de linealidad (g)	± 0.0002	± 0.0002	±0.002	±0.002	±0.002	±0.002
Tiempo de estabilización típico (s)	3	3	2	2	2	2
Deriva térmica de sensibilidad (PPM/K)	±3	±3	±3	±3	±3	±3
Peso mínimo típico USP (USP K=2,U=0.10 %)	160 mg	160 mg	1.6 g	1.6 g	1.6 g	1.6 g
Peso Mín. optimizado (g) (USP, u=0.10 %, k=2) SRP ≤ 0.41 d*	82 mg	82 mg	0.82 g	0.82 g	0.82 g	0.82 g
Unidades	g, mg, ct					
Aplicaciones	Pesaje básico, recuento de piezas, pesaje porcentual, pesaje dinámico, determinación de la densidad					
Tamaño de la plataforma (diámetro, mm)	90	90	120	120	120	120
Puntos de calibración de span (g)	50, 100	100, 200	100, 200	200, 300	200, 400	300, 500
Puntos de calibración de linealidad (g)	0, 50, 100	0, 100, 200	0, 100, 200	0, 150, 300	0, 200, 400	0, 250, 500
Rango de tara	A capacidad por sustracción					
Alimentación	Potencia de entrada: 12V DC 1A de CC/CA alimentación externa					
Dimensiones (L. x An. x Al.) (mm)	209 x 321 x 309					
Comunicación	RS232					
Rango de temperatura de funcionamiento	Condiciones de funcionamiento para aplicaciones habituales de laboratorio: de 10°C a 30 °C (operabilidad garantizada entre 5°C y 40 °C)					
Rango de temperatura de almacenamiento	Humedad: máxima humedad relativa 80% para temperaturas hasta 30 °C, disminuyendo linealmente a 50 % de humedad relativa a 40 °C					
Condiciones de almacenamiento	-10°C to 60°C, humidity 10% to 90%, without condensation					
Peso neto	10 lb / 4.5 kg					
Peso de transporte	15.4 lb / 7 kg					
Dimensiones de transporte (L. x An. x Al.) (mm)	507 x 387 x 531					

* SRP se refiere a la desviación estándar para n pesajes repetidos (n≥10).

Table 9-7 ESPECIFICACIONES (CONT.)

Modelo InCal Approval	PR1602M	PR2202M	PR4202M	PR5202M	PR4201M	PR6201M
Capacidad (g)	1600	2200	4200	5200	4200	6200
Legibilidad d (g)	0.01	0.01	0.01	0.01	0.1	0.1
Intervalo de verificación (g)	0.1	0.1	0.1	0.1	0.1	1
Clase	II	II	II	II	II	II
Repetibilidad (sd.), ≤5% de la carga completa (g)	0.008	0.008	0.008	0.008	0.08	0.08
Repetibilidad (sd.), 5% de carga completa a rango completo (g)	0.01	0.01	0.01	0.01	0.1	0.1
Desviación de linealidad típica (g)	±0.006	±0.006	±0.006	±0.006	±0.06	±0.06
Desviación de linealidad (g)	±0.02	±0.02	±0.02	±0.02	±0.2	±0.2
Tiempo de estabilización típico (s)	1	1	1	1	1	1
Deriva térmica de sensibilidad (PPM/K)	±3	±3	±3	±3	±10	±10
Peso mínimo típico USP (USP K=2,U=0.10 %)	16 g	16 g	16 g	16 g	160 g	160 g
Peso Mín. optimizado (g) (USP, u=0.10 %, k=2) SRP ≤ 0.41 d*	8.2 g	8.2 g	8.2 g	8.2 g	82 g	82 g
Unidades	g, kg, ct					
Aplicaciones	Pesaje básico, recuento de piezas, pesaje porcentual, pesaje dinámico, determinación de la densidad					
Tamaño de la plataforma (diámetro, mm)	180	180	180	180	180	180
Puntos de calibración de span (g)	1000, 1500, 1600	1000, 2000	2000, 4000	3000, 5000	2000, 4000	5000, 6000
Puntos de calibración de linealidad (g)	0, 800, 1600	0, 1000, 2000	0, 2000, 4000	0, 2500, 5000	0, 2000, 4000	0, 3000, 6000
Rango de tara	To capacity by subtraction					
Alimentación	Potencia de entrada: 12V DC 1A de CC/CA alimentación externa Potencia de salida: 12 VDC 0.5A					
Dimensiones (L. x An. x Al.) (mm)	209 x 321 x 98					
Comunicación	RS232					
Rango de temperatura de funcionamiento	Condiciones de funcionamiento para aplicaciones habituales de laboratorio: de 10°C a 30 °C (operabilidad garantizada entre 5°C y 40 °C)					
Rango de temperatura de almacenamiento	Humedad: máxima humedad relativa 80% para temperaturas hasta 30 °C, disminuyendo linealmente a 50 % de humedad relativa a 40 °C					
Condiciones de almacenamiento	-10 °C a 60 °C, humedad 10 % a 90 %, sin condensación					
Peso neto	7.7 lb / 3.5 kg					
Peso de transporte	11 lb / 5 kg					
Dimensiones de transporte (L. x An. x Al.) (mm)	550 x 385 x 291					

* SRP se refiere a la desviación estándar para n pesajes repetidos (n≥10).

9.2 Esquemas y dimensiones

Dimensiones completamente montado



Figura 9-1. Modelo 0.001 g / 0.0001 g



Figura 9-2. Modelo 0.1 g / 0.01 g

9.3 Accesorios

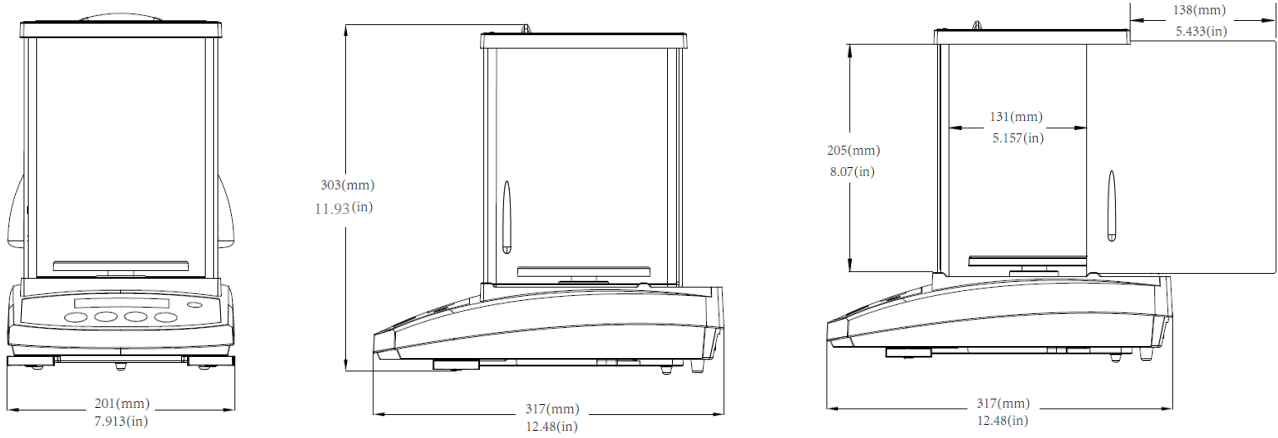
DESCRIPCIÓN	NÚMERO DE PIEZA
Pantalla auxiliar AD7-RS	30472064
Dispositivo de seguridad	80850043
Cable RS232 (25 pin)	80500524
Cable RS232 (9 pin)	80500525
Sobrecubierta	30093334
Cubierta para uso	30372547
Impresora SF40A	30064202 (UE); 30064203 (AM)
Adaptador de corriente para la balanza	46001724

9.4 Comunicación

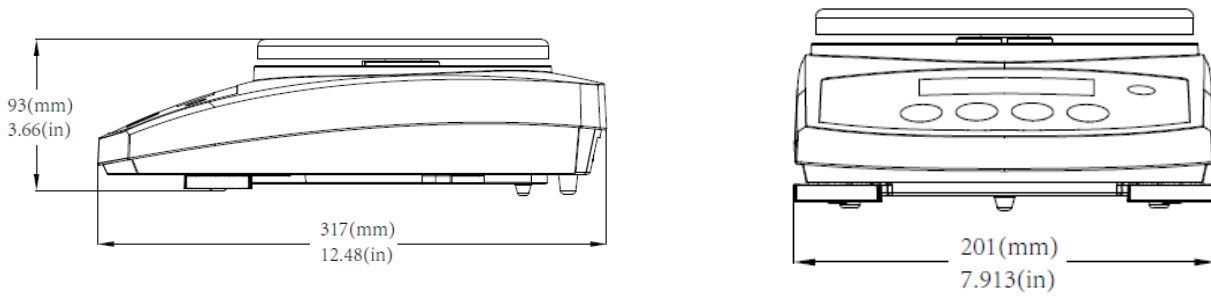
9.4.1 Comandos de la interfaz

La balanza reconoce los comandos que se enumeran en la tabla siguiente.

Comando	Función
IP	Impresión inmediata del peso que se indica (estable o inestable).
P	Impresión del peso que se indica (estable o inestable).
CP	Impresión continua.
SP	Impresión en estabilidad.
SLP	Configura la impresión automática en estabilidad, permite imprimir el peso visualizado que no sea cero.
SLZP	Configura la impresión automática en estabilidad, permite imprimir el peso estable que no sea cero y la lectura estable en cero.
xP	Configura la impresión automática a «intervalo de impresión», x = impresión intervalo (1-3600 s), 0P desactiva el intervalo de impresión
0P	0P desactiva el intervalo de impresión, impresión continua o impresión en estabilidad
H	Introduce líneas de impresión de encabezado, el formato es: H x «cadena de encabezado». Donde x = línea número 1 a 3, la «cadena de encabezado» puede contener un máximo de 24 caracteres alfanuméricos. Si no hay una cadena en el comando, «H x» leerá el encabezado almacenado x.
Z	Igual que al pulsar el botón «Zero»
T	Igual que al pulsar el botón «Tare»
xT***	Establece un valor predeterminado de tara en la unidad que se muestra. x = valor de tara predeterminada. El envío de 0T borra la tara (si permitido).
PT	Imprime el peso de tara almacenado en la memoria.
PM	Imprime el modo aplicación actual (modo pesaje).
xM	Configurar el modo aplicación actual a «x». «x» depende de aplicaciones 1 – Pesaje 2 – Recuento 3 – Porcentaje
M	Navega hasta el siguiente modo habilitado.
ON	Sale del estado de espera
OFF	Pasa al modo de espera.
C	Comienza la calibración de span
IC	Comienza la calibración interna
AC	Cancela la calibración
PSN	Impresión del número de serie
PV	Versión de la impresión: imprime nombre, revisión de software y LFT On (legal para comercio), si LFT está activado.
x#	Configura el recuento de APW (x) a gramos. (debe tener APW almacenado)
P#	Imprime la aplicación de recuento APW.
x%	Configura el peso de referencia de la aplicación de porcentaje (x) en gramos (debe tener el peso de referencia almacenado)
P%	Imprime el peso de referencia de la aplicación de porcentaje.

Comando	Función
PTIME	Imprime la hora actual
PDATE	Imprime la fecha actual
xTIME	Configura la hora x formato: hh:mm:ss
xDATE	Configura la fecha x formato: mm/dd/aaaa
xS	0 = imprime datos inestables, 1 = imprime solo estables
xRL	Activa o desactiva la respuesta «OK» a los comandos de no impresión: x=0 para desactivar, x=1 para activar.
xT	Pre-tara el peso del recipiente (x) en gramos.

9.4.2 RS232 (DB9) Conexiones pin





Diagrama	Tipo	Descripción
	Tipo de interfaz	Interfaz de voltaje cumple con la norma EIA RS-232C/DIN 66020 (CCITT V24/V.28)
	Longitud máxima del cable	15 m
	Relación señal/ruido	Salida: +5 V ... +15 V (RL = 3 – 7kΩ) -5 V ... -15 V (RL = 3 - 7 kΩ) Entrada: +3 V ... +25 V -3 V ... -25 V
	Conector	Sub-D, 9-polos, hembra
	Modo de funcionamiento	Dúplex completo
	modo de transmisión	Bit en serie, asíncrono
	Código de transmisión	ASCII
	Velocidad en baudios	1200, 2400, 4800, 9600, 19200, 38400 (firmware seleccionable)
	Bits/paridad	7-bit/par, 7-bit/impar, 7-bit/ninguno, 8-bit/ninguno (firmware seleccionable)
	Bits de parada	Bit de parada 1, 2
	Handshake	Ninguno, XON/XOFF, RTS/CTS (seleccionable)
	Fin de línea	No seleccionable

10. ACTUALIZACIONES DE SOFTWARE

Ohaus está continuamente mejorando el software de sus balanzas. Para obtener la última versión, póngase en contacto con su distribuidor autorizado de Ohaus o con Ohaus Corporation.

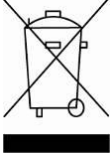
11. CONFORMIDAD

El cumplimiento con los siguientes estándares se indica por la marca correspondiente en el producto.

Marca	Estándar
	Este producto cumple con las directivas 2014/30/EU (EMC), 2014/35/EU (LVD) y 2014/31/EU (NAWI) de la Unión Europea. La declaración de conformidad de la UE está disponible en línea en www.ohaus.com/ce
	Este producto cumple con la Directiva de la UE 2012/19/CE (WEEE). Elimine este producto, según las disposiciones locales, mediante el sistema de recogida selectiva de aparatos eléctricos y electrónicos. Para consultar las instrucciones de eliminación en Europa, visite www.ohaus.com/weee .
	Este producto cumple con los estándares legales aplicables de la restricción del uso de ciertas sustancias peligrosas en las regulaciones de equipos eléctricos y electrónicos de 2012, las regulaciones de compatibilidad electromagnética del Reino Unido de 2016, las regulaciones de equipos eléctricos (seguridad) de 2016 y las regulaciones de instrumentos de pesaje no automáticos de 2016. Reino Unido La Declaración de conformidad está disponible en línea en www.ohaus.com/uk-declarations .
	EN 61326-1
	CAN/CSA-C22.2 No. 61010-1 UL Std. No. 61010-1

Aviso importante para dispositivos de pesaje verificados PX/PXP/PJX/PR...-M en la UE y Reino Unido.

Cuando el instrumento se usa en una transacción o en una aplicación controlada legalmente, este debe ser configurado, verificado y sellado de acuerdo con los reglamentos de pesos y mediciones locales. Es la responsabilidad del comprador asegurar que se cumplan todos los requisitos legales pertinentes. Los instrumentos de pesaje verificados en el lugar de fabricación deben llevar el siguiente marcado adicional de metrología en una placa descriptiva.

  1259   0126

Los instrumentos de pesaje que tiene que ser verificados en dos etapas no llevan un marcado adicional de metrología en la placa descriptiva. La segunda etapa de la evaluación de conformidad debe llevarse a cabo por las autoridades pertinentes de pesaje y de mediciones.

Si los reglamentos nacionales limitan la validez del periodo de verificación, el usuario del instrumento de pesaje debe observar estrictamente el periodo de reverificación e informar a las autoridades de pesaje y de mediciones.

Dado que los requisitos de verificación varían por jurisdicción, el comprador debe contactar a su oficina local de pesaje y de mediciones si desconoce los requisitos.

Declaración de cumplimiento con la ISED en Canadá:

Este aparato digital de Clase A cumple con el ICES-003 canadiense.

Registro de ISO 9001

El sistema de gestión que rige la producción de este producto está certificado por la norma ISO 9001.

GARANTÍA LIMITADA

Los productos Ohaus están garantizados contra defectos en los materiales y mano de obra desde la fecha de entrega y hasta que termine el período de garantía. Durante el período de garantía, Ohaus reparará, o si procede, reemplazará sin coste alguno cualquier componente o componentes que resulten ser defectuosos, siempre y cuando se devuelva el producto a Ohaus con los gastos de envío pagados por adelantado.

Esta garantía no se aplica si el producto ha sido dañado por accidente o mal uso, expuesto a materiales radioactivos o corrosivos, si algún objeto extraño entra en el interior del producto, o como resultado de haber sido modificado o prestado servicio por personas ajenas a Ohaus. Además del envío apropiado de la tarjeta de garantía, el periodo de garantía comienza en la fecha del envío al distribuidor autorizado. No existe ninguna otra garantía expresa o implícita ofrecida por Ohaus Corporation. Ohaus Corporation no puede ser demandada por daños consecuentes.

Ya que las legislaciones de garantías difieren de estado a estado y de país a país, para obtener más información póngase en contacto con su representante local de Ohaus.

Table des matières

1. INTRODUCTION	FR-3
1.1 Description	FR-3
1.2 Caractéristiques	FR-3
1.3 Définition des symboles et signes d'avertissement	FR-3
1.4 Précautions de sécurité	FR-3
2. INSTALLATION.....	FR-4
2.1 Désemballage	FR-4
2.2 Sélection de la position	FR-4
2.3 Nivellement	FR-4
2.4 Branchement de l'alimentation et acclimatation de la balance	FR-4
2.5 Branchement de l'interface	FR-5
2.6 Calibrage initial	FR-5
3. OPERATION	FR-6
3.1 Aperçu de l'affichage, de l'écran d'accueil.....	FR-6
3.2 Fonction principales et menu principal	FR-7
3.3 Aperçu des parties et des fonctions – Mode paravent	FR-7
3.4 Aperçu des pièces et des fonctions – Modèle sans paravent	FR-7
4. APPLICATIONS.....	FR-8
4.1 Pesage	FR-8
4.2 Comptage des pièces	FR-8
4.3 Pesage en pourcentage.....	FR-10
4.4 Fonctionnalités supplémentaires	FR-12
5. REGLAGES DU MENU	FR-13
5.1 Menu de navigation.....	FR-13
5.1.1 Changement des réglages.....	FR-13
5.2 Calibrage.....	FR-13
5.2.1 Sous menu de calibrage (modèles InCal).....	FR-13
5.2.2 Calibrage interne (non applicable aux modèles ExCal).....	FR-14
5.2.3 Réglage de cal (non applicable aux modèles ExCal)	FR-14
5.2.4 Calibrage de portée	FR-14
5.2.5 Calibrage de linéarité	FR-15
5.3 Réglage de la balance	FR-16
5.3.1 Niveau de filtre	FR-17
5.3.2 AZT (Mise à zéro automatique)	FR-17
5.3.3 Auto Tare	FR-17
5.3.4 Graduations	FR-17
5.3.5 Format de date.....	FR-18
5.3.6 Réglage de date.....	FR-18
5.3.7 Format de l'heure.....	FR-18
5.3.8 Réglage de l'heure.....	FR-18
5.3.9 Luminosité.....	FR-18
5.3.10 Auto Dim	FR-19
5.3.11 Mode approuvé	FR-19
5.4 Unités de pesage	FR-20
5.5 Réglage d'interface RS232	FR-21
5.5.1 Taux de bauds	FR-21
5.5.2 Transmission.....	FR-21
5.5.3 Salutations	FR-21
5.6 Réglages d'impression.....	FR-21
5.6.1 Stable uniquement	FR-21
5.6.2 Numérique uniquement	FR-21
5.6.3 En-tête unique.....	FR-21
5.6.4 Impression automatique.....	FR-21
5.6.5 En-tête.....	FR-21
5.6.6 Date et heure	FR-21
5.6.7 ID de Balance.....	FR-21

5.6.8	Nom de la balance	FR-21
5.6.9	Nom d'utilisateur	FR-21
5.6.10	Nom du projet.....	FR-21
5.6.11	Nom d'application	FR-21
5.6.12	Résultat	FR-21
5.6.13	Brut.....	FR-21
5.6.14	Net.....	FR-21
5.6.15	Tare.....	FR-21
5.6.16	Ligne d'alimentation	FR-21
5.7	GLP	FR-24
5.7.1	En-tête.....	FR-24
5.7.2	Nom de la balance	FR-24
5.7.3	Nom d'utilisateur	FR-24
5.7.4	Nom du projet	FR-24
5.8	Ré initialisation d'usine	FR-25
5.9	Se déconnecter.....	FR-25
6.	CERTIFIÉ POUR USAGE COMMERCIAL (LFT)	FR-26
6.1	Réglages	FR-26
6.2	Vérification	FR-27
6.3	Scellement	FR-27
7.	IMPRESSION	FR-28
7.1	Connexion, configuration et test de l'imprimante / Interface de l'ordinateur.....	FR-28
7.2	Format d'affichage	FR-29
7.3	Exemples imprimés.....	FR-29
8.	ENTRETIEN	FR-31
8.1	Calibrage.....	FR-31
8.2	Nettoyage.....	FR-31
8.3	Dépannage	FR-31
8.4	Renseignement sur le service	FR-32
9.	DONNÉES TECHNIQUES.....	FR-33
9.1	Spécifications.....	FR-33
9.2	Schémas et dimensions.....	FR-41
9.3	Accessoires.....	FR-42
9.4	Communication	FR-42
9.4.1	Commandes d'interface	FR-42
9.4.2	RS232 (DB9) Connexions de broche	FR-43
10.	MISE À JOUR DU LOGICIEL	FR-43
11.	CONFORMITE.....	FR-44

1. INTRODUCTION

1.1 Description

La balance PR est un instrument de mesure de précision offrant des années de service en cas d'utilisation appropriée.

Les balances PR sont disponibles en capacités allant de 62 grammes à 6200 grammes.

1.2 Caractéristiques

Contrôles d'opération: écran rétro-éclairé, avec 3 applications de pesage et plusieurs fonctionnalités.



1.3 Définition des symboles et signes d'avertissement

Les notes de sécurité sont marqués par des mots signaux et des symboles d'avertissement. Ils présentent les problèmes et avertissements de sécurité. Le non-respect des notes de sécurité pourrait déboucher sur des blessures personnelles, l'endommagement de l'appareil, les défaillances et les résultats erronés.

AVERTISSEMENT: Pour une situation dangereuse avec risque moyen, débouchant probablement sur des blessures ou la mort en cas de non évitement.

ATTENTION: Pour une situation dangereuse avec un faible risque, débouchant sur un endommagement de l'appareil, des pertes matérielles ou des données ou encore des blessures en cas de non évitement.

Attention Pour des informations importantes concernant le produit.

Remarque Pour des informations importantes concernant le produit.

Symboles d'avertissement



Risque général



Risque d'électrocution



Courant alternatif



Courant direct

1.4 Précautions de sécurité



ATTENTION: Veuillez lire tous les avertissements de sécurité avant l'installation, le branchement ou l'entretien de l'appareil. Le non-respect de ces avertissements pourrait déboucher sur des blessures personnelles et/ou des dommages matériels. Veuillez conserver toutes les instructions pour une référence ultérieure.

- Vérifier que la plage de tension d'entrée de l'adaptateur AC et le type de fiche sont compatibles avec l'alimentation secteur AC locale.
- S'assurer que le cordon d'alimentation ne constitue pas un obstacle potentiel ou un risque de trébuchement.
- Évitez de positionner la balance de telle enseigne qu'il soit difficile d'atteindre le câble d'alimentation.
- La balance est CONÇUE pour une utilisation interne uniquement. Ne pas opérer l'équipement dans des environnements dangereux ou dans des emplacements instables.
- Opérer l'équipement uniquement sous des conditions ambiantes spécifiées dans les présentes instructions.
- Évitez de laisser des charges tomber sur la base.
- Utiliser la balance uniquement dans les emplacements secs.
- Déconnecter l'équipement de l'alimentation pendant le nettoyage.
- Utiliser uniquement les accessoires et périphériques approuvés.
- Le service doit uniquement être effectué par le personnel autorisé.

2. INSTALLATION

2.1 Désemballage

Retirer soigneusement votre balance PR et chacun de ses composants de l'emballage. Les composants inclus varient en fonction du modèle de la balance. Conserver l'emballage pour assurer la sécurité du stockage et du transport. Veuillez lire entièrement le manuel avant de procéder à l'installation et à l'utilisation de la balance PR afin d'éviter une opération incorrecte.

Les composants comprennent:

- Balance
- Adaptateur d'alimentation + Fiche de raccordement
- Plateau en acier inoxydable
- Support du plateau (pour le modèle 0,1 g / 0,01 g uniquement)
- Carte de garantie

2.2 Sélection de la position

Évitez des sources de chaleur, des changements rapides de température, le courant d'air ou les vibrations excessives. Laisser un espace suffisant.

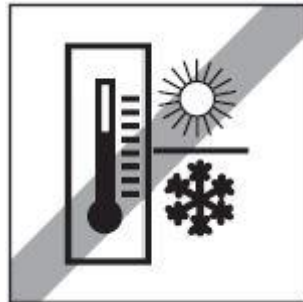

2.3 Nivellement

S'assurer que la balance est nivelée avant d'utiliser ou après le changement de position.

La balance PR a une bulle de niveau dans une fenêtre en petit rond à côté de l'affichage.

Pour niveler la balance, régler les 2 pieds de nivellement jusqu'à ce que la bulle soit centrée dans le cercle.

Veuillez vous référer à la figure de droite pour le nivellement.

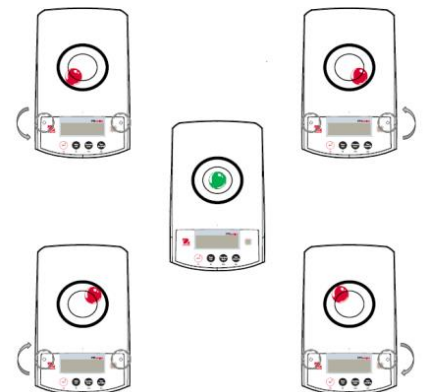

2.4 Branchement de l'alimentation et acclimatation de la balance

Brancher le connecteur de sortie DC du réceptacle d'alimentation à l'arrière de la balance. Connecter ensuite la fiche de l'adaptateur AC à une prise électrique appropriée.

Acclimatation

Il est suggéré que la balance ne soit pas utilisée tant qu'elle n'est pas acclimatée à l'environnement pendant une certaine période de temps. Si la balance a une précision dépassant 0,1 mg, le temps de pré acclimatation doit être de 1,5 heure, si la balance a une précision de 1 mg, le temps d'acclimatation doit dépasser 0,5 heure.

2.5 Branchement de l'interface

La balance PR a un port RS232.

Utiliser le port RS-232 pour connecter soit un ordinateur, soit une imprimante avec câble de série standard (direct).

Connexions d'interface sur l'arrière de la balance



RS232

RS232: Utilisé pour connecter le PC ou l'imprimante.

Remarque: Consulter la section d'impression pour la connexion, la configuration et le test de l'imprimante/l'interface de l'ordinateur.

2.6 Calibrage initial

Lors de la première installation de la balance PR, ou lorsqu'elle est déplacée dans une autre position, elle doit être calibrée afin de s'assurer des résultats de pesage précis. Les balances PR sont classifiées en deux catégories notamment les modèles InCal et ExCal. Les modèles InCal ont un mécanisme de calibrage intégré capable de calibrer automatiquement la balance et ne nécessite pas l'utilisation des masses de calibrage externe. Si préféré, les modèles InCal doivent être manuellement calibrées avec des masses externes. Les modèles ExCal sont calibrés avec des masses externes. S'assurer d'avoir des masses de calibrage disponible avant le début du calibrage.





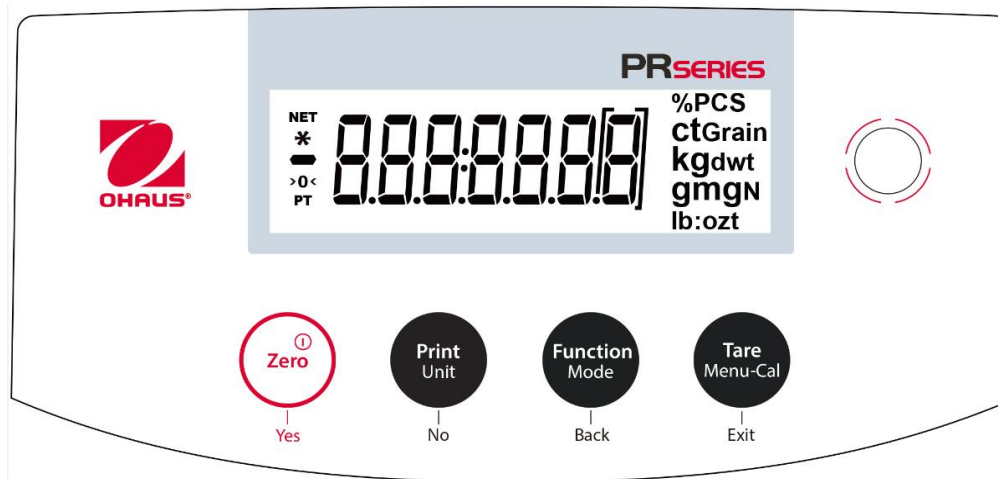

3. OPERATION

3.1 Aperçu de l'affichage, de l'écran d'accueil

CONTROLES



FONCTIONS DE CONTROLE

Bouton	 Yes	 No	 Back	 Exit
Fonction primaire (Appuyer légèrement) 	Marche/Zéro <ul style="list-style-type: none"> • Si l'indicateur est éteint, allumer l'indicateur. • Si l'indicateur est allumé, régler à zéro. 	Imprimer <ul style="list-style-type: none"> • Envoie la valeur de l'affichage actuel à l'interface de série. 	Fonction <ul style="list-style-type: none"> • L'opération dépend du mode d'application. 	Tare <ul style="list-style-type: none"> • Effectue l'opération tare.
Fonction secondaire (Appuyer et maintenir) 	Éteint <ul style="list-style-type: none"> • Mise à zéro de la valeur actuelle. 	Unité <ul style="list-style-type: none"> • Change les unités de pesage. 	Mode <ul style="list-style-type: none"> • Change le mode d'application. 	Menus-Cal <ul style="list-style-type: none"> • Entre dans le menu principal. Le calibrage est dans le premier sous menu. • Voir la valeur tare pré-réglée.
Menu de fonction (Appuyer légèrement) 	Oui <ul style="list-style-type: none"> • Accepte le réglage actuel (clignotement) sur l'affichage. 	Non <ul style="list-style-type: none"> • Rejette le réglage actuel (clignotement) sur l'affichage. • Augmente la valeur entrée. 	Retour <ul style="list-style-type: none"> • Retourne à l'élément du menu précédent. • Réduit la valeur entrée. 	Quitter <ul style="list-style-type: none"> • Quitter immédiatement le sous menu. • Annuler le calibrage en cours.

ECRAN PRINCIPAL D'APPLICATION



3.2 Fonction principales et menu principal

- Pesage:** Appuyer premièrement sur **Zéro** pour régler l'affichage à zéro. Placer un objet sur le plateau. L'affichage indique le poids brut.
- Tarage:** Sans charge sur le plateau, appuyer sur **Zéro** pour régler l'affichage à zéro. Placer un récipient vide sur le plateau et appuyer sur **Tare**. Ajouter des objets sur le récipient et son poids net s'affiche. Une fois le récipient et les objets retirés, la charge affichera un numéro négatif. Appuyer sur **Tare** pour effacer.
- Zéro:** Appuyer sur **Zéro** pour mettre la balance à zéro.

3.3 Aperçu des parties et des fonctions – Mode paravent

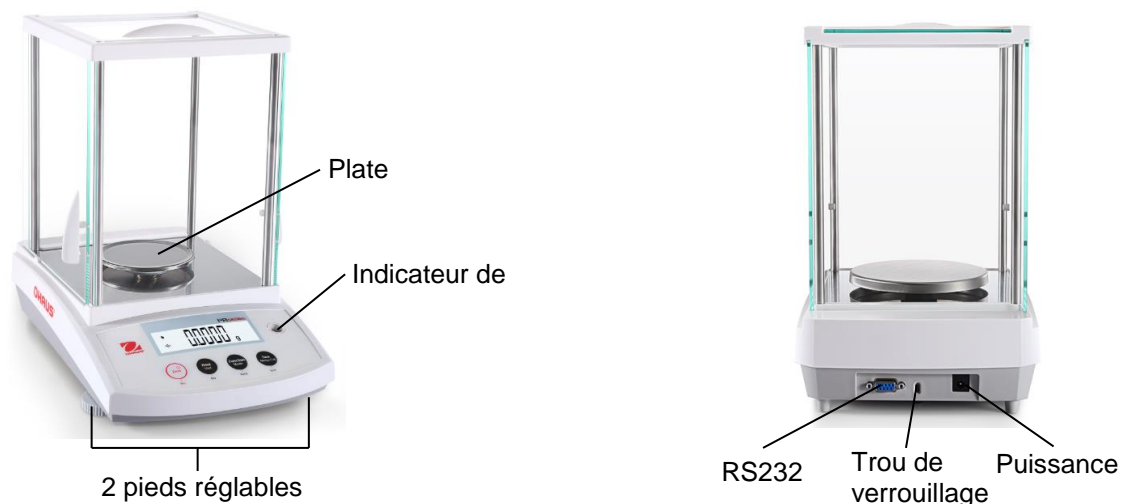

3.4 Aperçu des pièces et des fonctions – Modèle sans paravent

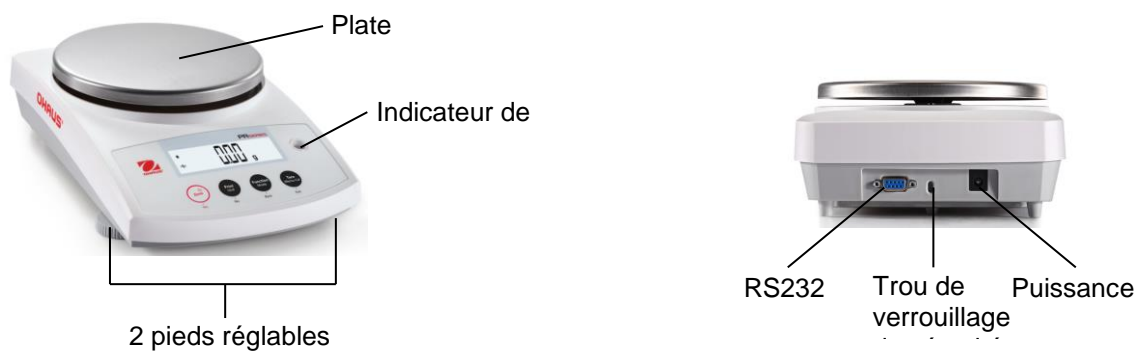

4. APPLICATIONS



La balance PR pourrait être opérée dans 3 modes d'application en appuyant longuement sur le bouton **Fonction / Mode**.

4.1 Pesage

Remarque: Avant d'utiliser toute application, s'assurer que la balance est nivelée et calibrée.

Utiliser cette application pour déterminer le poids des éléments dans l'unité sélectionnée de mesure.

Pesage

<ol style="list-style-type: none"> Appuyer sur Tare ou Zéro si nécessaire pour commencer. Appuyer et maintenir le bouton Fonction / Mode pour sélectionner le POIDS (cette application est par défaut). 	
<ol style="list-style-type: none"> Placer les objets sur le plateau pour afficher le poids. Une fois la lecture stable, * s'affiche. La valeur résultante s'affiche dans l'unité active de mesure. 	

Réglages d'élément

Pour voir ou ajuster les réglages actuels.

- **Unités de pesage:** Changer l'unité affichée. Voir la Section 5.4 pour les processus détaillés.
- **Niveau de filtre:** Changer le niveau de filtrage. Consulter la section 5.3.2 pour des informations supplémentaires.
- **Données GLP:** Consulter la section 5.7 pour des informations supplémentaires.
- **Réglages d'impression:** Changer les réglages d'impression. Consulter la section 7 pour des informations supplémentaires.





4.2 Comptage des pièces

Remarque: Avant d'utiliser toute application, s'assurer que la balance est nivelée et calibrée. Le poids minimal de la pièce ne doit pas être inférieur à 0,1d. En mode LFT, le poids minimum à la pièce est de 3e, la taille minimale de l'échantillon est de 10.

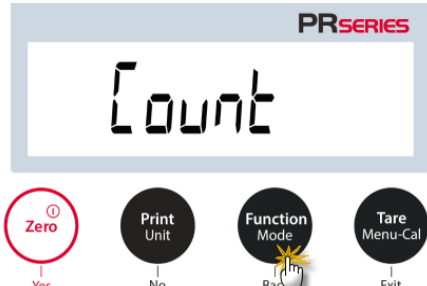
Utiliser cette application pour compter les échantillons du poids uniforme.

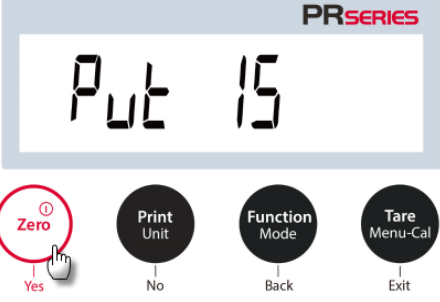
Comptage des pièces

<ol style="list-style-type: none"> Appuyer sur Tare ou Zéro si nécessaire pour commencer. Appuyer et maintenir le bouton Fonction / Mode jusqu'à ce que le décompte apparaisse. 	
--	--

<p>3. Après la confirmation en appuyant sur Oui, le message CLr.APW s'affiche à l'écran.</p>	
<p>4. Appuyer sur Oui, et le message entrer 10 s'affiche avec le numéral 10 (défaut) clignotant. L'utilisateur pourrait appuyer sur Non ou Oui pour augmenter ou diminuer la valeur. Pour augmenter précisément la valeur de 15, veuillez appuyer sur Oui. Ensuite, mettre et 15 clignotera simultanément.</p>	
<p>4. Placer 15 échantillons sur le plateau. Appuyer sur le bouton Fonction / Mode de telle enseigne que les 15 échantillons soient utilisés pour établir un poids moyen (APW). L'affichage présente 15 pièces.</p>	
<p>5. Retirer les 15 échantillons du plateau et y placer les échantillons supplémentaires. Le nombre de pièces correspondantes s'affiche à l'écran.</p>	
<p>6. Pour voir le poids total ou le nombre de pièces des objets, appuyer sur le bouton Fonction / Mode.</p>	

Réglages d'élément

Pour voir ou ajuster les réglages actuels.

Échantillons: La taille d'échantillon varie de 1 à 100. La valeur par défaut est 10.

Remarque: Si APW des dernières parties de l'opération de comptage doit être maintenu, l'utilisateur pourrait appuyer sur **Non** lorsque l'affichage présente le message **CLR.APW CLEAR LE Poids Moyen DE LA PEE** Placer des objets supplémentaires sur le plateau et le numéro correspondant des pièces s'affichera.

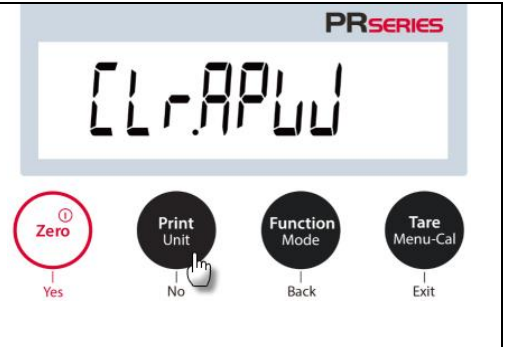
**Optimisation APW:**

L'amélioration de la précision du décompte par le recalcul automatique du poids des pièces comme parties sont ajoutés.

L'optimisation APW survient uniquement lorsque le nombre de pièces ajoutées au plateau est entre un et trois fois le nombre déjà présent sur le plateau.

Réglages d'impression:

Changement des réglages d'impression. Consulter la section 7 pour des informations supplémentaires.

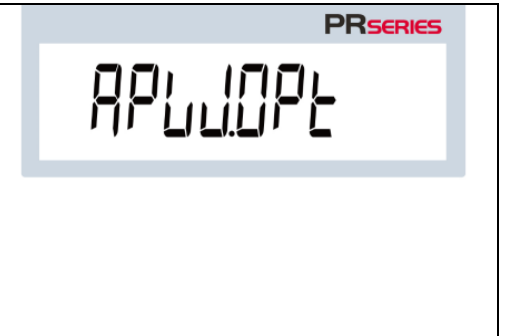
**4.3 Pesage en pourcentage**

Remarque: Avant d'utiliser toute application, s'assurer que la balance est nivelée et calibrée.





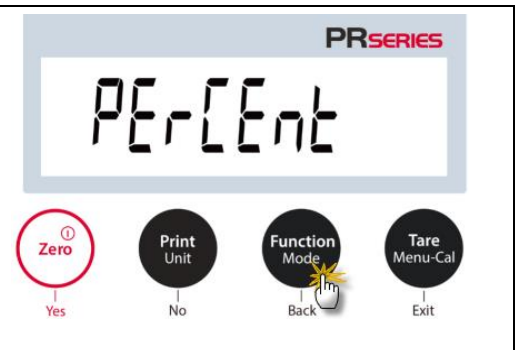

Utiliser le pesage en pourcentage pour afficher le poids d'un objet de test comme pourcentage d'un échantillon de référence pré établi.

Le poids de référence par défaut (ou le dernier) s'affiche.

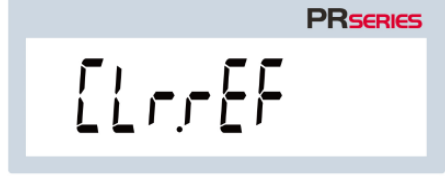
Pesage en pourcentage

1. Appuyer et maintenir le bouton **Fonction / Mode** jusqu'à ce que Pourcentage s'affiche.



<p>2. Après la confirmation en appuyant sur Oui, le message Clr.rEF (effacer la référence) s'affiche à l'écran.</p>	 <p>The display shows 'Clr.rEF' in a large digital font. Below the display are four buttons: 'Zero' (circled in red), 'Print Unit', 'Function Mode', and 'Tare Menu-Cal'. Below each button is a label: 'Yes', 'No', 'Back', and 'Exit' respectively. A mouse cursor is pointing at the 'Zero' button.</p>
<p>3. Appuyer sur Oui, et mettre rEF (mettre le poids de référence) s'affiche.</p>	 <p>The display shows 'PUL.rEF' in a large digital font. Below the display are four buttons: 'Zero' (circled in red), 'Print Unit', 'Function Mode', and 'Tare Menu-Cal'. Below each button is a label: 'Yes', 'No', 'Back', and 'Exit' respectively. A mouse cursor is pointing at the 'Function Mode' button.</p>
<p>4. Placer l'échantillon de référence sur le plateau pour afficher le poids. Une fois la lecture stable, * s'affiche. 5. Appuyer sur le bouton Fonction / Mode afin que le poids des échantillons de référence soit stocké dans la mémoire. L'affichage présente 100.0000%.</p>	 <p>The display shows '*' on the left and '100.0000%' on the right. Below the display are four buttons: 'Zero' (circled in red), 'Print Unit', 'Function Mode', and 'Tare Menu-Cal'. Below each button is a label: 'Yes', 'No', 'Back', and 'Exit' respectively. A mouse cursor is pointing at the 'Function Mode' button.</p>
<p>6. Retirer l'échantillon de référence et placer l'objet de test sur le plateau. Le rapport de l'objet du test au poids de l'échantillon de référence s'affiche comme pourcentage.</p>	 <p>The display shows '*' on the left and '50.0000%' on the right. Below the display are four buttons: 'Zero' (circled in red), 'Print Unit', 'Function Mode', and 'Tare Menu-Cal'. Below each button is a label: 'Yes', 'No', 'Back', and 'Exit' respectively. A mouse cursor is pointing at the 'Function Mode' button.</p>
<p>7. Pour afficher le poids de l'échantillon de référence ou le pourcentage du poids de l'objet de test, appuyer sur le bouton Fonction / Mode.</p>	 <p>The display shows '100.0000 g' in a large digital font. Below the display are four buttons: 'Zero' (circled in red), 'Print Unit', 'Function Mode', and 'Tare Menu-Cal'. Below each button is a label: 'Yes', 'No', 'Back', and 'Exit' respectively. A mouse cursor is pointing at the 'Function Mode' button.</p>
<p>8. Pour établir un nouveau poids d'échantillon de référence, appuyer longuement sur le bouton Fonction / Mode et répéter les étapes décrites plus haut.</p>	 <p>The display shows 'PERCENT' in a large digital font. Below the display are four buttons: 'Zero' (circled in red), 'Print Unit', 'Function Mode', and 'Tare Menu-Cal'. Below each button is a label: 'Yes', 'No', 'Back', and 'Exit' respectively. A mouse cursor is pointing at the 'Function Mode' button.</p>

Réglages d'élément

Remarque: Si le poids de référence de l'opération de pesage du dernier pourcentage doit être maintenu, appuyer sur **Non** lorsque le message **REF** (effacer la référence) s'affiche.

**Réglage d'impression:**

Changement des réglages d'impression. Consulter la section 7 pour des informations supplémentaires.

4.4 Fonctionnalités supplémentaires**Peser en deça**

Remarque: S'assurer que la balance a été nivelée et calibrée.

La balance PR est équipée avec un poids en dessous du crochet pour le pesage en dessous de la balance (tel qu'indiqué ci-dessus).

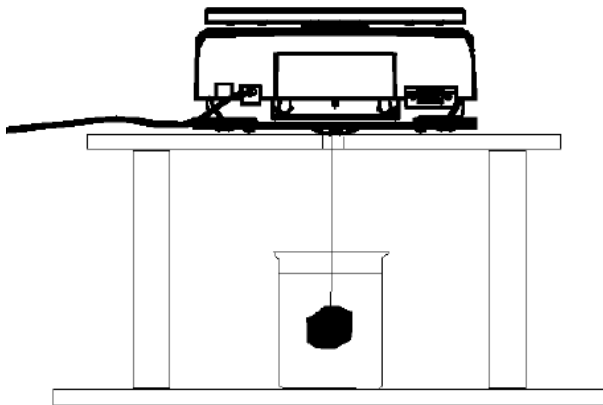

Avant de déposer la balance, retirer le plateau et les éléments du paravent (si présent) pour empêcher les dommages. Ne pas placer la balance sur le cône de support du plateau ou les broches de la cellule de charge.

Pour utiliser cette fonctionnalité, couper l'alimentation de la balance et retirer le couvercle de protection pour l'ouverture du pesage ci-dessous.

Alimenter la balance et utiliser un fil ou une corde pour attacher les éléments à peser.



Peser en dessous du couvercle de protection.



Peser en dessous

5. REGLAGES DU MENU

5.1 Menu de navigation

Calibrage	Réglage	Unité	RS232	Imprimer	GLP	Réinitialiser	Verrouiller	
InCal	Niveau de filtre	Gramme	Taux de bauds	Stable uniquement	En-tête 1	Tout réinitialiser	Calibrage	
Réglage Cal	AZT	Kilogramme	Parité	Numérique uniquement	En-tête 2		Réglage	
Portée Cal	Auto Tare	Milligramme	Salutations	En-tête unique	En-tête 3		RS232	
Linéarité Cal	Graduations	Carat		Impression automatique	Nom de la balance		Imprimer	
	Format de date	Pound		En-tête	Nom d'utilisateur		GLP	
	Réglage de date	Once		Date et heure	Nom du projet		Réinitialiser	
	Format du temps	Ounce Troy		ID de Balance				
	Réglages d'heure	Penny Weight *		Nom de la balance				
	Luminosité	Newton		Nom d'utilisateur				
	Auto Dim	Grain		Nom du projet				
	LFT	TW Tael		Nom d'application				
		Custom 1		Résultat				
				Poids brut				
			Poids net					
			Poids de tare					
			Ligne de signature					
			Ligne d'alimentation					

* Penny weight is not available for NTEP model.

Remarque: Les balances PR sont classifiées en modèles InCal et ExCal.

5.1.1 Changement des réglages

Pour changer un réglage de menu, naviguer dans ce réglage en suivant les étapes suivantes:

Entrer dans le menu

Appuyer longuement sur le bouton du menu pour entrer dans le **Menu**.

Sélectionner le sous menu

Appuyer sur **Non** pour naviguer entre les sous menus, et appuyer sur **Oui** pour entrer dans le sous menu.

Sélectionner l'élément du menu

Appuyer sur **Non** pour naviguer entre les éléments du menu, et appuyer sur **Oui** pour entrer dans l'élément du menu affiché.

5.2 Calibrage

Les balances PR offrent un choix de trois méthodes de calibrage: Le calibrage interne (pour les modèles InCal uniquement), le calibrage de portée et le calibrage de linéarité.

Attention: Évitez de perturber la balance pendant le calibrage.

5.2.1 Sous menu de calibrage (modèles InCal)

Remarque: Les modèles ExCal sont dotées uniquement du calibrage de portée et du calibrage de la linéarité.

5.2.2 Calibrage interne (non applicable aux modèles ExCal)

Le calibrage s'effectue avec la masse de calibrage interne. Le calibrage interne pourrait être effectué à tout moment, à condition que la balance soit chauffée à la température d'opération et nivelée.

Avec la balance en marche et sans change sur le plateau, le calibrage interne pourrait être effectué. Appuyez sur le bouton **Tare / Menu-Cal** pour entrer dans le paramètre d'étalonnage interne. Alternativement, appuyer sur le bouton **Tare / Menu-Cal** et sélectionner **InCAL** pour initier un calibrage interne.

Définir la fonctionnalité de calibrage interne		InCAL calibrage interne
Marche = Activé Arrêt = désactivé InCAL = initier un calibrage interne		
ON Marche	OFF Arrêt	InCAL calibrage interne

L'écran affiche le statut, et appuyer sur n'importe quelle touche pour retourner dans l'écran précédent.

5.2.3 réglage de cal (non applicable aux modèles ExCal)

Utiliser cette méthode de calibrage pour affiner l'effet du calibrage interne.

Le réglage de calibrage pourrait être utilisé pour ajuster le résultat du calibrage interne de ± 100 divisions.

Remarque: Avant d'effectuer un ajustement de calibrage, effectuer un calibrage interne. Pour vérifier si le réglage est nécessaire, placer un test de masse égale à la **valeur du calibrage du zéro** sur le plateau et noter la différence (en divisions) entre la valeur de masse nominale et la lecture de balance actuelle. Si la différence est entre la division +/-, le réglage de calibrage n'est pas nécessaire. Si la différence dépasse la division +/-, le réglage de calibrage est recommandé.

Exemple:

Lecture du poids prévu:	200,000 (Valeur de test de la masse)
Lecture du poids réel:	200,014
Différence en gramme:	- 0,014
Différence dans la division:	- 14 (Valeur de réglage InCal)

Pour effectuer le réglage de calibrage, sélectionner le réglage InCal dans la liste du menu de calibrage, entrer la valeur (divisions positive ou négative) pour correspondre entre la différence remarquée plus tôt dans la procédure.





Calibrer à nouveau en utilisant le calibrage interne. Après le calibrage, placer le test de masse sur le plateau et vérifier que la valeur de la masse correspond à la valeur affichée. Dans le cas contraire, répéter la procédure jusqu'à ce que la lecture de calibrage interne corresponde avec le test de masse. Une fois terminé, la balance enregistre la valeur de réglage et l'affichage retourne à l'application actuelle.

5.2.4 Calibrage de portée

Le calibrage de portée utilise deux points de calibrage, un à la **charge zéro** et l'autre à la **charge total spécifiée** (portée). Pour des informations de masse de calibrage détaillé, se référer aux tableaux de spécifications dans les « Points de calibrage de portée », SPECIFICATIONS, Section 9.

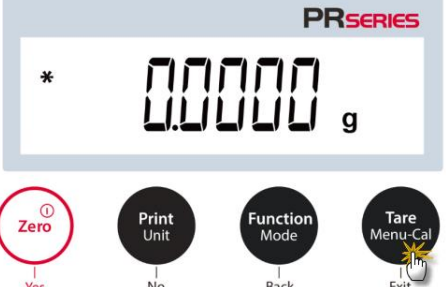
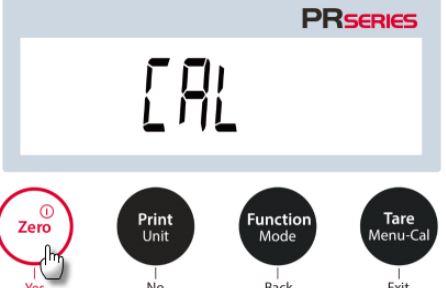
Avec la balance en marche et sans change sur le plateau, le calibrage de portée pourrait être effectué. Les valeurs du calibrage supplémentaire à utiliser sont affichées. La meilleure fiabilité est effectuée en utilisant la masse la plus proche de la valeur de portée entière.

Étapes pour le calibrage de portée

<p>1. Appuyer et maintenir la touche Tare / Menu-Cal, et le menu de calibrage s'affiche.</p>	
<p>2. Appuyer sur Oui pour entrer dans le menu de calibrage.</p>	
<p>3. Pour changer le mode de calibrage, appuyer sur Non jusqu'à ce que Portée (calibrage de portée) s'affiche.</p>	
<p>1. La valeur des masses de calibrage seront affichées sur l'écran. Une fois que l'affichage présente 200.0000 g, veuillez placer les poids de 200 g sur le plateau pour le calibrage. Pour changer le point de calibrage de la capacité à moitié, (exemple 100g) appuyer sur la touche Fonction / Mode. Si 0,0000 g s'affiche, veuillez retirer la masse.</p>	
<p>2. Une fois le calibrage de portée effectué avec succès, CAL s'affiche. Appuyer sur n'importe quelle touche pour retourner dans l'écran précédent.</p>	
<p>3. Retirer le poids et la lecture sera réglée à zéro.</p>	

5.2.5 Calibrage de linéarité







Le calibrage de linéarité utilise trois points de calibrage, un à la charge zéro et les autres aux charges spécifiées.

Sans charge sur l'échelle, appuyer sur le calibrage de linéarité pour commencer le processus.

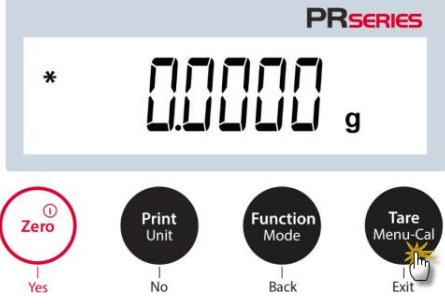
La balance capture le point zéro, et se prépare pour le prochain pesage.

Continuer à suivre les instructions qui s'affichent jusqu'à ce que le calibrage soit effectué.

Étapes pour le calibrage de linéarité

<p>1. Appuyer et maintenir la touche Tare / Menu-Cal, et le menu de calibrage s'affiche.</p>	
<p>2. Appuyer sur Oui pour entrer dans le menu de calibrage.</p>	
<p>3. Pour changer le mode de calibrage, appuyer sur Non jusqu'à ce que LineRr (calibrage de portée) s'affiche.</p>	
<p>4. La valeur des masses de calibrage seront affichées sur l'écran. Une fois que l'affichage présente 100.0000 g, veuillez placer les poids de 100 g sur le plateau pour le calibrage.</p>	
<p>5. Retirer le poids de 100 g sur le plateau. Après un certain temps, 200.0000 g s'affiche à l'écran. Veuillez placer le poids de 200 g sur le plateau.</p>	
<p>6. Une fois le calibrage de linéarité effectué avec succès, CAL s'affiche. Appuyer sur n'importe quelle touche pour retourner dans l'écran précédent.</p>	
<p>7. Retirer le poids et la lecture sera réglée à zéro.</p>	

5.3 Réglage de la balance

Entrer dans le sous menu pour personnaliser la fonctionnalité de balance.

Remarque: Les réglages d'usine par défaut s'affichent ci-dessous en **gras**.

5.3.1 Niveau de filtre

Régler la quantité du signal de filtrage.		F I L T E R
Faible = accélère le temps de stabilisation avec moins de stabilité. Moyen = temps de stabilisation normale avec la stabilité normale. Élevé = réduit le temps de stabilisation avec moins de stabilité.		
LoW Faible	MEd Moyen	HIGH Élevé

5.3.2 AZT (Mise à zéro automatique)

Régler la fonctionnalité de mise à zéro automatique		AZT Mise à zéro automatique
Arrêt = Désactivé 0,5d = l'affichage reste à zéro jusqu'à ce que 0,5 s'affiche graduellement par seconde. 1d = l'affichage reste à zéro jusqu'à ce que 1 s'affiche graduellement par seconde. 3d = l'affichage reste à zéro jusqu'à ce que 3 s'affiche graduellement par seconde.		
0.5 d 0,5 d	1 d 1 d	3 d 3 d

5.3.3 Auto Tare

Régler tare automatiquement		
Lorsque tare automatique est réglé sur Marche, le premier objet placé sur le plateau sera considéré comme récipient et la tare sera automatique. Arrêt = désactivé. Marche = Activé		
A.T.A-E Auto Tare	OFF Arrêt	ON Marche

5.3.4 Graduations

Régler la lecture affichée sur la balance.		
1 Division = lisibilité standard. 10 Divisions = la lisibilité est augmentée par le facteur 10. A titre d'exemple, si la lisibilité standard est 0,01 g, la sélection de 10 divisions débouchera sur une lecture de 0,1 g.		
GrAd Graduation	1 d 1 Division	10 d 10 Division

5.3.5 Format de date

Régler le format de date actuel. Format de date: AA/MM/JJ MM/JJ/AA JJ/MM/AA	d.Fo.r.m.àt.e Format de date	m.m.j.j. MM/JJ/AAAA
	j.j.m.m. JJ/MM/AAAA	à.à.à.à. AAAA/MM/JJ

5.3.6 Réglage de date

Régler la date actuelle dans le format de date souhaitée. Pour régler la date actuelle, appuyer sur Non ou Oui pour augmenter ou diminuer la valeur.	d.a.t.e Date
A titre d'exemple, si la date actuelle est le 22 juin 2017, MM/JJ/AA: 06.22.17 JJ/MM/AA: 22.06.17 AA/MM/JJ: 17.06.22	06.22.17

5.3.7 Format de l'heure

Régler le format de l'heure. Format de l'heure: 24hr 12hr		
t.Fo.r.m.àt.e Format de l'heure	24 hr 24hr	12 hr 12hr

5.3.8 Réglage de l'heure

Régler l'heure actuelle dans le format de date souhaitée.	t. h. m. s. t. h. m. s.
Pour régler l'heure actuelle, appuyer sur Non ou Oui pour augmenter ou diminuer la valeur.	08.00.00

5.3.9 Luminosité

Régler la luminosité de l'affichage. Moyen Élevé Faible	b.r. i.g.h.t. Luminosité	m.à.d. Moyen
	H I G H Élevé	L o w Faible

5.3.10 Auto Dim

Régler si la balance éteint automatiquement le rétro éclairage de l'affichage.	Aut.d 07	
Arrêt = désactivé. 10 minutes = devient dim s'il n'y a pas de mouvement pendant 10 minutes. 20 minutes = devient dim s'il n'y a pas de mouvement pendant 20 minutes. 30 minutes = devient dim s'il n'y a pas de mouvement pendant 30 minutes.		
10 07.0	20 07.0	30 07.0
10 min	20 min	30 min

5.3.11 Mode approuvé

Utiliser ce menu pour régler le légal pour le statut de vente. OFF = opération standard. ON = L'opération est conforme avec les régulations de métrologie légale.	LFe
--	-----

Pour les modèles PRxxxN :

Utiliser ce menu pour régler le légal pour le statut de vente. OFF = opération standard. ON 1D = L'opération est conforme avec les régulations de métrologie légale, e=1d. ON 10D = L'opérations est conforme avec les régulations de métrologie légale, e=10d.	LFe
---	-----

Remarque: Lorsque le mode approuvé est réglé sur Marche, les réglages de menu sont affectés de la manière suivante:

Menu de calibrage:

- Pour les modèles InCal, uniquement le calibrage interne est disponible. Toutes les autres fonctions sont cachées.

Menu de réglage de la balance:

- Le niveau de filtre est bloqué au réglage actuel.
- La remise à zéro automatique est limitée à la division 0,5 et éteint. Le réglage sélectionné est verrouillé.
- Auto tare est verrouillé au réglage actuel.
- Les graduations sont forcées à la division 1 et l'élément du menu est caché.

Menu de communication (Communication->Réglages d'impression->Impression):

- Le poids stable est uniquement verrouillé.
- La valeur numérique est verrouillée.

Menu de communication (Communication->Réglages d'impression->Impression auto):

- Les sélections de mode d'impression auto sont limités à arrêt, la stabilité est active et l'intervalle. La continuité n'est pas disponible.

Menu de déconnexion:

- Le menu est caché

5.4 Unités de pesage

Entrer dans le sous menu pour activer les unités désirées pour mesurer.



Les balances PR fournissent un choix de 12 unités, qui sont tous réglables sur Activés par défaut.

Remarque: En raison des lois nationales, la balance ne pourrait pas inclure certaines des unités de mesure listées ci-dessous.

Modèle NTEP: Le menu des unités permet d'activer ou de désactiver une unité spécifique. (SET ON, SET OFF).

Unité	Affichage
Gramme	g
Kilogramme	kg
Milligramme	mg
Carat	ct
Pound	lb
Once	oz
Ounce Troy	ozt
Penny weight	dwt
Newton	N
TW Tael	t
Custom 1	C
Grain	GN

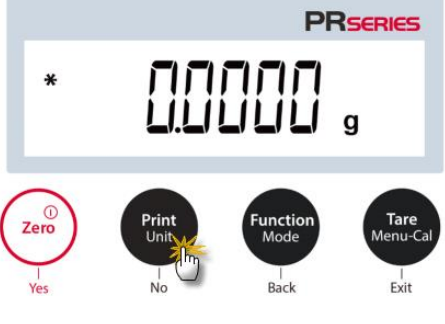
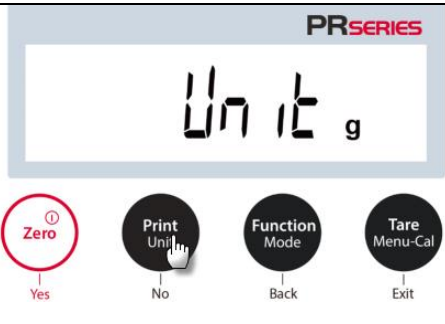
Changement des unités de pesage

<p>1. Appuyer et maintenir la touche Imprimer / Unité jusqu'à ce que le menu d'unité s'affiche.</p>	
<p>2. L'unité par défaut est le gramme (g). Pour changer l'unité, appuyer sur Non pour passer à l'unité suivante.</p>	
<p>3. Appuyer sur Oui pour régler l'unité affichée dans l'unité de pesage.</p>	

5.5 Réglage d'interface RS232

Entrer dans le sous menu pour personnaliser les réglages standard RS232. Les données pourraient être lues sur une imprimante ou sur un PC.

r-5232

5.5.1 Taux de bauds

Régler le taux de bauds (bits par seconde).

bAud

1200 = 1200 bps
 2400 = 2400 bps
 4800 = 4800 bps
9600 = 9600 bps
 19200 = 19200 bps
 38400 = 38400 bps

5.5.2 Transmission

Régler les bits de données, les bits d'arrêt et la parité.

8-N-1 = 8 bits de données, aucune parité, bit d'arrêt 1

8-N-2 = 8 bits de données, aucune parité, bit d'arrêt 2

7-E-1 = 7 bits de données, parité égale, bit d'arrêt 1

7-E-2 = 7 bits de données, parité égale, bit d'arrêt 2

7-N-1 = 7 bits de données, aucune parité, bit d'arrêt 1

7-N-2 = 7 bits de données, aucune parité, bit d'arrêt 2

7-O-1 = 7 bits de données, parité inégale, bit d'arrêt 1

7-O-2 = 7 bits de données, parité inégale, bit d'arrêt 2

PAR-ITY

Parité

8-N-1

8-N-2 = 8 bits de données, bit d'arrêt 1

5.5.3 Salutations

Régler la méthode de contrôle du flux.

AUCUN = Pas de salutation

XON-XOFF = XON/XOFF salutations

HARDWARE = logiciel de salutation

H.SHAPE

Salutations

NONE

Aucun

ON-OFF

Xon / Xoff

HARDWARE

Matériel

5.6 Réglages d'impression

Entrer dans le sous menu pour personnaliser les réglages de transfert des données.

Pr int

5.6.1 Stable uniquement

<p>Arrêt = Les valeurs sont imprimées immédiatement sans tenir compte de la stabilité. Marche = Les valeurs imprimées sont uniquement imprimés lorsque les critères de stabilité sont respectés.</p>	<p>StABLE</p>
--	---------------

5.6.2 Numérique uniquement

<p>Arrêt = Tous les résultats sélectionnés sont imprimés. Marche = Uniquement les valeurs de données numériques sont imprimées.</p>	<p>NUM</p>
---	------------

5.6.3 En-tête unique

<p>Arrêt = Les en-têtes seront imprimées pour chaque exigence d'impression. Marche = Les entêtes seront imprimées une fois par jour.</p>	<p>5 in.HEAD</p>
--	------------------

5.6.4 Impression automatique

<p>Activer ou désactiver la fonctionnalité d'impression auto, et régler le mode d'impression auto spécifique.</p>	<p>A.Pr int</p>
---	-----------------

<p>1. Arrêt = Désactivé</p>	<p>OFF</p>
------------------------------------	------------

<p>2. Stabilité activée Les valeurs imprimées sont uniquement imprimés lorsque les critères de stabilité sont respectés.</p>	<p>ON.StAb</p>
---	----------------

<p>Lorsque la stabilité active est sélectionnée, régler les conditions pour l'impression. Charge = Imprime lorsque la charge affichée est stable.</p>	<p>LoAd</p>
---	-------------

<p>Charge et zéro = Imprime lorsque la lecture de la charge affichée et zéro est stable.</p>	<p>LoAd.zEr</p>
--	-----------------

<p>3. Intervalle d'impression = Les impressions surviennent dans l'intervalle de temps défini. Lorsque l'intervalle d'impression est sélectionnée, régler l'intervalle d'heure en utilisant le clavier numérique. Remarque: Les réglages de 1 à 3600 secondes sont disponibles. Le défaut est 0.</p>	<p>IntEr</p>
---	--------------

4. Continu = les impressions continuent normalement.	Cont inu
---	----------

5.6.5 En-tête

Marche = l'en-tête est imprimée. Arrêt = l'en-tête n'est pas imprimée.	HEAdEr
---	--------

5.6.6 Date et heure

Marche = La date et l'heure sont imprimées. Arrêt = La date et l'heure ne sont pas imprimées.	dEtT
--	------

5.6.7 ID de Balance

Marche = ID de balance est imprimé. Arrêt = ID de balance n'est pas imprimé.	bAL id
---	--------

5.6.8 Nom de la balance

Marche = le nom de la balance est imprimé. Arrêt = Le nom de la balance n'est pas imprimé.	bAL.NAmT
---	----------

5.6.9 Nom d'utilisateur

Marche = le nom d'utilisateur est imprimé. Arrêt = Le nom d'utilisateur n'est pas imprimé.	USr.NAmT
---	----------

5.6.10 Nom du projet

Marche = le nom de projet est imprimé. Arrêt = Le nom de projet n'est pas imprimé.	PrJ.NAmT
---	----------

5.6.11 Nom d'application

Marche = le nom d'application est imprimé. Arrêt = Le nom d'application n'est pas imprimé.	APP.NAmT
---	----------

5.6.12 Résultat

Marche = le résultat de pesage est imprimé. Marche = le résultat de pesage n'est pas imprimé.	rESULT
---	--------

5.6.13 Brut

Marche = le poids brut est imprimé. Marche = le poids brut n'est pas imprimé.	Gross
---	-------

5.6.14 Net

Marche = le poids net est imprimé. Marche = le poids net n'est pas imprimé.	NET
---	-----

5.6.15 Tare

Marche = le poids tare est imprimé. Marche = le poids tare n'est pas imprimé.	TARE
---	------

5.6.16 Ligne de signature

Marche = la ligne de signature est imprimée. Arrêt = la ligne de signature n'est pas imprimée.	SIGN. IN
--	----------

5.6.17 Ligne d'alimentation

1 Ligne = déplacer le papier vers le haut à une ligne après l'impression. 4 Lignes = déplacer le papier vers le haut à quatre lignes après l'impression.	FEED
1 Ligne 1 ligne	4 Lignes 4 lignes

5.7 GLP

Entrer dans ce menu pour configurer les bonnes pratiques de laboratoire (BPL)	GLP
---	-----

5.7.1 En-tête

<p>Active l'impression des entêtes de BPL. Il y a trois en-têtes disponibles.</p> <p>Les réglages alphanumériques atteignent jusqu'à 16 caractères disponibles pour chaque réglage d'en-tête.</p>	<p style="text-align: center;">HEAdEr 1</p> <p style="text-align: center;">En-tête 1</p>
<p style="text-align: center;">HEAdEr 2</p> <p style="text-align: center;">En-tête 2</p>	<p style="text-align: center;">HEAdEr 3</p> <p style="text-align: center;">En-tête 3</p>

5.7.2 Nom de la balance

<p>Régler le nom de la balance</p> <p>Les réglages alphanumériques atteignent jusqu'à 16 caractères disponibles pour chaque réglage d'en-tête.</p>	<p style="text-align: center;">bAL.NA??</p>
--	--

5.7.3 Nom d'utilisateur

<p>Régler le nom d'utilisateur</p> <p>Les réglages alphanumériques atteignent jusqu'à 16 caractères disponibles pour chaque réglage d'en-tête.</p>	<p style="text-align: center;">USr.NA??</p>
--	--

5.7.4 Nom du projet

<p>Régler le nom d'utilisateur</p> <p>Les réglages alphanumériques atteignent jusqu'à 16 caractères disponibles pour chaque réglage d'en-tête.</p> <p>Le défaut est vide.</p>	<p style="text-align: center;">P-rJ.NA??</p>
---	---

5.8 Ré initialisation d'usine

<p>Utiliser ce sous menu pour réinitialiser tous les réglages de menu à leurs réglages d'usine par défaut.</p> <p>Tout réinitialiser: réinitialise tous les menus à leurs réglages d'usine par défaut.</p> <p>Quitter = retourne à l'écran principal d'application sans réinitialiser les menus.</p>	<p style="text-align: center;">RESEt</p>
---	---

5.9 Se déconnecter

<p>Utiliser ce sous menu pour verrouiller/déverrouiller certains menus.</p> <p>Arrêt = le menu est déverrouillé</p> <p>Marche = le menu est verrouillé.</p>	<p style="text-align: center;">LOcK</p>
---	--

6. CERTIFIÉ POUR USAGE COMMERCIAL (LFT)

Lorsque l'indicateur est utilisé dans le commerce ou dans une application légalement contrôlée, elle doit être configurée, vérifiée et scellée conformément aux règlements de mesure et poids locaux. L'acheteur doit s'assurer que toutes les **exigences légales pertinentes** sont respectées.

6.1 Réglages

Avant la vérification et le scellement, effectuez les étapes suivantes dans l'ordre :

1. Vérifiez que les paramètres du menu sont conformes aux réglementations sur les poids et mesures en vigueur.
2. Vérifiez que les unités activées sont conformes aux réglementations locales en matière de poids et mesures.
3. Effectuez un étalonnage comme expliqué dans la section Étalonnage.
4. Entrez dans le menu d'étalonnage et réglez l'étalonnage interne, en vous assurant qu'il est conforme aux réglementations locales en matière de poids et mesures.
 - a) Appuyez sur le bouton **Tare/Menu-Cal** et sélectionnez **InCal**.
 - b) Appuyez sur le bouton **Print/Unit** pour passer le paramètre Étalonnage interne sur **On** ou **Off**.
Attention : L'étalonnage interne doit être désactivé lorsque la balance est utilisée pour le commerce au Canada.
 - c) Appuyez sur le bouton **Zero** pour confirmer, puis appuyez sur le bouton **Tare/Menu-Cal** pour quitter le menu.
5. Activez le Mode approuvé dans le menu de configuration de la balance. Pour les modèles dont la taille de la graduation peut être sélectionnée, réglez la valeur souhaitée dans le menu LFT comme expliqué dans la section **Mode approuvé**.
6. Pour les modèles certifiés par Mesures Canada et NTEP avec une taille de graduation sélectionnable, fixez l'étiquette de capacité et de lisibilité appropriée à la balance à l'endroit indiqué ci-dessous.
 - a) Récupérez le jeu de deux étiquettes dans l'emballage.
 - b) Prenez l'étiquette qui correspond à la taille de la graduation définie dans le menu LFT.
 - c) Retirez le couvercle de protection en plastique transparent du terminal, le cas échéant.
 - d) Retirez la pellicule du support adhésif et fixez l'étiquette sur la zone située au-dessus de l'écran.
 - e) Réinstallez le couvercle de protection en plastique transparent, le cas échéant.

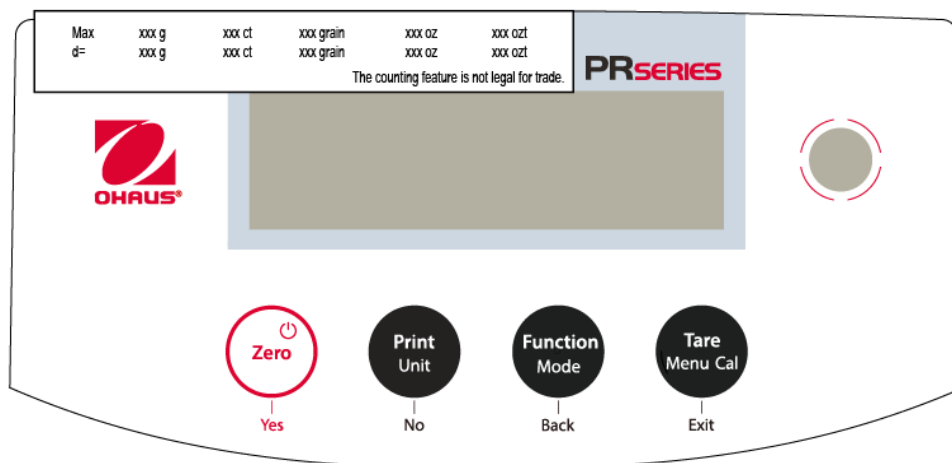

Remarque: Lorsque le mode approuvé est réglé sur marche, le calibrage externe ne fonctionne pas.

6.2 Vérification

Une responsable de mesure et de poids ou un agent de service autorisé doit effectuer la procédure de vérification.

6.3 Scellement

Une fois la balance vérifiée, elle doit être scellée afin d'empêcher un accès non autorisé aux réglages légalement contrôlés. Avant le scellement de l'appareil, s'assurer que le commutateur de sécurité est en position verrouillé et que le réglage de mode approuvé dans le menu de réglage de la balance est réglé sur Marche.

- Si vous utilisez un sceau de papier, placer le sceau sur le commutateur de sécurité et sur le boîtier de bas comme indiqué.
- Si vous utilisez un joint de fil, placer le fil sur le commutateur de sécurité et sur le boîtier de bas comme indiqué.



Figure 6-1. Scellement

7. IMPRESSION

7.1 Connexion, configuration et test de l'imprimante / Interface de l'ordinateur

Utiliser le port RS-232 intégré pour connecter à un ordinateur ou à une imprimante.

Si vous connectez à un ordinateur, utiliser un hyper terminal ou un logiciel similaire comme SPDC comme décrit ci-dessous.

(Retrouver Hyper Terminal sous **Accessoires/Communications** dans Windows XP.)

Connecter à un ordinateur avec un câble de série standard (droit).

Choisir **Nouvelle Connexion**, "connecter en utilisant" COM1 (ou le port COM disponible).

Sélectionner **Baud=9600; Parité=8 Aucun; Stop=1; Salutations=Aucun**. Cliquer sur **OK**.

Choisir Propriétés/Réglages, ensuite le réglage ASCII. Vérifier les cases suivant l'illustration: (**Envoyer les extrémités de ligne...; Caractères de type Echo...; Lignes d'emballage...**)

Utiliser les commandes d'interface RS232 (Section 9.6.1) pour contrôler la balance à partir d'un PC.

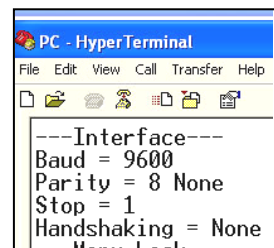

Logiciel SPDC

Le port de série des données de collecte/logiciel SPDC est fourni par Ohaus et pourrait être utilisé sur les systèmes d'exploitation ne disposant pas le logiciel HyperTerminal susmentionné. Le logiciel SPDC pourrait tout d'abord collecter et transférer les données aux fichiers Microsoft (notamment Excel, Word, etc.).

Choisir le type de fichier d'exportation et exporter le chemin du fichier, ensuite appuyer sur Exécuter comme indiqué ci-dessous.

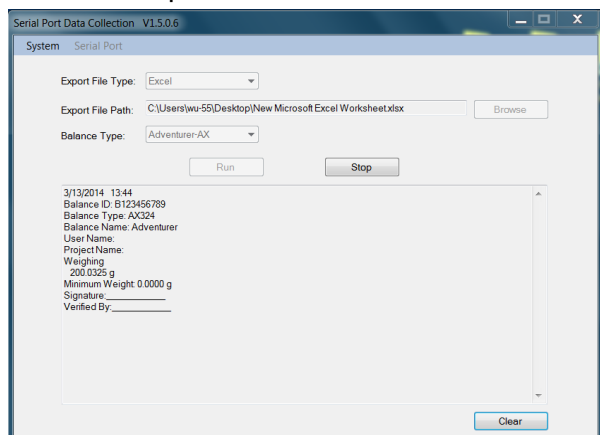

Exigences du système

- PC fonctionnant sous Windows 98®, Windows 98SE®, Windows ME®, Windows 2000®, Windows XP®, Windows 7® or Windows 8® (32-bit).

Remarque: Le tout récent logiciel SDPC supporte les langues anglaise et chinoise et pourrait être téléchargé à partir du site web d'Ohaus. Pour des informations supplémentaires, se référer au *manuel d'instruction de collecte des données SPDC*.

7.2 Format d’affichage

Les données de résultat et les données G/N/T sont l’affichage sous le format suivant.

Champ:	Étiquette ¹	Espace ²	Poids ³	Espace ²	Unité ⁴	Espace	Stabilité ⁵	Espace	G/N ⁶	Espace	Terme Caractères ⁷
Longueur:		1	11	1	5	1	≤ 1	≤ 1	≤ 3	0	≤ 8

Remarque:

1. La longueur du champ d’étiquette n’est pas fixée.
2. Chaque champ est suivi par un espace de délimitation unique (ASCII 32).
3. Le poids du champ est les caractères justifiés 11. Si la valeur est négative, le caractère ‘-’ est situé à la gauche immédiate du chiffre le plus significatif.
4. Le champ d’unité contient l’unité de l’abréviation de mesure atteignant jusqu’au caractère 5, justifié.
5. Le champ de stabilité contient le caractère “?” si la lecture du poids n’est pas stable. Le champ de stabilité et le champ d’espace suivant sont omis si la lecture du poids est stable.
6. Le champ G/N contient l’indication nette ou brute. Pour les poids nets, le champ contient « N ». Pour les poids bruts, le champ contient « B ».
7. Le champ de caractères de fin contient CRLF, quatre CRLF ou la forme d’alimentation (ASCII 12) en fonction du réglage de menu de la ligne d’alimentation.
8. Lorsque réglé uniquement sur numérique actif, uniquement le champ de poids est imprimé, aligné à gauche.

7.3 Exemples imprimés

Les exemples pour chaque application sont affichés avec tous les éléments réglés sur **MARCHE** dans le menu **Imprimer**. Les valeurs par défaut pour les les lignes d’**en-tête** 1-3 sont également affichées.

Poids de base

Comptage de pesage

Pesage en pourcentage

```
Header 1
Header 2
Header 3
07/19/2017 17:56:23
Balance ID: B234567890
Balance Name: PR4202/E
User Name:
Project Name:
Weigh
  0.10 g
Gross:    0.10 g G
Net:      0.10 g N
Tare:     0.00 g T

Signature: _____
Verified By: _____
```

```
Header 1
Header 2
Header 3
07/19/2017 17:57:19
Balance ID: B234567890
Balance Name: PR4202/E
User Name:
Project Name:
Count
Quantity: 4999 PCS
Gross:    49.99 g G
Net:      49.99 g N
Tare:     0.00 g T
APW: 0.010 g
Sample Size: 10 PCS

Signature: _____
Verified By: _____
```

```
Header 1
Header 2
Header 3
07/19/2017 17:57:19
Balance ID: B234567890
Balance Name: PR223/E
User Name:
Project Name:
Percent
Percentage: 10.156 % N
Gross:    23.361 g G
Net:      10.156 g N
Tare:     13.205 g T
Reference weight: 100.000 g

Signature: _____
Verified By: _____
```

Calibrage interne

Calibrage de portée

Calibrage de linéarité

-OHAUS-
07/26/2017 05:16:53
Balance ID:
Balance Name: PR2202
User Name:
Project Name:
---Internal Calibration---
Calibration is done.
Difference weight: 0.00 g

Signature: _____
Verified By: _____

-OHAUS-
07/26/2017 05:16:37
Balance ID:
Balance Name: PR2202
User Name:
Project Name:
---Span Calibration---
Calibration is done.
Reference weight: 2000.00 g
Actual weight: 2000.22 g
Difference weight: 0.22 g
Weight ID: _____

Signature: _____
Verified By: _____

-OHAUS-
07/26/2017 05:16:11
Balance ID:
Balance Name: PR2202
User Name:
Project Name:
---Linear Calibration---
Calibration is done.

Signature: _____
Verified By: _____

8. ENTRETIEN

8.1 Calibrage

Vérifier périodiquement le calibrage en plaçant un poids précis sur la balance et en observant le résultat. Si le calibrage est nécessaire, se référer à la section 5.2 pour les instructions.

8.2 Nettoyage



AVERTISSEMENT: Déconnecter la balance de l'alimentation avant le nettoyage. S'assurer qu'aucun liquide n'entre dans la balance.



Nettoyer la balance à des intervalles réguliers.



Les surfaces du boîtier pourraient être nettoyées avec un tissu sans peluche légèrement mouillé avec de l'eau ou un agent de nettoyage doux.



Les surfaces en verre pourraient être nettoyées avec un nettoyant de verre commercial.

Attention: Évitez d'utiliser les solvants, notamment les produits chimiques durs, les agents de nettoyage abrasifs ou en ammoniaque.

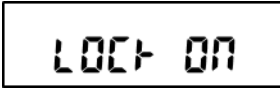
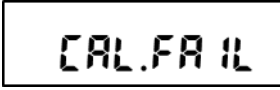
8.3 Dépannage

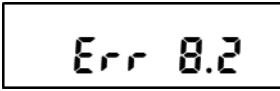
TABLEAU 8-1. DEPANNAGE

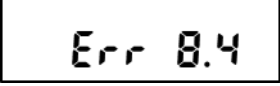
Symptôme / Affichage	Cause possible	Solution
Impossible de modifier les paramètres du menu. 	Le sous-menu est verrouillé.	Déverrouillez le sous-menu dans le menu de verrouillage.
Certains sous-menus sont masqués.	Il s'agit d'un modèle certifié, le blocage de certains sous-menus est obligatoire.	Configurez la balance avant d'activer le paramètre Legal for Trade setting (Approuvé pour usage commercial).
	L'environnement n'est pas stable.	Déplacez la balance dans un endroit approprié et calibrez-la de nouveau
	Des masses d'étalonnage incorrectes sont utilisées.	Utilisez des masses d'étalonnage pour calibrer selon les points d'étalonnage corrects comme indiqué dans le tableau des spécifications du manuel d'instructions.
	Erreur système	Si l'erreur persiste, veuillez contacter les services OHAUS (www.ohaus.com - En savoir plus - Nous contacter)
	Un mauvais plateau de pesée est utilisé lors de la mise sous tension.	Utilisez le plateau de pesée d'origine OHAUS avant la mise sous tension.
	La charge sur le plateau dépasse le réglage du poids initial.	Retirez la charge du plateau avant la mise sous tension.
	Un mauvais plateau de pesée est utilisé lors de la mise sous tension.	Utilisez le plateau de pesée d'origine OHAUS avant la mise sous tension.
	Le plateau n'est pas installé lors de la mise sous tension.	Installez le plateau de pesée avant de le mettre sous tension.

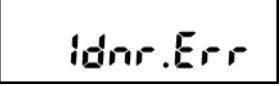
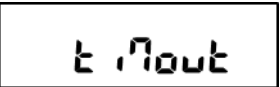
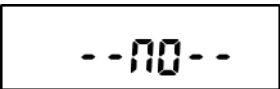
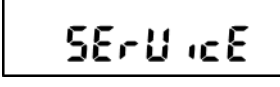
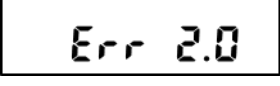
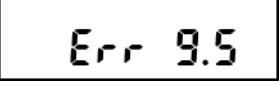
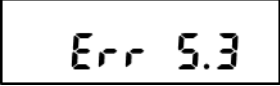
	Le poids sur le plateau est trop lourd.	Réduisez la taille de l'échantillon jusqu'à ce que le poids entre dans la capacité de pesée.
	Le plateau n'est pas correctement installé.	Installez correctement le plateau de pesage
	Le poids unitaire moyen de l'échantillon est trop petit (moins de 0,1 d) en mode Comptage de pièces.	Recalculez la valeur d'APW. Si l'erreur persiste, veuillez utiliser un autre échantillon.
	Le poids de référence sur le plateau est trop petit (moins de 100 d) en mode Pesée en pourcentage.	Placez plus d'échantillons sur le plateau
	Erreur système	Veuillez contacter les services OHAUS (www.ohaus.com - En savoir plus - Nous contacter)
	L'environnement n'est pas stable.	Déplacez la balance dans un endroit approprié
Lors de la pression sur la touche Tare/Zéro 	La valeur est en dehors de la plage du zéro. La plage du zéro dépend de la région.	Étalonnez de nouveau le zéro suivant les indications pour votre région.
	La valeur de tare est une valeur négative.	Appuyez sur Zéro au lieu de Tare
	Erreur système	Veuillez contacter les services OHAUS (www.ohaus.com - En savoir plus - Nous contacter)
  	Erreur système	Débranchez l'alimentation et redémarrez. Si l'erreur persiste, veuillez contacter les services OHAUS (www.ohaus.com - En savoir plus - Nous contacter)

8.4 Renseignement sur le service

Si La section de dépannage ne résout pas votre problème; contacter votre agent de service autorisé Ohaus Veuillez visiter notre site web à l'adresse www.ohaus.com afin de localiser le bureau Ohaus le plus proche.

9. DONNÉES TECHNIQUES

9.1 Spécifications

Conditions ambiantes

- Utilisation intérieure uniquement.
- Altitude: Jusqu'à 2000 m
- Plage de température spécifiée: 10°C à 30°C
- Humidité: humidité relative maximale 80% pour les températures dépassant 30°C, baissant de manière linéaire de 50% à une humidité relative de 40°C
- L'exploitation est garantie à des températures ambiantes entre 5 et 40 °C
- Fluctuations de tension d'alimentation: jusqu'à $\pm 10\%$ de la tension nominale.
- Catégorie d'installation II
- Degré de pollution 2
- Tension d'alimentation: 12V \pm 0.5A

Matériels

- Boîtier de bas: Aluminium moulé, Peint + Plastic (HIPS)
- Boîtier de haut: Plastic (HIPS)
- Plateformes de pesage: Acier inoxydable
- Paravent: Verre, plastic (HIPS)
- Pieds: Plastic (ABS)

Tableau 9-1 SPECIFICATIONS

Modèle InCal		PR124	PR224	PR223	PR423	PR523
Modèle ExCal	PR64/E	PR124/E	PR224/E	PR223/E	PR423/E	PR523/E
Capacité (g)	62	120	220	220	420	520
Lisibilité d (g)	0,0001	0,0001	0,0001	0,001	0,001	0,001
Répétabilité SD, ≤5% de la pleine charge (g)	0.00008	0.00008	0.00008	0.0008	0.0008	0.0008
Répétabilité SD, 5% de la pleine charge à la gamme complète (g)	0.0001	0.0001	0.0001	0.001	0.001	0.001
Déviations de linéarité, typique (g)	± 0.00006	± 0.00006	± 0.00006	±0.0006	±0.0006	±0.0006
Déviations de linéarité (g)	± 0.0002	± 0.0002	± 0.0002	±0.002	±0.002	±0.002
Temps de stabilisation typique (s)	3	3	3	2	2	2
Dérive de sensibilité de la température (PPM/K)	±3	±3	±3	±8	±3	±3
Poids minimum typique USP (USP K=2,U=0,10%)	160 mg	160 mg	160 mg	1,6 g	1,6 g	1,6 g
Poids min optimisé (g) (USP, u=0,10%, k=2) SRP ≤ 0,41d*	82 mg	82 mg	82 mg	0,82 g	0,82 g	0,82 g
Unités	Gramme, Milligramme, Carat, Once, Once Troy, Pennyweight, Grain, Taiwan Tael, Newton, Custom 1			Gramme, Milligramme, Kilogramme, Carat Once, Once Troy, Pennyweight, Grain, Livre, Taiwan Tael, Newton, Custom 1		
Applications	Poids de base; décompte des pièces; pesage de pourcentage					
Taille de plateforme (diamètre)	3,5 pouces / 9 cm	3,5 pouces / 9 cm	3,5 pouces / 9 cm	4,7 pouces / 12 cm	4,7 pouces / 12 cm	4,7 pouces / 12 cm
Points de calibrage de portée (g)	50, 60	50, 100	100, 200	100, 200	200, 400	300, 500
Points de calibrage de linéarité (g)	0, 30, 60	0, 50, 100	0, 100, 200	0, 100, 200	0, 200, 400	0, 250, 500
Plage de tare	A la capacité par soustraction					
Source d'alimentation	Puissance d'entrée 100-240 V ~ 200 mA 50-60Hz 12-18VA Sortie d'alimentation: 12 VDC 0.5A					
Dimensions assemblées (l x D x H) (mm)	201 x 317 x 303 mm 7.9 x 12.5 x 11.9 inch					
Communication	RS232					
Plage de température d'opération	Conditions d'utilisation pour des applications normales en laboratoire: +10°C à 30 °C (opérabilité garantie entre +5°C et 40 °C)					
Plage de température de stockage	Humidité: humidité relative maximale 80 % pour les températures dépassant 30°C, baissant de manière linéaire de 50% à une humidité relative de 40°C					
Conditions de stockage	-10°C à 60°C, humidité 10% à 90%, sans condensation					
Poids net	10 lb / 4,5 kg					
Poids d'expédition	15,4lb / 7 kg					
Dimensions d'expédition (l x D x H) (mm)	507 x 387 x 531					

*SRP se réfère à la déviation standard pour les pesages de processus n (n≥10).

Tableau 9-2 SPECIFICATIONS (Suite)

Modèle InCal	PR1602	PR2202	PR4202		PR4201	PR6201
Modèle ExCal	PR1602/E	PR2202/E	PR4202/E	PR2201/E	PR4201/E	PR6201/E
Capacité (g)	1600	2200	4200	2200	4200	6200
Lisibilité d (g)	0,01	0,01	0,01	0.1	0,1	0,1
Répétabilité SD, ≤5% de la pleine charge (g)	0.008	0.008	0.008	0.08	0.08	0.08
Répétabilité SD, 5% de la pleine charge à la gamme complète (g)	0.01	0.01	0.01	0.1	0.1	0.1
Déviations de linéarité, typique (g)	±0.006	±0.006	±0.006	±0.06	±0.06	±0.06
Déviations de linéarité (g)	±0.02	±0.02	±0.02	±0.2	±0.2	±0.2
Temps de stabilisation typique (s)	1	1	1	1	1	1
Dérive de sensibilité de la température (PPM/K)	±6	±6	±3	±10	±10	±10
Poids minimum typique USB (USP K=2,U=0,10%)	16 g	16 g	16 g	160 g	160 g	160 g
Poids min optimisé (g) (USP, u=0,10%, k=2) SRP ≤ 0,41d*	8,2 g	8,2 g	8,2 g	82 g	82 g	82 g
Unités	Gramme, Kilogramme, Carat, Newton, Pound, Ounce, Ounce Troy, Pennyweight, Grain, Taiwan Tael, Custom 1					
Applications	Poids de base; décompte des pièces; pesage de pourcentage					
Taille de plateforme (diamètre, mm)	7,1 pouces / 18 cm	7,1 pouces / 18 cm	7,1 pouces / 18 cm	7.1 in / 18 cm	7,1 pouces / 18 cm	7,1 pouces / 18 cm
Points de calibrage de portée (g)	1000, 1500, 1600	1000, 2000	2000, 4000	1000, 2000	2000, 4000	5000, 6000
Points de calibrage de linéarité (g)	0, 800, 1600	0, 1000, 2000	0, 2000, 4000	0, 1000, 2000	0, 2000, 4000	0, 3000, 6000
Plage de tare	A la capacité par soustraction					
Source d'alimentation	Puissance d'entrée 100-240 V ~ 200 mA 50-60Hz 12-18VA Sortie d'alimentation: 12 VDC 0.5A					
Dimensions assemblées (l x D x H) (mm)	201 x 317 x 93 mm 7.9 x 12.5 x 3.7 inch					
Communication	RS232					
Plage de température d'opération	Conditions d'utilisation pour des applications normales en laboratoire: +10°C à 30 °C (opérabilité garantie entre +5°C et 40 °C)					
Plage de température de stockage	Humidité: humidité relative maximale 80 % pour les températures dépassant 30°C, baissant de manière linéaire de 50% à une humidité relative de 40°C					
Conditions de stockage	-10°C à 60°C, humidité 10% à 90%, sans condensation					
Poids net	7,7 lb / 3,5 kg					
Poids d'expédition	11 lb / 5 kg					
Dimensions d'expédition (l x D x H) (mm)	550 x 385 x 291					

*SRP se réfère à la déviation standard pour les pesages de processus n (n≥10).

Table 9-3 SPECIFICATIONS (continued)

Modèle InCal		PR523N
Modèle ExCal	PR323N/E	PR523N/E
Capacité (g)	320	520
Lisibilité d (g)	0.001 ou 0.01	0.001 ou 0.01
Intervalle de vérification e (g)	0.01	0.01
Classe	II	II
Répétabilité SD, ≤5% de la pleine charge (g)	0.00008	0.00008
Répétabilité SD, 5% de la pleine charge à la gamme complète (g)	0.0001	0.0001
Déviation de linéarité, typique (g)	± 0.00006	± 0.00006
Déviation de linéarité (g)	± 0.0002	± 0.0002
Charge excentrique	Ne dépassant pas l'erreur maximale tolérée pour le tiers de la capacité totale de la balance	
Temps de stabilisation typique (s)	2	2
Dérive de sensibilité de la température (PPM/K)	±3	±3
Poids minimum typique USB (USP K=2,U=0,10%)	1.6g	1.6g
Poids min optimisé (g) (USP, u=0,10%, k=2) SRP ≤ 0,41d*	0.82g	0.82g
Unités	Gramme, Milligramme, Carat, Ounce, Ounce Troy, Grain	
Applications	Poids de base; décompte des pièces; pesage de pourcentage	
Taille de plateforme (diamètre)	4.7 in / 12 cm	4.7 in / 12 cm
Points de calibrage de portée (g)	200,300	300, 500
Points de calibrage de linéarité (g)	0, 150, 300	0, 250, 500
Plage de tare	A la capacité par soustraction	
Source d'alimentation	Puissance d'entrée 100-240 V ~ 200 mA 50-60Hz 12-18VA Sortie d'alimentation: 12 VDC 0.5A	
Dimensions assemblées (l x D x H) (mm)	201 x 317 x 303 mm 7.9 x 12.5 x 11.9 inch	
Communication	RS232	
Plage de température d'opération	Conditions d'utilisation pour des applications normales en laboratoire: +10°C à 30 °C (opérabilité garantie entre +5°C et 40 °C)	
Plage de température de stockage	Humidité: humidité relative maximale 80 % pour les températures dépassant 30°C, baissant de manière linéaire de 50% à une humidité relative de 40°C	
Conditions de stockage	-10°C à 60°C, humidité 10% à 90%, sans condensation	
Poids net	10 lb / 4.5 kg	10 lb / 4.5 kg
Poids d'expédition	15.4lb / 7 kg	15.4lb / 7 kg
Dimensions d'expédition (l x D x H) (mm)	507 x 387 x 531mm 20 x 15 x 21 inch	

*SRP se réfère à la déviation standard pour les pesages de processus n (n≥10).

Table 9-4 SPECIFICATIONS (continued)

Modèle ExCal	PR322N/E	PR522N/E	PR822N/E	PR2202N/E	PR4202N/E	PR5202N/E
Capacité (g)	320	520	820	2200	4200	5200
Lisibilité d (g)	0.01	0.01	0.1	0.01 ou 0.1	0.01 ou 0.1	0.01 ou 0.1
Intervalle de vérification e (g)	0.01	0.01	0.1	0.1	0.1	0.1
Classe	II	II	III	II	II	II
Répétabilité SD, ≤5% de la pleine charge (g)	0.008	0.008	0.008	0.008	0.008	0.008
Répétabilité SD, 5% de la pleine charge à la gamme complète (g)	0.01	0.01	0.01	0.01	0.01	0.01
Déviations de linéarité, typique (g)	±0.006	±0.006	±0.006	±0.006	±0.006	±0.006
Déviations de linéarité (g)	±0.02	±0.02	±0.02	±0.02	±0.02	±0.02
Charge excentrique	Ne dépassant pas l'erreur maximale tolérée pour le tiers de la capacité totale de la balance					
Temps de stabilisation typique (s)	1	1	1	1	1	1
Dérive de sensibilité de la température (PPM/K)	±3	±3	±6	±6	±3	±3
Poids minimum typique USB (USP K=2,U=0,10%)	16g	16g	16g	16g	16g	16g
Poids min optimisé (g) (USP, u=0,10%, k=2) SRP ≤ 0,41d*	8.2g	8.2g	8.2g	8.2g	8.2g	8.2g
Unités	Gramme, Kilogramme, Carat, Pound, Ounce, Ounce Troy, Grain					
Applications	Poids de base; décompte des pièces; pesage de pourcentage					
Taille de plateforme (diamètre)	4.7 in / 12 cm			7.1 in / 18 cm		
Points de calibrage de portée (g)	150, 300	250,500	400,800	1000, 2000	2000, 4000	2500, 5000
Points de calibrage de linéarité (g)	200, 300	300, 500	500, 800	0, 1000, 2000	0, 2000, 4000	3000, 5000
Plage de tare	A la capacité par soustraction					
Source d'alimentation	Puissance d'entrée 100-240 V ~ 200 mA 50-60Hz 12-18VA Sortie d'alimentation: 12 VDC 0.5A					
Dimensions assemblées (l x D x H) (mm)	201 x 317 x 303 mm 7.9 x 12.5 x 11.9 inch			201 x 317 x 93 mm 7.9 x 12.5 x 3.7 inch		
Communication	RS232					
Plage de température d'opération	Conditions d'utilisation pour des applications normales en laboratoire: +10°C à 30 °C (opérabilité garantie entre +5°C et 40 °C)					
Plage de température de stockage	Humidité: humidité relative maximale 80 % pour les températures dépassant 30°C, baissant de manière linéaire de 50% à une humidité relative de 40°C					
Conditions de stockage	-10°C à 60°C, humidité 10% à 90%, sans condensation					
Poids net	10 lb / 4.5 kg			7.7 lb / 3.5 kg		
Poids d'expédition	15.4 lb / 7 kg			11 lb / 5 kg		
Dimensions d'expédition (l x D x H) (mm)	507 x 387 x 531 mm 20 x 15 x 21 inch			550 x 385 x 291 mm 22 x 15 x 12 inch		

*SRP se réfère à la déviation standard pour les pesages de processus n (n≥10).

Table 9-5 SPECIFICATIONS (continued)

Modèle ExCal	PR2201N/E	PR4201N/E	PR5201N/E	PR6201N/E
Capacité (g)	2200	4200	5200	6200
Lisibilité d (g)	0.1	0.1	0.1	0.1 ou 1
Intervalle de vérification e (g)	0.1	0.1	0.1	1
Classe	II	II	II	III
Répétabilité SD, ≤5% de la pleine charge (g)	0.08	0.08	0.08	0.08
Répétabilité SD, 5% de la pleine charge à la gamme complète (g)	0.1	0.1	0.1	0.1
Déviations de linéarité, typique (g)	±0.06	±0.06	±0.06	±0.06
Déviations de linéarité (g)	±0.2	±0.2	±0.2	±0.2
Charge excentrique	Ne dépassant pas l'erreur maximale tolérée pour le tiers de la capacité totale de la balance			
Temps de stabilisation typique (s)	1	1	1	1
Dérive de sensibilité de la température (PPM/K)	±10	±10	±3	±10
Poids minimum typique USB (USP K=2,U=0,10%)	160g	160g	160g	160g
Poids min optimisé (g) (USP, u=0,10%, k=2) SRP ≤ 0,41d*	82g	82g	82g	82g
Unités	Gramme, Kilogramme, Carat, Pound, Ounce, Ounce Troy, Grain			
Applications	Poids de base; décompte des pièces; pesage de pourcentage			
Taille de plateforme (diamètre)	7.1 in / 18 cm			
Points de calibrage de portée (g)	1000, 2000	2000, 4000	3000, 5000	5000, 6000
Points de calibrage de linéarité (g)	0, 1000, 2000	0, 2000, 4000	0, 2500, 5000	0, 3000, 6000
Plage de tare	A la capacité par soustraction			
Source d'alimentation	Puissance d'entrée 100-240 V ~ 200 mA 50-60Hz 12-18VA Sortie d'alimentation: 12 VDC 0.5A			
Dimensions assemblées (l x D x H) (mm)	201 x 317 x 93 mm 7.9 x 12.5 x 3.7 inch			
Communication	RS232			
Plage de température d'opération	Conditions d'utilisation pour des applications normales en laboratoire: +10°C à 30 °C (opérabilité garantie entre +5°C et 40 °C)			
Plage de température de stockage	Humidité: humidité relative maximale 80 % pour les températures dépassant 30°C, baissant de manière linéaire de 50% à une humidité relative de 40°C			
Conditions de stockage	-10°C à 60°C, humidité 10% à 90%, sans condensation			
Poids net	7.7 lb / 3.5 kg			
Poids d'expédition	11 lb / 5 kg			
Dimensions d'expédition (l x D x H) (mm)	550 x 385 x 291 mm 22 x 15 x 12 inch			

*SRP se réfère à la déviation standard pour les pesages de processus n (n≥10).

Table 9-6 SPECIFICATIONS (continued)

Modèle InCal approuvé	PR124M	PR224M	PR223M	PR323M	PR423M	PR523M
Capacité (g)	120	220	220	320	420	520
Lisibilité d (g)	0.0001	0.0001	0.001	0.001	0.001	0.001
Intervalle de vérification e (g)	0.001	0.001	0.01	0.01	0.01	0.01
Classe:	I	I	II	II	II	II
Répétabilité SD, ≤5% de la pleine charge (g)	0.00008	0.00008	0.0008	0.0008	0.0008	0.0008
Répétabilité SD, 5% de la pleine charge à la gamme complète (g)	0.0001	0.0001	0.001	0.001	0.001	0.001
Déviations de linéarité, typique (g)	± 0.00006	± 0.00006	±0.0006	±0.0006	±0.0006	±0.0006
Déviations de linéarité (g)	± 0.0002	± 0.0002	±0.002	±0.002	±0.002	±0.002
Temps de stabilisation typique (s)	3	3	2	2	2	2
Dérive de sensibilité de la température (PPM/K)	±3	±3	±3	±3	±3	±3
Poids minimum typique USP (USP K=2,U=0,10%)	160 mg	160 mg	1.6 g	1.6 g	1.6 g	1.6 g
Poids min optimisé (g) (USP, u=0,10%, k=2) SRP ≤ 0,41d*	82 mg	82 mg	0.82 g	0.82 g	0.82 g	0.82 g
Unités	g, mg, ct					
Applications	Poids de base, décompte des pièces, pourcentage de pesage, pesage dynamique, détermination de densité					
Taille de plateforme (diamètre, mm)	90	90	120	120	120	120
Points de calibrage de portée (g)	50, 100	100, 200	100, 200	200, 300	200, 400	300, 500
Points de calibrage de linéarité (g)	0, 50, 100	0, 100, 200	0, 100, 200	0, 150, 300	0, 200, 400	0, 250, 500
Plage de tare	A la capacité par soustraction					
Source d'alimentation	Puissance d'entrée 12V DC 1A à partir de la source d'alimentation externe AC/DC Sortie d'alimentation: 12 VDC 0.5A					
Dimensions assemblées (l x D x H) (mm)	209 x 321 x 309					
Communication	RS232					
Plage de température d'opération	Conditions d'utilisation pour des applications normales en laboratoire: +10°C à 30 °C (opérabilité garantie entre +5°C et 40 °C)					
Plage de température de stockage	Humidité: humidité relative maximale 80% pour les températures dépassant 30°C, baissant de manière linéaire de 50% à une humidité relative de 40°C					
Conditions de stockage	-10°C à 60°C, humidité 10% à 90%, sans condensation					
Poids net	10 lb / 4.5 kg					
Poids d'expédition	15.4 lb / 7 kg					
Dimensions d'expédition (l x D x H) (mm)	507 x 387 x 531					

*SRP se réfère à la déviation standard pour les pesages de processus n (n≥10).

Table 9-7 SPECIFICATIONS (continued)

Modèle InCal approuvé	PR1602M	PR2202M	PR4202M	PR5202M	PR4201M	PR6201M
Capacité (g)	1600	2200	4200	5200	4200	6200
Lisibilité d (g)	0.01	0.01	0.01	0.01	0.1	0.1
Intervalle de vérification e (g)	0.1	0.1	0.1	0.1	0.1	1
Classe:	II	II	II	II	II	II
Répétabilité SD, ≤5% de la pleine charge (g)	0.008	0.008	0.008	0.008	0.08	0.08
Répétabilité SD, 5% de la pleine charge à la gamme complète (g)	0.01	0.01	0.01	0.01	0.1	0.1
Déviations de linéarité, typique (g)	±0.006	±0.006	±0.006	±0.006	±0.06	±0.06
Déviations de linéarité (g)	±0.02	±0.02	±0.02	±0.02	±0.2	±0.2
Temps de stabilisation typique (s)	1	1	1	1	1	1
Dérive de sensibilité de la température (PPM/K)	±3	±3	±3	±3	±10	±10
Poids minimum typique USP (USP K=2,U=0,10%)	16 g	16 g	16 g	16 g	160 g	160 g
Poids min optimisé (g) (USP, u=0,10%, k=2) SRP ≤ 0,41d*	8.2 g	8.2 g	8.2 g	8.2 g	82 g	82 g
Unités	g, kg, ct					
Applications	Poids de base, décompte des pièces, pourcentage de pesage, pesage dynamique, détermination de densité					
Taille de plateforme (diamètre, mm)	180	180	180	180	180	180
Points de calibrage de portée (g)	1000, 1500, 1600	1000, 2000	2000, 4000	3000, 5000	2000, 4000	5000, 6000
Points de calibrage de linéarité (g)	0, 800, 1600	0, 1000, 2000	0, 2000, 4000	0, 2500, 5000	0, 2000, 4000	0, 3000, 6000
Plage de tare	A la capacité par soustraction					
Source d'alimentation	Puissance d'entrée 12V DC 1A à partir de la source d'alimentation externe AC/DC Sortie d'alimentation: 12 VDC 0.5A					
Dimensions assemblées (l x D x H) (mm)	209 x 321 x 98					
Communication	RS232					
Plage de température d'opération	Conditions d'utilisation pour des applications normales en laboratoire: +10°C à 30 °C (opérabilité garantie entre +5°C et 40 °C)					
Plage de température de stockage	Humidité: humidité relative maximale 80% pour les températures dépassant 30°C, baissant de manière linéaire de 50% à une humidité relative de 40°C					
Conditions de stockage	-10°C à 60°C, humidité 10% à 90%, sans condensation					
Poids net	7.7 lb / 3.5 kg					
Poids d'expédition	11 lb / 5 kg					
Dimensions d'expédition (l x D x H) (mm)	550 x 385 x 291					

*SRP se réfère à la déviation standard pour les pesages de processus n (n≥10).

9.2 Schémas et dimensions

Dimensions de l'assemblage entier

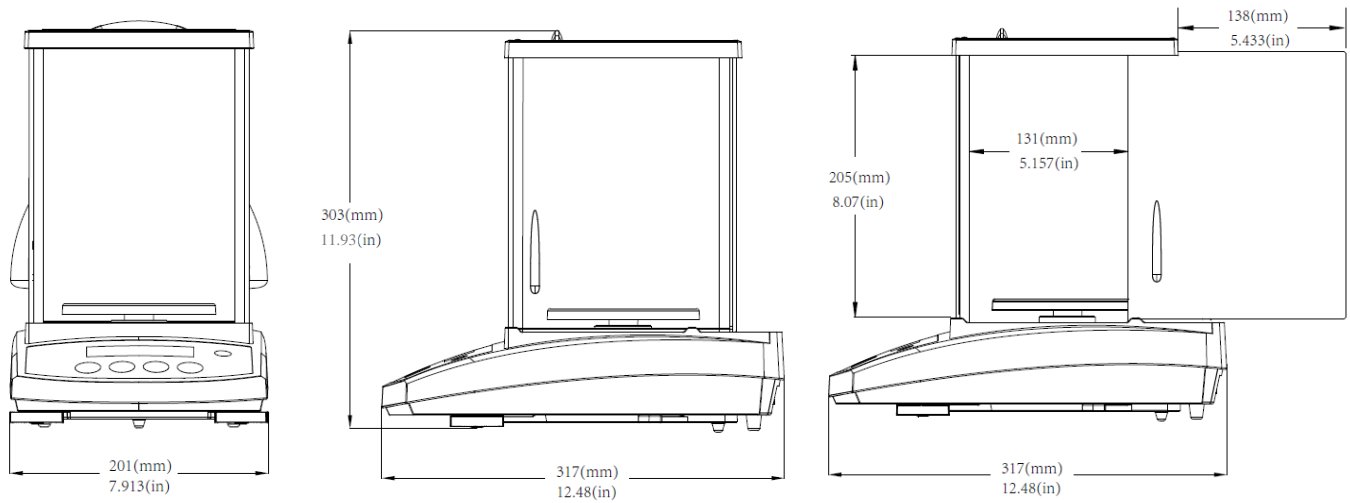

Figure 9-1 0,001 g / 0,0001 g modèle

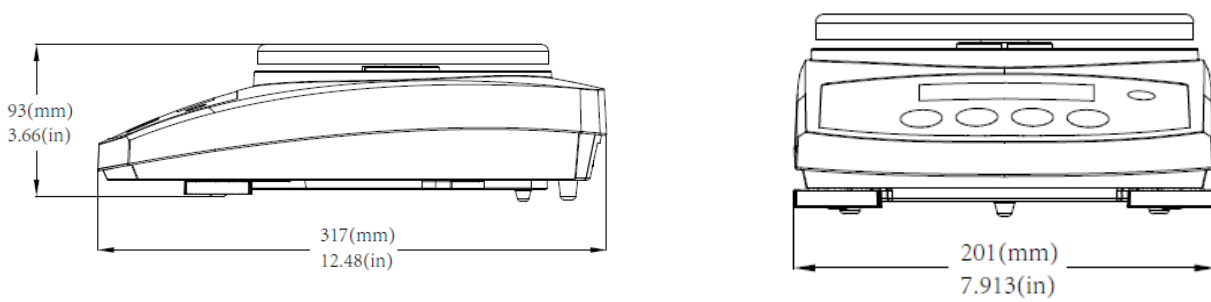

Figure 9-2 0,1 g / 0,01 g modèle

9.3 Accessoires

DESCRIPTION	NUMÉRO DE PIÈCE
Affichage auxiliaire AD7-RS	30472064
Appareil de sécurité	80850043
Câble RS232 (25 broches)	80500524
Câble RS232 (9 broches)	80500525
Couvercle de poussière	30093334
Couvercle d'utilisation	30372547
Imprimante SF40A	30064202 (EU); 30064203 (AM)
Adaptateur d'alimentation pour balance	46001724

9.4 Communication

9.4.1 Commandes d'interface

Les commandes listées dans le tableau suivant seront reconnues par la balance.

Commande	Fonction
IP	Impression immédiate du poids affiché (stable ou instable).
P	Impression du poids affiché (stable ou instable).
CP	Impression continue
SP	Imprimer en cas de stabilité
SLP	Régler l'impression auto à la stabilité, ne pas imprimer le poids de mise à zéro affiché.
SLZP	Régler l'impression auto en cas de stabilité, autoriser l'impression à zéro quelque soit le cas.
xP	Règle l'impression auto à l'intervalle d'impression, x= intervalle d'impression (1-3600 sec), 0p désactive l'intervalle d'impression
0P	0P désactive l'intervalle d'impression, l'impression continue ou l'impression en cas de stabilité
H	Entre les lignes d'en-tête d'impression, le format est: H x « en-tête ». Avec x = numéro de ligne de 1 à 3, "en-tête" pouvant atteindre jusqu'à 24 caractères alphanumériques. Si la série est dans la commande, « Hx » lira l'en-tête x stockée.
Z	Identique à la touche zéro.
T	Identique à la touche tare.
xT***	Établir une valeur de tare pré-réglée dans l'unité affichée. X = valeur tare pré-réglée. L'envoi de 0T efface tare (si autorisé).
PT	Le poids de tare d'impression enregistré dans la mémoire.
PM	Imprime le mode d'application actuel (mode de pesage).
xM	Règle le mode d'application actuel à x. x dépend des applications. 1 – Poids 2 – Décompte 3 – Pourcentage
M	Défiler au mode suivant activé.
MARCHE	Active la veille
ARRET	Entre en veille.
C	Démarre le calibrage de portée
IC	Démarre le calibrage interne
AC	Annule le calibrage.
PSN	Imprime le numéro de série
PV	Version d'impression: imprimer le nom, la révision du logiciel et LFT activé (si LFT est réglé sur Marche).
x#	Régler le décompte APW (x) en grammes. (Doit avoir APW enregistré)
P#	Imprime l'application de décompte APW
x%	Règle le poids de référence du pourcentage d'application (x) en grammes. (Doit avoir un poids de référence stocké).
P%	Imprime le poids de référence du pourcentage d'application.
P HEURE	Imprime l'heure actuelle

Commande	Fonction
PDATE	Imprime la date actuelle
X HEURE	Régler l'heure x format: hh:mm:ss
xDATE	Régler la date x format: mm/jj/aaaa
xS	0 = imprimer les données instables, 1 = imprimer stable uniquement
xRL	Activer ou désactiver la réponse OK aux commandes de non impression: x=0 pour désactiver, x=1 pour activer.
xT	Pré-tare du poids du récipient (x) en grammes.

9.4.2 RS232 (DB9) Connexions de broche





Diagramme	Type	Description
	Type d'interface	Interface de tension conforme à EIA RS-232C/DIN 66020 (CCITT V24/V.28)
	Longueur max du câble	15 m
	Niveau de signal	Sortie: +5 V ... +15 V (RL = 3 – 7kΩ) -5 V ... -15 V (RL = 3 - 7 kΩ) Entrée: +3 V ... +25 V -3 V ... -25 V
	Connecteur	Sous-D, 9-pôle, femelle
	Mode d'opération	Duplex entier
	Mode de transmission	Bit-série, asynchrone
	Code de transmission	ASCII
	Taux de bauds	1200, 2400, 4800, 9600, 19200, 38400 (firmware sélectionnable)
	Bits/parité	7-bit/pair, 7-bit/impair, 7-bit/aucun, 8-bit/aucun (firmware sélectionnable)
	Stop bits	Stop bit 1, 2
	Salutations	Aucun, XON/XOFF, RTS/CTS (sélectionnable)
	Fin de ligne	Non sélectionnable

10. MISE À JOUR DU LOGICIEL

Ohaus met régulièrement à jour le logiciel de sa balance. Pour obtenir la version la plus récente, veuillez contacter un vendeur Ohaus autorisé ou Ohaus Corporation.

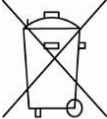
11. CONFORMITE

La conformité aux normes et règlement suivants est indiquée par la marque correspondante sur le produit.

Marque	Norme
	Ce produit est conforme avec les directives UE 2014/30/UE (EMC), 2014/35/UE (LVD) and 2014/31/UE (NAWI). La déclaration de conformité est disponible à l'adresse www.ohaus.com/ce
 	Ce produit est conforme avec la directive 2012/19/UE (WEEE). Veuillez éliminer ce produit conformément aux règlements locaux dans le point de collecte spécifié pour les équipements électriques et électroniques. Pour les instructions de mise au rebut en Europe, veuillez se référer à www.ohaus.com/weee .
	Ce produit est conforme aux normes légales applicables de la Restriction of the Use of Certain Hazardous Substances in Electrical and Electronic Equipment Regulations 2012, UK Electromagnetic Compatibility Regulations 2016, Electrical Equipment (Safety) Regulations 2016 et Non-Automatic Weighing Instruments Regulations 2016. Royaume-Uni La déclaration de conformité est disponible en ligne sur www.ohaus.com/uk-declarations .
	EN 61326-1
	CAN/CSA-C22.2 No. 61010-1 UL Std. No. 61010-1

Note importante pour PX/PXP/PJX/PR...-M instruments de mesure vérifiés dans l'UE et Royaume-Uni.

Lorsque l'instrument est utilisé dans le commerce ou une application régi par la loi, il doit être mis en place, vérifié et scellé conformément à la réglementation poids et mesures. Il incombe à l'acheteur de veiller à ce que toutes les conditions légales soient remplies.

Les instruments de pesage vérifiés sur le lieu de fabrication portent la mention métrologique supplémentaire suivante sur la plaque signalétique.

  1259

  0126

Les instruments de pesage à vérifier en deux étapes ne portent pas de marquage métrologique supplémentaire sur la plaque signalétique. La deuxième étape de l'évaluation de la conformité doit être effectuée par les poids applicables et les autorités de mesures.

Si les réglementations nationales limitent la durée de validité de la vérification, l'utilisateur de l'instrument de pesage doit respecter strictement la période de re-vérification et informer l'autorité des poids et mesures.

Comme les exigences de vérification varient selon les juridictions, l'acheteur doit communiquer avec le bureau des poids et mesures locales si elles ne connaissent pas les exigences.

Déclaration de Conformité Canada ISED :

Cet appareil numérique de classe A est conforme à la norme NMB-003 au Canada.

Enregistrement ISO 9001

Le système de gestion régissant la production de ce produit est certifié ISO 9001.

GARANTIE LIMITÉE

Les produits Ohaus sont garantis contre les défaillances dans les matériels et la fabrication à partir de la date de livraison jusqu'à la couverture entière de la période de garantie. Pendant la période de garantie, Ohaus réparera gratuitement, selon son appréciation ou remplacera tous les composants défectueux, à condition que le produit soit retourné à Ohaus et le fret prépayé.

La présente garantie devient nulle si le produit est endommagé par accident ou par mauvaise utilisation, est exposé aux matériels radioactifs ou corrosifs, comporte des corps étrangers ou suite à une modification ou une réparation par des personnes non autorisées. Outre le renvoi de la carte d'enregistrement de garantie, la période de garantie commence à la date d'expédition au revendeur autorisé. Aucune autre garantie expresse ou implicite n'est offerte par Ohaus Corporation. Ohaus Corporation décline sa responsabilité pour des dommages consécutifs.

Etant donné que la législation de garantie varie selon les états et les pays, veuillez contacter Ohaus ou votre distributeur local Ohaus pour des informations supplémentaires.

Inhaltsverzeichnis

1. EINLEITUNG	DE-3
1.1 Beschreibung	DE-3
1.2 Eigenschaften	DE-3
1.3 Definition von Signalwarnungen und Symbolen	DE-3
1.4 Sicherheitsmaßnahmen	DE-3
2. INSTALLATION.....	DE-4
2.1 Auspacken	DE-4
2.2 Standort auswählen	DE-4
2.3 Nivellierung	DE-4
2.4 Stromanschluss und Akklimatisierung der Waage	DE-4
2.5 Schnittstellenanschluss.....	DE-5
2.6 Erstkalibrierung	DE-5
3. BETRIEB	DE-6
3.1 Überblick über das Display und den Home-Bildschirm	DE-6
3.2 Hauptfunktionen und Hauptmenü	DE-7
3.3 Überblick über Teile und Funktionen - Windschutzmodus	DE-7
3.4 Überblick über Teile und Funktionen - Modelle ohne Windschutzschild	DE-7
4. ANWENDUNGEN	DE-8
4.1 Wägung	DE-8
4.2 Stückzählung	DE-8
4.3 Prozent Wägung	DE-10
4.4 Zusatzfunktionen.....	DE-13
5. MENÜEINSTELLUNGEN	DE-14
5.1 Menünavigation.....	DE-14
5.1.1 Einstellungen ändern	DE-14
5.2 Kalibrierung.....	DE-15
5.2.1 Kalibrierungsuntermenü (InCal-Modelle)	DE-15
5.2.2 Interne Kalibrierung (gilt nicht für ExCal-Modelle)	DE-15
5.2.3 Cal Anpassung (gilt nicht für ExCal-Modelle)	DE-15
5.2.4 Spannenkalibrierung	DE-16
5.2.5 Linearität Kalibrierung	DE-17
5.3 Waageneinstellung	DE-18
5.3.1 Filterebene	DE-18
5.3.2 AZT (Automatische Nullpunktverfolgung)	DE-18
5.3.3 Auto Tara	DE-18
5.3.4 Abstufungen	DE-19
5.3.5 Datumsformat	DE-19
5.3.6 Datumseinstellung	DE-19
5.3.7 Zeitformat.....	DE-19
5.3.8 Zeiteinstellung	DE-20
5.3.9 Helligkeit.....	DE-20
5.3.10 Auto Dim	DE-20
5.3.11 Genehmigt-Modus	DE-20
5.4 Wiegeeinheiten	DE-21
5.5 RS232-Schnittstellenkonfiguration.....	DE-22
5.5.1 Baudrate.....	DE-22
5.5.2 Übertragung	DE-22
5.5.3 Handschlag	DE-23
5.6 Druckeinstellungen	DE-23
5.6.1 Nur stabil.....	DE-23
5.6.2 Nur numerisch.....	DE-23
5.6.3 Einzelne Kopfzeile	DE-23
5.6.4 Auto Druck.....	DE-23
5.6.5 Kopfzeile.....	DE-23
5.6.6 Datum und Uhrzeit.....	DE-23
5.6.7 Waage-ID	DE-23
5.6.8 Waage-Name	DE-23

5.6.9	Benutzername.....	DE-23
5.6.10	Name des Projekts.....	DE-23
5.6.11	Name der Anwendung	DE-23
5.6.12	Ergebnis.....	DE-23
5.6.13	Brutto	DE-23
5.6.14	Netto	DE-23
5.6.15	Tare.....	DE-23
5.6.16	Zeilenvorschub	DE-23
5.7	GLP.....	DE-26
5.7.1	Kopfzeile	DE-26
5.7.2	Waage-Name	DE-26
5.7.3	Benutzername	DE-26
5.7.4	Name des Projekts	DE-26
5.8	Zurücksetzung auf Werkseinstellungen.....	DE-27
5.9	Sperrung	DE-27
6.	EICHPFLICHTIGE ANWENDUNG (LEGAL FOR TRADE, LFT)	DE-28
6.1	Einstellungen	DE-28
6.2	Überprüfung	DE-29
6.3	Versiegelung	DE-29
7.	DRUCK.....	DE-30
7.1	Anschluss, Konfiguration und Testen der Drucker- / Computerschnittstelle	DE-30
7.2	Ausgabeformat.....	DE-31
7.3	Ausdruckbeispiele	DE-31
8.	WARTUNG	DE-33
8.1	Kalibrierung.....	DE-33
8.2	Reinigung	DE-33
8.3	Fehlerbehebung.....	DE-33
8.4	Service-Informationen.....	DE-34
9.	TECHNISCHE DATEN	DE-35
9.1	Spezifikationen.....	DE-35
9.2	Zeichnungen und Dimensionen	DE-43
9.3	Zubehörteile	DE-44
9.4	Kommunikation	DE-44
9.4.1	Schnittstellenbefehle.....	DE-44
9.4.2	RS232 (DB9) Stiftverbindungen.....	DE-45
10.	SOFTWARE UPDATES	DE-45
11.	EINHALTUNG	DE-46

1. EINLEITUNG

1.1 Beschreibung

Die PR-Waage ist eine Präzisionswaage, die Ihnen bei richtiger Pflege jahrelang Dienste erweisen wird. PR-Waagen sind in Kapazitäten von 62 Gramm bis 6200 Gramm erhältlich.

1.2 Eigenschaften

Bedienelemente: hintergrundbeleuchtetes Display mit 3 Wägeanwendungen und vielen Funktionen.



1.3 Definition von Signalwarnungen und Symbolen

Sicherheitshinweise sind mit Signalwörtern und Warnsymbolen gekennzeichnet. Diese zeigen Sicherheitsprobleme und Warnungen an. Das Ignorieren der Sicherheitshinweise kann zu Verletzungen an Personen, Schäden am Gerät, Fehlfunktionen und falschen Ergebnissen führen.

WARNUNG Für eine gefährliche Situation mit mittlerem Risiko, die möglicherweise zu Verletzungen oder zum Tod führt, wenn sie nicht vermieden wird.

VORSICHT Für eine gefährliche Situation mit geringem Risiko, die zu Schäden am Gerät oder am Eigentum oder zu Datenverlust oder Verletzungen führt, wenn sie nicht vermieden wird.

Achtung Für wichtige Informationen über das Produkt

Hinweis Für nützliche Informationen über das Produkt

Warnsymbole



Allgemeines Risiko



Gefahr eines Stromschlags



Wechselstrom



Gleichstrom

1.4 Sicherheitsmaßnahmen



VORSICHT: Lesen Sie alle Sicherheitswarnungen durch, bevor Sie das Gerät installieren, anschließen oder warten. Die Nichtbeachtung dieser Warnungen kann zu Personen- und/oder Sachschäden führen. Bewahren Sie alle Anweisungen zur zukünftigen Referenz auf.

- Stellen Sie sicher, dass der Bereich des Eingangsspannungsbereich und der Steckertyp des Wechselstromadapters mit der lokalen Hauptwechselstromversorgung kompatibel sind.
- Stellen Sie sicher, dass das Netzkabel kein potenzielles Hindernis oder eine Stolpergefahr darstellt.
- Positionieren Sie die Waage so, dass Sie den Stromanschluss leicht erreichen.
- Die Waage ist nur für den Innengebrauch vorgesehen. Betreiben Sie das Gerät nicht in gefährlichen oder instabilen Umgebungen.
- Betreiben Sie das Gerät nur unter den in dieser Anleitung angegebenen Umgebungsbedingungen.
- Lassen Sie keine Lasten auf die Schale fallen.
- Verwenden Sie die Waage nur an trockenen Standorten.
- Trennen Sie das Gerät von der Stromversorgung, wenn Sie es reinigen.
- Verwenden Sie nur zugelassenes Zubehör und Peripheriegeräte.
- Der Service sollte nur von autorisiertem Personal durchgeführt werden.

2. INSTALLATION

2.1 Auspacken

Nehmen Sie vorsichtig Ihre PR-Waage und alle Komponenten aus der Verpackung. Die enthaltenen Komponenten variieren je nach Waagemodell. Bewahren Sie die Verpackung auf, um eine sichere Lagerung und einen sicheren Transport zu gewährleisten. Bitte lesen Sie das Handbuch vollständig durch, bevor Sie die PR-Waage installieren und verwenden, um einen fehlerhaften Betrieb zu vermeiden.

Enthaltene Komponenten:

- Waage
- Netzteil + Anschlussstecker
- Edelstahlschale
- Schalenstütze (nur für 0,1 g / 0,01 g Modell)
- Garantiekarte

2.2 Standort auswählen

Vermeiden Sie Wärmequellen, schnelle Temperaturänderungen, Luftströmungen oder übermäßige Vibrationen. Sorgen Sie für genügend Platz.

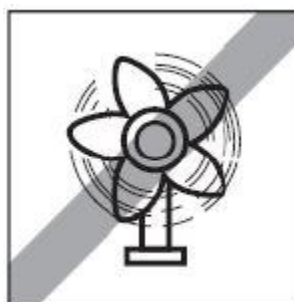
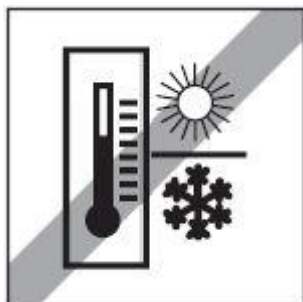
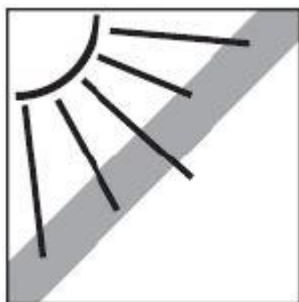

2.3 Nivellierung

Stellen Sie sicher, dass die Waage vor der Verwendung oder nach dem Ändern der Position nivelliert ist.

Die PR-Waage verfügt über eine Nivellierlibelle neben dem Display.

Um die Waage zu nivellieren, passen Sie die 2 Nivellierfüße an, bis die Blase im Kreis zentriert ist.

Siehe bitte rechte Abbildung zur Nivellierung.

2.4 Stromanschluss und Akklimationisierung der Waage

Verbinden Sie den Gleichstromausgangsstecker mit der Buchse auf der Rückseite der Waage. Schließen Sie dann den Wechselstromadapterstecker an eine geeignete Steckdose an.

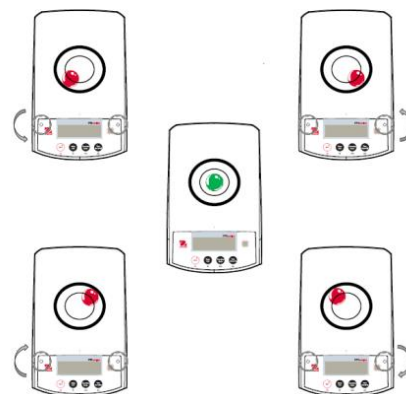

Akklimatisierung

Es wird empfohlen, die Waage nicht zu benutzen, bevor sie für eine gewisse Zeit an die Umgebung akklimatisiert wurde. Im Falle einer Waage mit einer Genauigkeit von über 0,1 mg sollte die Vorakklimatisierungszeit 1,5 Stunden betragen; im Falle einer Waage mit einer Genauigkeit von 1 mg sollte die Akklimationierungszeit mehr als 0,5 Stunden betragen.

2.5 Schnittstellenanschluss

Die PR-Waage verfügt über einen RS232-Anschluss.

Verwenden Sie den RS-232-Anschluss, um entweder mit einem Computer oder einem Drucker über ein serielles (Straight-Through) Standardkabel zu verbinden.

Schnittstellenanschlüsse auf der Rückseite der Waage



RS232

RS232: Wird zum Anschluss an einen PC oder Drucker verwendet

Hinweis: Siehe Drucken-Abschnitt, für Informationen zum Anschließen, Konfigurieren und Testen der Drucker- / Computerschnittstelle.

2.6 Erstkalibrierung

Wenn die PR-Waage zum ersten Mal installiert oder an einen anderen Ort gebracht wird, muss sie kalibriert werden, um genaue Wägeregebnisse zu gewährleisten. PR-Waagen werden in zwei Kategorien unterteilt: InCal-Modelle und ExCal-Modelle. InCal-Modelle verfügen über einen integrierten Kalibrierungsmechanismus, der die Waage automatisch kalibrieren kann und die Verwendung von externen Kalibrierungsmassen nicht erforderlich macht. Bei Bedarf können InCal-Modelle auch manuell mit externen Massen kalibriert werden. ExCal-Modelle werden mit externen Massen kalibriert. Stellen Sie vor Beginn der Kalibrierung sicher, dass die entsprechenden Kalibriermassen verfügbar sind.





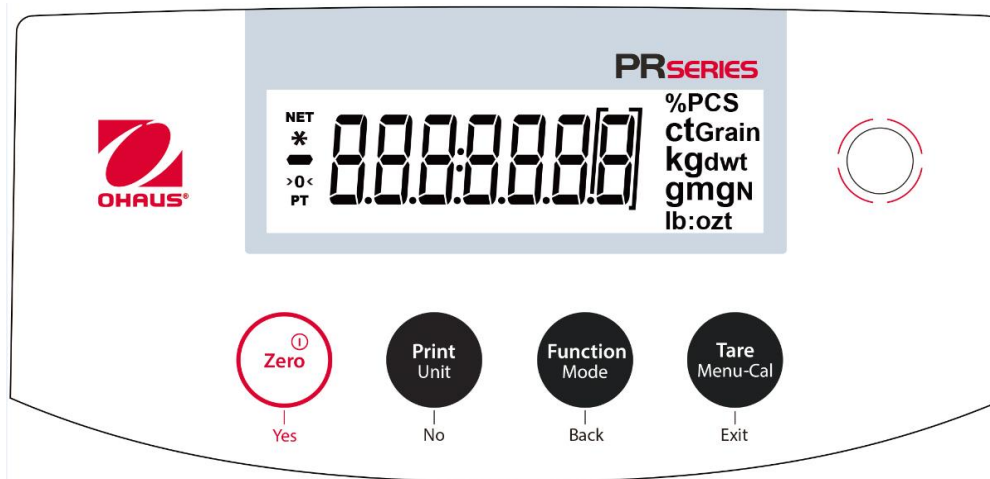

3. BETRIEB

3.1 Überblick über das Display und den Home-Bildschirm

STEUERUNGEN



STEUERUNGSFUNKTIONEN

Taste	 Yes	 No	 Back	 Exit
Primärfunktion (Kurz drücken) 	Ein / Null <ul style="list-style-type: none"> • Wenn die Anzeige ausgeschaltet ist, wird die Anzeige eingeschaltet. • Wenn die Anzeige eingeschaltet ist, wird sie auf Null gesetzt. 	Druck <ul style="list-style-type: none"> • Sendet den aktuell angezeigten Wert an die serielle Schnittstelle. 	Funktion <ul style="list-style-type: none"> • Der Betrieb hängt vom Anwendungsmodus ab. 	Tara <ul style="list-style-type: none"> • Führt den Tarabetrieb aus.
Sekundärfunktion (Drücken und halten) 	Aus <ul style="list-style-type: none"> • Nullt den aktuellen Wert. 	Einheit <ul style="list-style-type: none"> • Ändert die Wiegeeinheiten. 	Modus <ul style="list-style-type: none"> • Ändert den Anwendungsmodus. 	Menu-Cal <ul style="list-style-type: none"> • Ruft das Hauptmenü auf. Die Kalibrierung ist das erste Untermenü. • Zeigt den voreingestellten Tarawert an.
Menüfunktion (Kurz drücken) 	Ja <ul style="list-style-type: none"> • Akzeptiert die aktuelle (blinkende) Einstellung auf dem Display. 	Nein <ul style="list-style-type: none"> • Lehnt die aktuelle (blinkende) Einstellung auf dem Display ab. • Erhöht einen eingegebenen Wert. 	Zurück <ul style="list-style-type: none"> • Kehrt zum vorherigen Menüpunkt zurück. • Verringert einen eingegebenen Wert. 	Exit <ul style="list-style-type: none"> • Verlässt sofort das Untermenü. • Bricht eine laufende Kalibrierung ab.

HAUPTANWENDUNGSBILDSCHIRM



3.2 Hauptfunktionen und Hauptmenü

- Wiegen:** Drücken Sie zuerst **Null** um das Display auf Null zu stellen. Legen Sie ein Objekt auf die Schale. Das Display zeigt das Bruttogewicht an.
- Tara-Einstellung:** Drücken Sie, ohne die Schale zu belasten **Null** um die Anzeige auf Null zu stellen. Stellen Sie einen leeren Behälter auf die Schale und drücken Sie **Tara**. Fügen Sie dem Behälter Objekte hinzu, und sein Nettogewicht wird angezeigt. Nachdem der Behälter und die Objekte entfernt wurden, wird die Ladung als negative Zahl angezeigt. Drücken Sie **Tara**, um zu löschen.
- Null:** Drücken Sie **Null** um das Waage auf Null zu stellen.

3.3 Überblick über Teile und Funktionen - Windschutzmodus

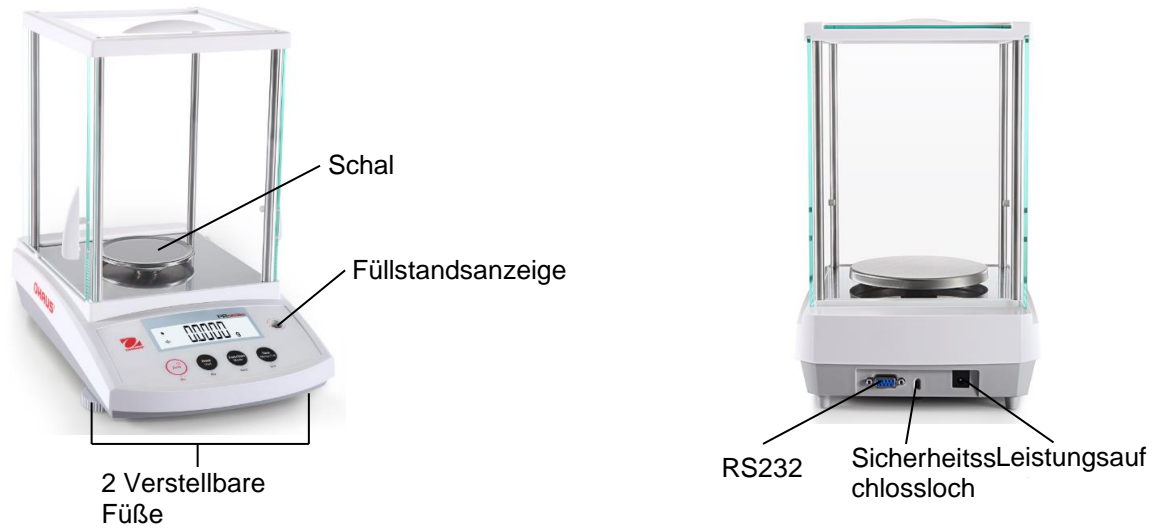

3.4 Überblick über Teile und Funktionen - Modelle ohne Windschutzschild



4. ANWENDUNGEN



Die PR Waage kann in 3 Anwendungsmodi durch langes Drücken der **Funktion / Modus**-Taste bedient werden.

4.1 Wägung

Hinweis: Bevor Sie eine Anwendung verwenden, vergewissern Sie sich, dass die Waage kalibriert wurde.

Verwenden Sie diese Anwendung, um das Gewicht von Artikeln in der ausgewählten Maßeinheit zu bestimmen.

Wägung

<ol style="list-style-type: none"> 1. Drücken Sie Tare oder Zero wenn nötig um zu beginnen. 2. Drücken und halten Sie die Function / Mode-Taste, um WEIEN auszuwählen (diese Anwendung ist die Standardeinstellung). 	
<ol style="list-style-type: none"> 3. Legen Sie Objekte auf die Waagschale, um das Gewicht anzuzeigen. Wenn die Ablesung stabil ist, erscheint das *. 4. Der resultierende Wert wird in der aktiven Maßeinheit angezeigt. 	

Objekteinstellungen

Aktuelle Einstellungen anzeigen oder anpassen.





- **Wiegeeinheiten:** Ändern Sie die angezeigte Einheit. Siehe Abschnitt 5.4 für die detaillierten Prozesse.
- **Filterebene:** Ändern Sie die Filterebene. Siehe Abschnitt 5.3.2 für weitere Informationen.
- **GLP-Daten:** Siehe Abschnitt 5.7 für weitere Informationen.
- **Druckeinstellungen:** Druckeinstellungen ändern. Siehe Abschnitt 7 für weitere Informationen.

4.2 Stückzählung

Hinweis: Bevor Sie eine Anwendung verwenden, vergewissern Sie sich, dass die Waage kalibriert wurde. Das Mindeststückgewicht sollte nicht kleiner als 0,1d betragen. Im LFT-Modus beträgt das minimale Stückgewicht 3e, die minimale Probengröße 10.

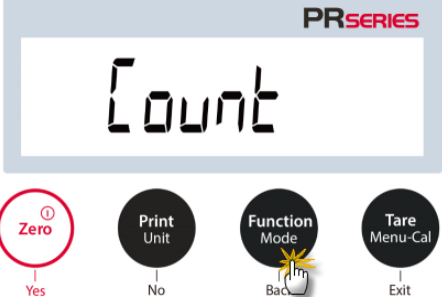
Verwenden Sie diese Anwendung, um Proben mit einem einheitlichen Gewicht zu zählen.

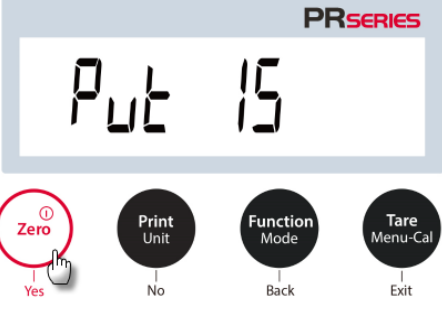
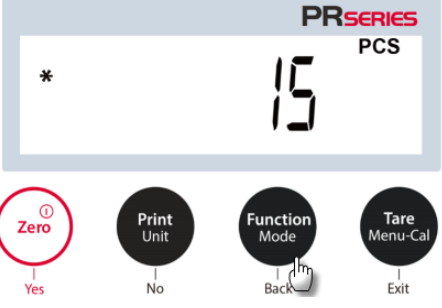
Stückzählung

<p>1. Drücken Sie Tare oder Zero wenn nötig um zu beginnen.</p> <p>2. Drücken und halten Sie die Function / Mode-Taste bis Zählung erscheint.</p>	
<p>3. Nach der Bestätigung durch Drücken von Yes, erscheint die Mitteilung Clr.APW auf dem Bildschirm.</p>	
<p>4. Drücken Sie Yes, und die Mitteilung Pwt 15 erscheint auf dem Display mit der blinkenden (Standard) Zahl 15. Der Benutzer kann No oder Back drücken, um den Wert zu erhöhen oder zu verringern.</p> <p>Um beispielsweise den Wert auf 15 zu erhöhen, drücken Sie bitte No. Dann werden gleichzeitig Pwt und 15 gleichzeitig blinken.</p>	
<p>5. Stellen Sie 15 Proben auf die Schale. Drücken Sie die Function / Mode Taste, so dass das Gewicht der 15 Proben verwendet wird, um das durchschnittliche Stückgewicht (APW) festzustellen. Das Display zeigt 15 Stücke an.</p>	
<p>6. Entfernen Sie die 15 Proben von der Schale und legen Sie weitere Proben auf die Schale. Die entsprechende Anzahl von Stücken wird auf dem Bildschirm angezeigt.</p>	

<p>7. Um das Gesamtgewicht oder die Anzahl der Objektstücke anzuzeigen, drücken Sie die Function / Mode Taste.</p>	
---	--

Objekteinstellungen

Aktuelle Einstellungen anzeigen oder anpassen.

<p>Probe: Die Stichprobengröße liegt zwischen 1 und 100. Der Standardwert ist 10.</p> <p>Hinweis: Wenn das APW der letzten Teilezähloperation beibehalten werden muss, kann der Benutzer No drücken, wenn das Display die Mitteilung CLr.APW anzeigt (Durchschnittliches Stückgewicht löschen). Legen Sie weitere Objekte auf die Schale, und die entsprechende Anzahl von Teilen wird angezeigt.</p>	
---	--

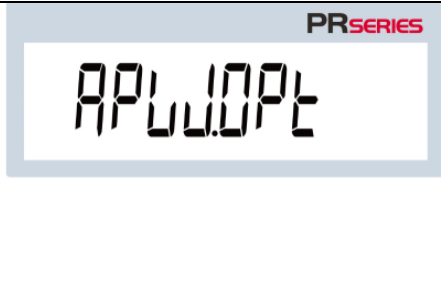
<p>APW-Optimierung: Verbesserung der Zählgenauigkeit durch automatische Neuberechnung des Stückgewichts bei Hinzufügung von Teilen. Die APW-Optimierung wird nur ausgeführt, wenn die Anzahl der der Schale hinzugefügten Teile zwischen dem Einfachen und dem Dreifachen der Anzahl liegt, die sich bereits auf der Schale befindet.</p> <p>Druckeinstellungen: Änderung der Druckeinstellung. Siehe Abschnitt 7 für weitere Informationen.</p>	
--	---







4.3 Prozent Wägung

Hinweis: Bevor Sie eine Anwendung verwenden, vergewissern Sie sich, dass die Waage kalibriert wurde.

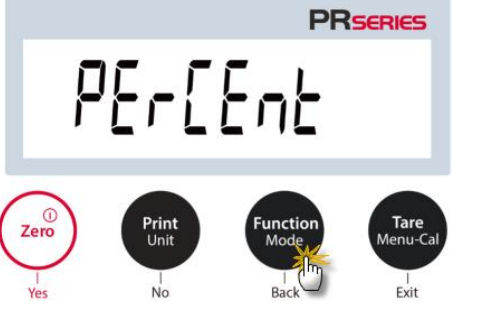
Verwenden Sie das Prozentwiegen, um das Gewicht eines Testobjekts als einen Prozentsatz einer zuvor festgelegten Referenzprobe anzuzeigen.

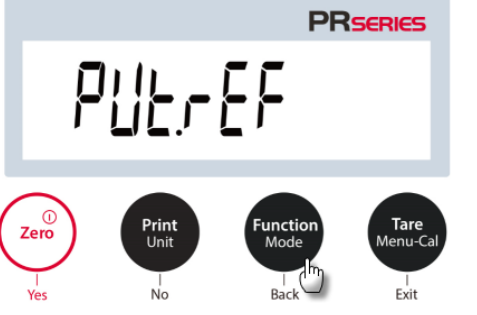
Das standardmäßige (oder das letzte) Referenzgewicht wird angezeigt.

Prozent Wägung

<p>1. Drücken und halten Sie die Function / Mode-Taste bis PERCENT erscheint.</p>	
<p>2. Nach Bestätigung durch Drücken von Yes, erscheint die Mitteilung CLREF (Referenz löschen) auf dem Bildschirm.</p>	
<p>3. Drücken Sie Yes, und PULREF (Referenzgewicht aufstellen) wird angezeigt</p>	
<p>4. Legen Sie die Referenzprobe auf die Schale, um das Gewicht anzuzeigen. Wenn die Ablesung stabil ist, erscheint das *. 5. Drücken Sie die Function / Mode Taste, so dass das Gewicht der Referenzproben im Speicher abgelegt wird. Das Display zeigt 100.0000% an.</p>	
<p>6. Entfernen Sie die Referenzprobe und legen Sie das Testobjekt auf die Schale. Das Verhältnis des Testobjekts zum Referenzprobengewicht wird in Prozent angezeigt.</p>	
<p>7. Um das Referenzprobengewicht oder den Prozentsatz des Testobjektgewichts zum Referenzprobengewicht anzuzeigen, drücken Sie die Function / Mode Taste.</p>	

8. Um ein neues Referenzprobengewicht zu ermitteln, drücken Sie lange auf **Function / Mode** und wiederholen Sie die oben beschriebenen Schritte.

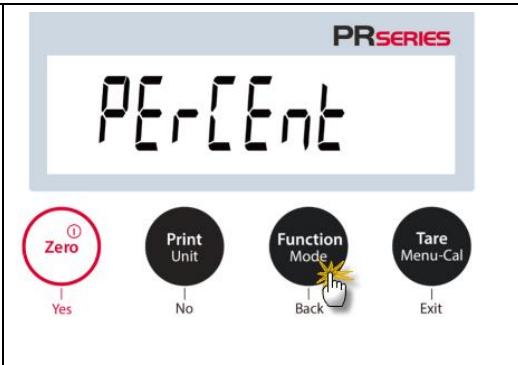

Objekteinstellungen

Hinweis: Wenn das Referenzgewicht der letzten Prozentwiegung beibehalten werden soll, drücken Sie **No** wenn die Nachricht **REF** (Referenz löschen) angezeigt wird.



Druckeinstellung:

Änderung der Druckeinstellung. Siehe Abschnitt 7 für weitere Informationen.

4.4 Zusatzfunktionen

Unterflur wiegen

Hinweis: Stellen Sie sicher, dass die Waage nivelliert und kalibriert wurde.

Die PR-Waage ist mit einer Wiegefunktion unterhalb des Hakens ausgestattet, um unter der Waage zu wiegen (siehe unten).

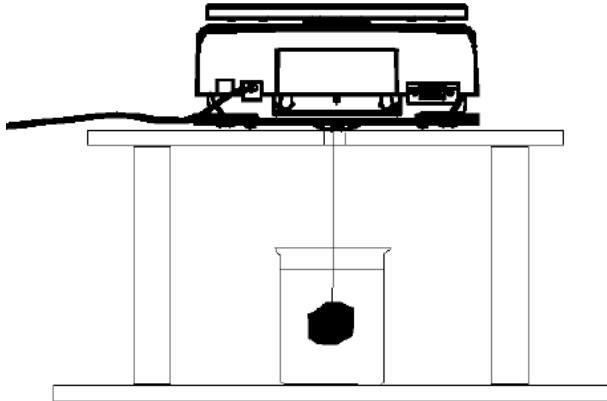

Bevor Sie die Waage umdrehen, entfernen Sie die Wägeschale und die Windschutzelemente (falls vorhanden), um Schäden zu vermeiden. Stellen Sie die Waage nicht auf die Schalenstütze oder die Lastzellenstifte.

Um diese Funktion zu nutzen, trennen Sie die Stromversorgung von der Waage und entfernen Sie dann die Schutzabdeckung für den Unterflurwägehaken.

Schalten Sie die Waage ein und verwenden Sie dann eine Schnur oder einen Draht, um die zu wiegenden Gegenstände zu befestigen.



Schutzabdeckung des Unterflurwägehakens



Unterflurwägehaken

5. MENÜEINSTELLUNGEN

5.1 Menünavigation

Kalibrierung	Konfiguration	Einheit	RS232	Druck	GLP	Zurücksetzen	Sperrungen
InCal	Filterebene	Gramm	Baudrate	Nur stabil	Kopfzeile 1	Alles zurücksetzen	Kalibrierung
Cal Anpassen	AZT	Kilogramm	Parität	Nur numerisch	Kopfzeile 2		Konfiguration
Spannen Kal	Auto Tara	Milligramm	Handschlag	Einzelne Kopfzeile	Kopfzeile 3		RS232
Linearität Kal	Abstufungen	Karat		Auto Druck	Waage-Name		Druck
	Datumsformat	Pfund		Kopfzeile	Benutzername	GLP	
	Datumseinstellung	Unze		Datum und Uhrzeit	Name des Projekts	Zurücksetzen	
	Zeitformat	Feinunze		Waage-ID			
	Zeiteinstellung	Penny Weight *		Waage-Name			
	Helligkeit	Newton		Benutzername			
	Auto Dim	Taiwan Tael		Name des Projekts			
	LFT	Custom 1		Name der Anwendung			
		Korn		Ergebnis			
				Bruttogewicht			
		Nettogewicht					
		Eigengewicht					
		Unterschriftenzeile					
		Zeilenvorschub					

*Das Penny-Gewicht ist für das NTEP-Modell nicht verfügbar.

5.1.1 Einstellungen ändern

Um eine Menüeinstellung zu ändern, navigieren Sie mithilfe der folgenden Schritte zu dieser Einstellung:

Zugriff auf das Menü

Drücken Sie die Menütaste lange, um das **Menü** aufzurufen.

Wählen Sie das Untermenü aus

Drücken Sie **Nein**, um zwischen den Untermenüs zu wechseln und drücken Sie **Ja** um in das Untermenü zu gelangen.

Wählen Sie den Menüpunkt aus

Drücken Sie **Nein** um durch die Menüpunkte zu wechseln und drücken Sie **Ja** um den angezeigten Menüpunkt zu öffnen.

5.2 alibrierung

PR-Waagen bieten eine Auswahl von drei Kalibrierungsmethoden: Interne Kalibrierung (nur für InCal-Modelle), Spannenkalibrierung und Linearitätskalibrierung.

Achtung: Stören Sie die Waage während der Kalibrierung nicht.

5.2.1 Kalibrierungsuntermenü (InCal-Modelle)

Hinweis: ExCal-Modelle verfügen nur über eine Spannenkalibrierung und eine Linearitätskalibrierung.

5.2.2 Interne Kalibrierung (gilt nicht für ExCal-Modelle)

Die Kalibrierung wird mit der internen Kalibriermasse durchgeführt. Die interne Kalibrierung kann jederzeit durchgeführt werden, vorausgesetzt, die Waage hat sich auf Betriebstemperatur erwärmt und ist nivelliert. Drücken Sie die **Tare / Menu-Cal** Taste, geben Sie die interne Kalibrierungseinstellung ein. Oder drücken Sie die Taste **Tare / Menu-Cal** und wählen Sie **InCAL**, um die interne Kalibrierung zu starten.

Festlegen der internen Kalibrierungsfunktionalität.		InCAL Incal
On = Aktiviert. Off = Deaktiviert. Incal = Die interne Kalibrierung zu starten		
ON Aktiviert	OFF Deaktiviert	InCAL Interne kalibrierung

Der Bildschirm zeigt den Status. Drücken Sie eine beliebige Taste, um zum vorherigen Bildschirm zurückzukehren.

5.2.3 Cal Anpassung (gilt nicht für ExCal-Modelle)

Verwenden Sie diese Kalibrierungsmethode, um die Wirkung der internen Kalibrierung feineinzustellen. Mit Kalibrierung anpassen kann das Ergebnis der internen Kalibrierung um ± 100 Divisionen eingestellt werden.

Hinweis: Bevor Sie eine Kalibrierung vornehmen, führen Sie eine interne Kalibrierung durch. Um zu überprüfen, ob eine Anpassung erforderlich ist, platzieren Sie ein Prüfgewicht gleich dem **Spannenkalibrierwert** auf der Wägeplattform und notieren Sie die Differenz (in Divisionen) zwischen dem Nennmassenwert und der tatsächlichen Waageablesung. Wenn die Differenz innerhalb der +/- Division liegt, ist keine Kalibrierungsanpassung erforderlich. Wenn die Differenz die +/- 1 Division überschreitet, wird eine Kalibrierung empfohlen.

Beispiel:

Erwartete Gewichtsablesung:	200,000 (Testmassenwert)
Tatsächliches Gewichtsablesung:	200,014
Differenz in Gramm:	- 0,014
Differenz in Division:	- 14 (InCal Anpasswert)

Um eine Kalibrierungseinstellung durchzuführen, wählen Sie InCal Adjustment aus der Liste des Kalibrierungsmenüs; geben Sie den Wert ein (positive oder negative Divisionen), um den zuvor beschriebenen Unterschied zu berücksichtigen.

Neukalibrierung unter Verwendung der internen Kalibrierung. Stellen Sie nach der Kalibrierung die Testmasse auf die Schale und vergewissern Sie sich, dass der Massenwert jetzt dem angezeigten Wert entspricht. Wenn nicht, wiederholen Sie den Vorgang, bis der Wert für die interne Kalibrierung mit der Testmasse übereinstimmt.

Nach Abschluss speichert die Waage den Einstellwert und die Anzeige kehrt zur aktuellen Anwendung zurück.

5.2.4 Spannenkalibrierung

Die Spannenkalibrierung verwendet zwei Kalibrierungspunkte, einen bei **Nulllast** und den anderen bei **festgelegter Vollast** (Spanne). Für detaillierte Informationen zur Kalibriermasse, siehe Spezifikationstabellen in "Spanne Kalibrierungspunkte", SPEZIFIKATIONEN, Abschnitt 9. Die Spannenkalibrierung kann bei eingeschalteter Waage und ohne Last auf der Schale durchgeführt werden. Weitere zu verwendende Kalibrierwerte werden auf dem Display angezeigt. Die beste Genauigkeit wird erreicht, indem die Masse verwendet wird, die dem vollen Spannenwert am nächsten kommt.

Schritte für die Spannenkalibrierung

<p>1. Drücken und halten Sie die Taste Tare / Menu-Cal, und das Kalibrierungsmenü wird angezeigt.</p>	
<p>2. Drücken Sie Yes um das Kalibrierungsmenü aufzurufen.</p>	
<p>3. Um den Kalibrierungsmodus zu ändern, drücken Sie No bis SPAN (Spanne Kalibrierung) angezeigt wird.</p>	
<p>4. Der Kalibrierungsmassenwert wird auf dem Bildschirm angezeigt. Nachdem das Display 200.0000 g anzeigt, stellen Sie bitte Gewicht(e) von 200 g auf die Waagschale für die Kalibrierung. Um zum Kalibrierungspunkt mit halber Kapazität (z. B. 100 g) zu wechseln, drücken Sie die Function / Mode Taste. Wenn 0,0000 g angezeigt wird, nehmen Sie bitte die Masse weg.</p>	
<p>5. Sobald die Kalibrierung erfolgreich abgeschlossen ist, wird CALdone angezeigt. Drücken Sie eine beliebige Taste, um zum vorherigen Bildschirm zurückzukehren.</p>	
<p>6. Entfernen Sie das Gewicht und der Messwert wird auf Null gesetzt.</p>	

5.2.5 Linearität Kalibrierung





Die Linearitätskalibrierung verwendet drei Kalibrierungspunkte, einen bei Nulllast und die anderen bei festgelegten Lasten.

Drücken Sie die Linearitätskalibrierung, um den Prozess zu starten, ohne Last auf der Waage

Die Waage erfasst den Nullpunkt und verlangt dann nach dem nächsten Gewicht.

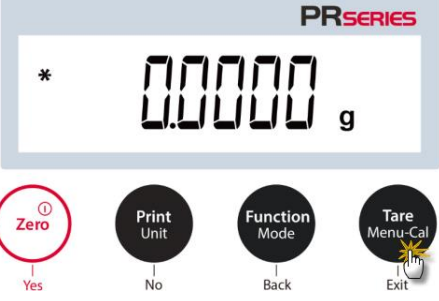
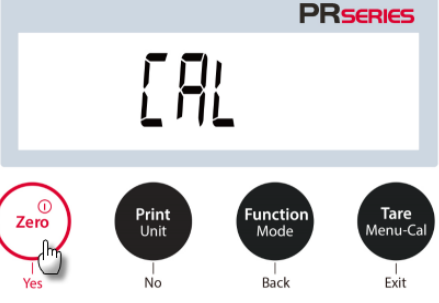
Folgen Sie den Anweisungen auf dem Display, bis die Kalibrierung abgeschlossen ist.

Schritte für die Linearitätskalibrierung

<p>1. Drücken und halten Sie die Taste Tare / Menu-Cal, und das Kalibrierungsmenü wird angezeigt.</p>	
<p>2. Drücken Sie Yes um das Kalibrierungsmenü aufzurufen.</p>	
<p>3. Um den Kalibrierungsmodus zu ändern, drücken Sie No, bis LINEAR (Spanne Kalibrierung) angezeigt wird.</p>	
<p>4. Der Kalibrierungsmassenwert wird auf dem Display angezeigt. Nachdem das Display 100.0000 g anzeigt, stellen Sie bitte Gewicht(e) von 100 g zur Kalibrierung auf die Schale.</p>	
<p>5. Entfernen Sie das Gewicht von 100 g von der Schale. Nach einer Weile, werden 200.0000 g auf dem Bildschirm angezeigt. Bitte legen Sie zur Kalibrierung ein Gewicht von 200 g auf die Schale.</p>	
<p>6. Sobald die Linearitätskalibrierung erfolgreich abgeschlossen ist, wird CALdone angezeigt. Drücken Sie eine beliebige Taste, um zum vorherigen Bildschirm zurückzukehren.</p>	

<p>7. Entfernen Sie das Gewicht und der Messwert wird auf Null gesetzt.</p>	
---	---

5.3 Waageneinstellung

Rufen Sie dieses Untermenü auf, um die Waagenfunktionalität anzupassen.

Hinweis: Die werkseitigen Standardeinstellungen werden unten in **Fett** angezeigt.

5.3.1 Filterebene

<p>Stellen Sie den Umfang der Signalfilterung ein.</p>		<p>F I L T E R</p>
<p>Gering = schnellere Stabilisierungszeit bei geringerer Stabilität. Medium = normale Stabilisierungszeit bei normaler Stabilität. Hoch = langsamere Stabilisierungszeit bei mehr Stabilität.</p>		
<p>Low Gering</p>	<p>Med Medium</p>	<p>HIGH Hoch</p>

5.3.2 AZT (Automatische Nullpunktverfolgung)

<p>Stellt die automatische Nullpunktverfolgung ein.</p>		<p>A Z T (Automatische Nullpunktverfolgung)</p>
<p>Off = deaktiviert. 0,5 d = Display hält Null bis zu einer Abweichung von 0,5 Abstufungen pro Sekunde. 1 d = Display hält Null bis zu einer Verschiebung von 1 Abstufung pro Sekunde. 3 d = Display hält Null bis zu einer Verschiebung von 3 Abstufung pro Sekunde.</p>		
<p>0.5 d 0,5 d</p>	<p>1 d 1 d</p>	<p>3 d 3 d</p>

5.3.3 Auto Tara

<p>Stellt die automatische Tara ein.</p> <p>Wenn Automatische Tara auf Ein gestellt ist, wird das erste auf die Schale platzierte Objekt als Behälter betrachtet und automatisch tariert.</p> <p>Off = deaktiviert. On = aktiviert.</p>		
<p>A.T.A.R.E Auto Tara</p>	<p>OFF Off</p>	<p>ON On</p>

5.3.4 Abstufungen

Stellt die angezeigte Lesbarkeit der Waage ein.

1 Division = Standardlesbarkeit.

10 Divisionen = Lesbarkeit ist um den Faktor 10 erhöht.

Wenn die Standardlesbarkeit beispielsweise 0,01 g beträgt, ergibt die Auswahl von 10 Divisionen einen Wert von 0,1 g.

0rAd	1 d	10 d
Abstufung	1 Division	10 Division

5.3.5 Datumsformat

Stellen Sie das aktuelle Datumsformat ein.

Datumsformat:
JJ/MM/TT
MM/TT/JJ
TT/MM/JJ

d.Foꝛꝛꝛt	ꝛꝛꝛꝛ
Datumsformat	MM/TT/JJJJ
dꝛꝛꝛ	ꝛꝛꝛꝛ
DD/MM/JJJJ	JJJJ/MM/TT

5.3.6 Datumseinstellung

Stellen Sie das aktuelle Datum im gewünschten Datumsformat ein.

Um das aktuelle Datum einzustellen, drücken Sie **Nein** oder **Ja** um den Wert zu erhöhen oder zu verringern.

Wenn das aktuelle Datum zum Beispiel der 22. Juni 2017 ist, MM/TT/JJ: 06. 22. 17 DD/MM/JJ: 22. 06. 17 JJ/MM/TT: 17. 06. 22	dAtE
	Datum
	06.22.17

5.3.7 Zeitformat

Stellen Sie das Zeitformat ein.

Zeitformat:
24hr
12hr

t.Foꝛꝛꝛt	24 hr	12 hr
Zeitformat	24hr	12hr

5.3.8 Zeiteinstellung

Stellen Sie die aktuelle Uhrzeit im gewünschten Zeitformat ein.	17:17
Um die aktuelle Uhrzeit einzustellen, drücken Sie Nein oder Ja um den Wert zu erhöhen oder zu verringern.	08.00.00

5.3.9 Helligkeit

Stellen Sie die Helligkeit des Displays ein. Medium Hoch Gering	br 19ht Helligkeit	17Ed Medium
	HIGH High	Low Gering

5.3.10 Auto Dim

Stellen Sie ein, ob die Waage die Hintergrundbeleuchtung des Displays automatisch ausschaltet.	Aut.d 17	
Aus = deaktiviert. 10 Minuten = verdunkelt sich, wenn 10 Minuten lang keine Bewegung erfolgt. 20 Minuten = verdunkelt sich, wenn 20 Minuten lang keine Bewegung erfolgt. 30 Minuten = verdunkelt sich, wenn 30 Minuten lang keine Bewegung erfolgt.		
10 17.1 10 min	20 17.1 20 min	30 17.1 30 min

5.3.11 Genehmigt-Modus

Verwenden Sie dieses Menü, um den Status "Eichpflichtig" festzulegen. OFF = Standardbetrieb. ON = Betrieb entspricht den gesetzlichen Vorschriften für das Messwesen.	LFE
--	-----

Für PRxxxN-Modelle:

Verwenden Sie dieses Menü, um den Status "Eichpflichtig" festzulegen. OFF = Standardbetrieb. ON 1d = Betrieb entspricht den gesetzlichen Vorschriften für das Messwesen, e=1d. ON 10d = Betrieb entspricht den gesetzlichen Vorschriften für das Messwesen, e=10d.	LFE
--	-----

Hinweis: Wenn der Genehmigt-Modus aktiviert ist, sind die Menüeinstellungen wie folgt betroffen:

Kalibrierungsmenü:

- Für InCal-Modelle ist nur die interne Kalibrierung verfügbar. Alle anderen Funktionen werden ausgeblendet.

Waageeinstellungs-Menü:

- Die Filterebene ist bei der aktuellen Einstellung gesperrt.
- Die automatische Nullpunktverfolgung ist auf 0,5 Abschnitt und Aus begrenzt. Die ausgewählte Einstellung ist gesperrt.
- Die automatische Tara ist bei der aktuellen Einstellung gesperrt.
- Graduierungen werden zu 1 Abschnitt gezwungen und der Menüpunkt ist ausgeblendet.

Kommunikationsmenü (Kommunikation-> Druckeinstellungen-> Druckausgabe):

- "Nur stabiles Gewicht" ist gesperrt.
- "Nur Numerischer Wert" ist gesperrt.

Kommunikationsmenü (Kommunikation-> Druckeinstellungen-> Automatischer Druck):

- Die Auswahl des Automatischen Druckmodus ist auf Aus, Bei Stabilität und Intervall beschränkt. Dauerhaft ist nicht verfügbar.

Sperrmenü:

- Menü ist ausgeblendet

5.4 Wiegeeinheiten

Rufen Sie dieses Untermenü auf, um die gewünschten Maßeinheiten zu aktivieren.



PR-Waagen bieten eine Auswahl von 12 Einheiten, die standardmäßig eingeschaltet sind.

Hinweis: Aufgrund nationaler Gesetze kann die Waage einige der unten aufgeführten Maßeinheiten nicht enthalten.

NTEP-Modell: Das Menü „Unit“ wird zur Aktivierung bzw. Deaktivierung einer spezifischen Einheit verwendet. (SET ON, SET OFF).

Einheit	Display
Gramm	g
Kilogramm	kg
Milligramm	mg
Karat	ct
Pfund	lb
Unze	oz
Feinunze	ozt
Pennyweight	dwt
Newton	N
TW Tael	t
Custom 1	C
Korn	GN

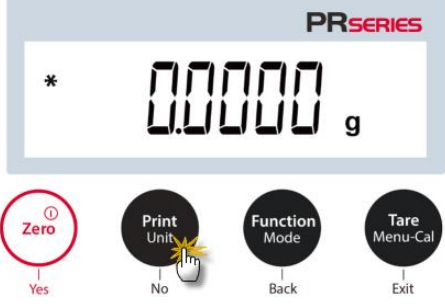
Wechsel der Wiegeeinheiten

<p>1. Drücken und halten Sie die Taste Print / Unit Knopf bis das <i>Einheitenmenü</i> angezeigt wird.</p>	
<p>2. Die Standardeinheit ist Gramm (g). Um das Gerät zu wechseln, drücken Sie No um zur nächsten Einheit zu gelangen.</p>	
<p>3. Drücken Sie Yes um die angezeigte Einheit auf die Wiegeeinheit einzustellen.</p>	

5.5 RS232-Schnittstellenkonfiguration

<p>Rufen Sie dieses Untermenü auf, um die RS232-Standard Einstellungen anzupassen. Daten können entweder an einen Drucker oder an einen PC ausgegeben werden.</p>	
---	--

5.5.1 Baudrate

<p>Stellt die Baudrate (Bits pro Sekunde) ein.</p>	
<p>1200 = 1200 bps 2400 = 2400 bps 4800 = 4800 bps 9600 = 9600 bps 19200 = 19200 bps 38400 = 38400 bps</p>	

5.5.2 Übertragung

<p>Stellt die Datenbits, das Stoppbit und die Parität ein. 8-N-1 = 8 Datenbits, keine Parität, Stoppbit 1 8-N-2 = 8 Datenbits, keine Parität, Stoppbit 2 7-E-1 = 7 Datenbits, ungerade Parität, Stoppbit 1 7-E-2 = 7 Datenbits, ungerade Parität, Stoppbit 2</p>

7-N-1 = 7 Datenbits, keine Parität, Stoppbit 1 7-N-2 = 7 Datenbits, keine Parität, Stoppbit 2 7-O-1 = 7 Datenbits, ungerade Parität, Stoppbit 1 7-O-2 = 7 Datenbits, ungerade Parität, Stoppbit 2	
PARITY Parität	8-N-1 8 Datenbits, Stoppbit 1

5.5.3 Handschlag

Legt die Flusssteuerungsmethode fest. NON= kein Handschlag XON-XOFF = XEIN/XAUS-Handschlag HARDWARE= Hardware-Handschlag	
H.SHAPE Handschlag	NONE Keiner
ON-OFF Xein / Xaus	HARDWARE Hardware

5.6 Druckeinstellungen

Betreten Sie dieses Untermenü, um die Datenübertragungseinstellungen einzustellen.	Print
--	--------------

5.6.1 Nur stabil

Off = Werte werden unabhängig von der Stabilität sofort gedruckt. On = Werte werden nur gedruckt, wenn die Stabilitätskriterien erfüllt werden.	STABLE
---	---------------

5.6.2 Nur numerisch

Off = Alle ausgewählten Ergebnisse werden gedruckt. On = Nur numerische Datenwerte werden gedruckt.	NUM
---	------------

5.6.3 Einzelne Kopfzeile

Off = Für jede Druckanforderung werden Kopfzeilen gedruckt. On = Die Kopfzeilen werden einmal am Tag gedruckt.	S in.HEAD
--	------------------

5.6.4 Auto Druck

Aktivieren oder deaktivieren Sie die Funktionalität des automatischen Drucks und legen Sie den spezifischen automatischen Druckmodus fest.	A.Pr int
1. Aus= deaktiviert	OFF
2. Bei Stabilität = der Druck erfolgt, wenn die Stabilitätskriterien erfüllt werden.	ON.StAb
Wenn "Bei Stabilität" ausgewählt ist, legen Sie die Bedingungen für das Drucken fest. Last = Druckt, wenn die angezeigte Last stabil ist.	LoAd
Last und Null = Druckt, wenn die angezeigte Last- und die Nullablesung stabil sind.	LoAd.zEr
3. Druckintervall = Druck erfolgt im definierten Zeitintervall. Wenn Druckintervall ausgewählt ist, legen Sie das Zeitintervall über die Nummerntastatur fest. Hinweis: Einstellungen von 1 bis 3600 Sekunden sind verfügbar. Standard ist 0.	IntEr
4. Dauerhaft = Druck erfolgt kontinuierlich.	Cont inu

5.6.5 Kopfzeile

On = Die Kopfzeile wird gedruckt. Off = die Kopfzeile wird nicht gedruckt.	HEAdEr
--	--------

5.6.6 Datum und Uhrzeit

On = Das Datum und die Uhrzeit werden gedruckt. Off = weder das Datum noch die Uhrzeit werden gedruckt.	dtTm
---	------

5.6.7 Waage-ID

<p>On = die Waage-ID wird gedruckt. Off = die Waage-ID wird nicht gedruckt.</p>	<p>6AL 1d</p>
--	---------------

5.6.8 Waage-Name

<p>On = der Waage-Name wird gedruckt. Off = der Waage-Name wird nicht gedruckt.</p>	<p>6AL.NAM7</p>
--	-----------------

5.6.9 Benutzername

<p>On = der Name des Benutzers wird gedruckt. Off = der Name des Benutzers wird nicht gedruckt.</p>	<p>USr.NAM7</p>
--	-----------------

5.6.10 Name des Projekts

<p>Ein = der Projektname wird gedruckt. Aus = der Projektname wird nicht gedruckt.</p>	<p>Prj.NAM7</p>
---	-----------------

5.6.11 Name der Anwendung

<p>On = der Name der Anwendung wird gedruckt. Off = der Name der Anwendung wird nicht gedruckt.</p>	<p>APP.NAM7</p>
--	-----------------

5.6.12 Ergebnis

<p>On = das Ergebnis der Wägung wird gedruckt. Off = das Ergebnis der Wägung wird nicht gedruckt.</p>	<p>rESult</p>
--	---------------

5.6.13 Brutto

<p>On = das Bruttogewicht wird gedruckt. Off = das Bruttogewicht wird nicht gedruckt.</p>	<p>Gross</p>
--	--------------

5.6.14 Netto

<p>On = das Nettogewicht wird gedruckt. Off = das Bruttogewicht wird nicht gedruckt.</p>	<p>NET</p>
---	------------

5.6.15 Tare

<p>On = das Taragewicht wird gedruckt. Off = das Bruttogewicht wird nicht gedruckt.</p>	TARE
---	-------------

5.6.16 Unterschriften-zeile

<p>On = Die Signaturzeile wird gedruckt. Off = Die Signaturzeile wird nicht gedruckt.</p>	SIGN.L IN
--	------------------

5.6.17 Zeilenvorschub

<p>1 Zeile = das Papier bewegt sich nach dem Drucken eine Zeile nach oben. 4 Zeilen = das Papier bewegt sich nach dem Drucken vier Zeilen nach oben.</p>	FEED
1 LINE 1 Zeile	4 LINES 4 Zeilen

5.7 GLP

<p>Rufen Sie dieses Menü auf, um die Gute Laborpraxis (GLP) festzulegen.</p>	GLP
--	------------

5.7.1 Kopfzeile

<p>Aktiviert das Drucken von GLP-Kopfzeilen. Es sind bis zu 3 Kopfzeilen verfügbar. Alphanumerische Einstellungen bis zu 16 Zeichen stehen für jede Kopfzeileneinstellung zur Verfügung.</p>	HEADER 1 Kopfzeile 1
HEADER 2 Kopfzeile 2	HEADER 3 Kopfzeile 3

5.7.2 Waage-Name

<p>Geben Sie den Namen der Waage ein. Alphanumerische Einstellungen bis zu 16 Zeichen stehen für jede Kopfzeileneinstellung zur Verfügung.</p>	BAL.NAME
---	-----------------

5.7.3 Benutzername

<p>Geben Sie den Benutzernamen ein. Alphanumerische Einstellungen bis zu 16 Zeichen stehen für jede Kopfzeileneinstellung zur Verfügung.</p>	USR.NAME
---	-----------------

5.7.4 Name des Projekts

<p>Geben Sie den Projektnamen ein.</p> <p>Alphanumerische Einstellungen bis zu 16 Zeichen stehen für jede Kopfzeileneinstellung zur Verfügung. Der Standard ist leer.</p>	
---	---

5.8 Zurücksetzung auf Werkseinstellungen

<p>Verwenden Sie dieses Untermenü, um alle Menüeinstellungen auf die werkseitigen Standardeinstellungen zurückzusetzen.</p> <p>Alles Zurücksetzen = setzt alle Menüs auf die Werkseinstellungen zurück. Exit = kehrt zum Hauptbildschirm der Anwendung zurück, ohne irgendwelche Menüs zurückzusetzen.</p>	
---	---

5.9 Sperrung

<p>Verwenden Sie dieses Untermenü, um bestimmte Menüs zu sperren/entsperren.</p> <p>Off = das Menü ist entsperrt. On = das Menü ist gesperrt.</p>	
--	---

6. EICHPFLICHTIGE ANWENDUNG (LEGAL FOR TRADE, LFT)

Wenn die Waage im Handel oder in einer gesetzlich kontrollierten Anwendung verwendet wird, muss sie entsprechend den örtlichen Eichvorschriften aufgestellt, geprüft und versiegelt werden. Es liegt in der Verantwortung des Käufers, sicherzustellen, dass **alle relevanten gesetzlichen Anforderungen** erfüllt sind.

6.1 Einstellungen

Führen Sie vor der Überprüfung und Versiegelung die folgenden Schritte der Reihe nach durch:

1. Vergewissern Sie sich, dass die Menüeinstellungen den örtlichen Vorschriften für Gewichte und Maße entsprechen.
2. Überprüfen Sie, ob die aktivierten Einheiten den örtlichen Vorschriften für Gewichte und Maße entsprechen.
3. Führen Sie eine Kalibrierung durch, wie im Abschnitt Kalibrierung beschrieben.
4. Rufen Sie das Kalibrierungsmenü auf und stellen Sie die interne Kalibrierung ein, wobei Sie sicherstellen müssen, dass die Geräte den örtlichen Vorschriften für Gewichte und Maße entsprechen.
 - a) Drücken Sie die Taste **Tare / Menu-Cal** und wählen Sie **InCal**.
 - b) Drücken Sie die Taste **Print/Unit**, um die Einstellung für die interne Kalibrierung durch die **On** oder **Off**-Taste ein- oder auszuschalten.
Achtung! Die interne Kalibrierung muss deaktiviert werden, wenn die Waage für den Handel in Kanada verwendet wird.
 - c) Drücken Sie die **Zero**-Taste zur Bestätigung und dann die **Tare / Menu-Cal** -Taste, um das Menü zu verlassen.
5. Aktivieren Sie den Bestätigungsmodus im Waagen-Setup-Menü. Bei Modellen mit wählbarer Teilungsgröße stellen Sie den gewünschten Wert im LFT-Menü ein, wie im Abschnitt **Bestätigungsmodus** dargestellt.
6. Bringen Sie bei Modellen mit Measurement Canada- und NTEP-Zertifizierung und wählbarer Skalengröße das entsprechende Kapazitäts- und Ablesbarkeitsetikett an der Waage an der unten angegebenen Stelle an.
 - a) Entnehmen Sie die den Satz von zwei Etiketten aus der Verpackung.
 - b) Nehmen Sie das Etikett, das der im Menü LFT eingestellten Teilungsgröße entspricht.
 - c) Entfernen Sie die durchsichtige Plastikschutzabdeckung vom Terminal, falls vorhanden.
 - d) Ziehen Sie das Trägermaterial von der Klebefläche ab und kleben Sie das Etikett auf den Bereich oberhalb des Displays.
 - e) Bringen Sie die durchsichtige Plastikschutzabdeckung wieder an, falls vorhanden.

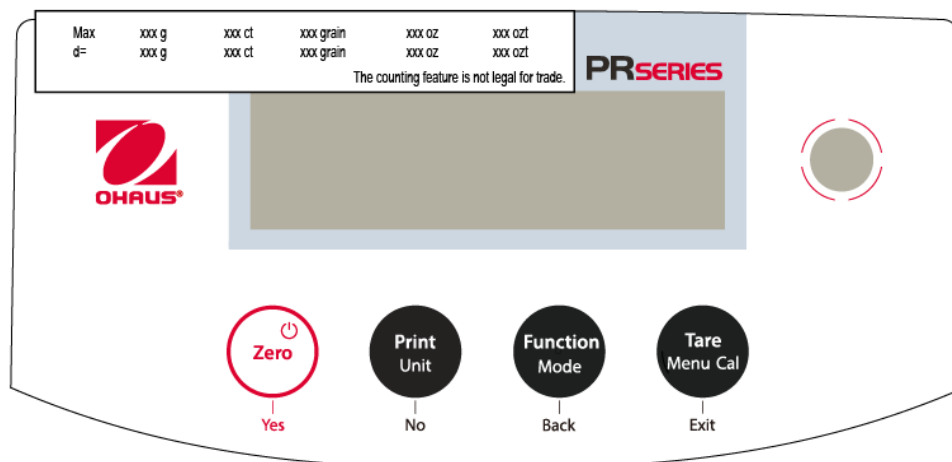

Hinweis: Wenn der Genehmigt-Modus aktiviert ist, kann keine externe Kalibrierung durchgeführt werden.

6.2 Überprüfung

Ein lokaler Eichbeamter oder autorisierter Kundendienstvertreter muss das Prüfverfahren durchführen.

6.3 Versiegelung

Nachdem die Waage überprüft wurde, muss sie versiegelt werden, um einen unerkannten Zugriff auf die gesetzlich kontrollierten Einstellungen zu verhindern. Stellen Sie vor dem Versiegeln des Geräts sicher, dass sich der Sicherheitsschalter in der gesperrten Position befindet und die Genehmigt-Modus-Einstellung im Menü "Waagenkonfiguration" auf "ON" gestellt wurde.

- Wenn Sie eine Papierdichtung verwenden, legen Sie die Dichtung wie abgebildet über den Sicherheitsschalter und das untere Gehäuse.
- Wenn Sie eine Kabeldichtung verwenden, führen Sie den Versiegelungskabel wie gezeigt durch die Löcher im Sicherheitsschalter und im unteren Gehäuse.



Abbildung 6-1. Versiegelung

7. DRUCK

7.1 Anschluss, Konfiguration und Testen der Drucker- / Computerschnittstelle

Verwenden Sie den integrierten RS-232-Anschluss, um entweder eine Verbindung zu einem Computer oder zu einem Drucker herzustellen.

Wenn eine Verbindung zu einem Computer hergestellt wird, verwenden Sie HyperTerminal oder eine ähnliche Software wie SPDC, die weiter unten beschrieben wird.

(HyperTerminal finden Sie unter **Zubehöerteile/Kommunikationen** in Windows XP.)

Schließen Sie den Computer mit einem seriellen Standardkabel (gerade) an.

Wählen Sie **Neue Verbindung**, "Verbinden mit" COM1 (oder verfügbarem COM-Anschluss).

Wählen Sie **Baud=9600; Parität=8 Keine; Stopp=1; Handschlag=Keine**. Klicken Sie **OK**.

Wählen Sie Eigenschaften/Einstellungen und dann ASCII-Setup. Kontrollkästchen wie abgebildet: (**L**inienden senden ...; **E**cho getippte Zeichen ...; **W**ickellinien...)

Benutzen Sie die RS232-Schnittstellenbefehle (Abschnitt 9.6.1), um die Waage von einem PC aus zu steuern.

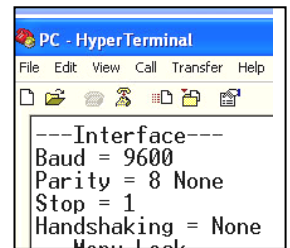

SPDC-Software

Die Serial Port Data Collection / SPDC wird von Ohaus bereitgestellt und kann auf Betriebssystemen verwendet werden, auf denen die oben genannte HyperTerminal-Software nicht installiert ist. Die SPDC-Software kann die Daten vorläufig sammeln und an Microsoft-Dateien (z. B. Excel, Word usw.) übertragen. Wählen Sie den Exportdateityp und den Exportdateipfad und drücken Sie dann Ausführen, wie unten gezeigt.

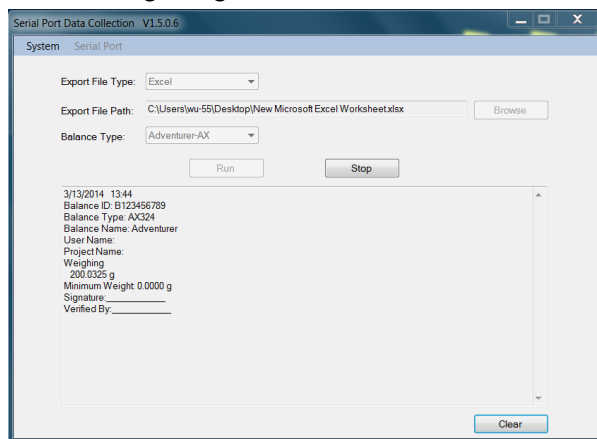

Systemanforderungen

- PC mit Windows 98®, Windows 98SE®, Windows ME®, Windows 2000®, Windows XP®, Windows 7® oder Windows 8® (32-bit).

Hinweis: Die neueste SPDC-Software unterstützt die englische und chinesische Sprache und kann von der Ohaus-Webseite heruntergeladen werden. Für weitere Informationen, siehe *SPDC-Datensammlung Bedienungsanleitung*.

7.2 Ausgabeformat

Die Ergebnisdaten und B/N/T-Daten werden im folgenden Format ausgegeben.

Feld:	Etikett ¹	Leerzeichen ²	Gewicht ³	Leerzeichen ²	Einheit ⁴	Leerzeichen	Stabilität ⁵	Leerzeichen	B/N ⁶	Leerzeichen	Abschl. Zeichen ⁷
Länge:		1	11	1	5	1	≤ 1	≤ 1	≤ 3	0	≤ 8

Hinweis:

1. Die Länge des Etikettfeldes ist nicht festgelegt.
2. Jedem Feld folgt ein einzelnes begrenzendes Leerzeichen (ASCII 32).
3. Das Gewichtsfeld besteht aus 11 rechtsbündig ausgerichteten Zeichen. Wenn der Wert negativ ist, befindet sich das Zeichen "-" unmittelbar links von der signifikantesten Stelle.
4. Das Einheitsfeld enthält die Abkürzung der Maßeinheit aus bis zu 5 Zeichen, rechtsbündig.
5. Das Stabilitätsfeld enthält das Zeichen "?", wenn der Gewichtswert nicht stabil ist. Das Stabilitätsfeld und das folgende Leerzeichenfeld werden weggelassen, wenn der Gewichtswert stabil ist.
6. Das B/N-Feld enthält die Netto- oder Bruttoanzeige. Für Bruttogewichte enthält das Feld "B". Für Nettogewichte enthält das Feld "N".
7. Das Abschlusszeichen-Feld enthält CRLF, vier CRLF oder Form Feed (ASCII 12), je nach Menüeinstellung bei der ZEILENVORSCHUB-Menüeinstellung.
8. Wenn "Nur numerisch" aktiviert ist, wird nur das Gewichtsfeld linksbündig gedruckt.

7.3 Ausdruckbeispiele

Beispiele für jede Anwendung werden mit allen **EINGESCHALTETEN** Elementen im **Druckmenü** angezeigt. Die Standardwerte für **Kopfzeilen** 1-5 werden ebenfalls gezeigt.

GRUNDWIEGUNG

Wiegung Anzahl

Wiegung Prozent

```

Header 1
Header 2
Header 3
07/19/2017 17:56:23
Balance ID: B234567890
Balance Name: PR4202/E
User Name:
Project Name:
Weigh
    0.10 g
Gross:    0.10 g G
Net:      0.10 g N
Tare:     0.00 g T

Signature: _____
Verified By: _____
    
```

```

Header 1
Header 2
Header 3
07/19/2017 17:57:19
Balance ID: B234567890
Balance Name: PR4202/E
User Name:
Project Name:
Count
Quantity: 4999 PCS
Gross:    49.99 g G
Net:      49.99 g N
Tare:     0.00 g T
APW: 0.010 g
Sample Size: 10 PCS

Signature: _____
Verified By: _____
    
```

```

Header 1
Header 2
Header 3
07/19/2017 17:57:19
Balance ID: B234567890
Balance Name: PR223/E
User Name:
Project Name:
Percent
Percentage: 10.156 % N
Gross:    23.361 g G
Net:      10.156 g N
Tare:     13.205 g T
Reference weight: 100.000 g

Signature: _____
Verified By: _____
    
```

Interne Kalibrierung

-OHAUS-
07/26/2017 05:16:53
Balance ID:
Balance Name: PR2202
User Name:
Project Name:
---Internal Calibration---
Calibration is done.
Difference weight: 0.00 g

Signature: _____
Verified By: _____

Spannenkalibrierung

-OHAUS-
07/26/2017 05:16:37
Balance ID:
Balance Name: PR2202
User Name:
Project Name:
---Span Calibration---
Calibration is done.
Reference weight: 2000.00 g
Actual weight: 2000.22 g
Difference weight: 0.22 g
Weight ID: _____

Signature: _____
Verified By: _____

Linearitätskalibrierung

-OHAUS-
07/26/2017 05:16:11
Balance ID:
Balance Name: PR2202
User Name:
Project Name:
---Linear Calibration---
Calibration is done.

Signature: _____
Verified By: _____

8. WARTUNG

8.1 Kalibrierung

Überprüfen Sie die Kalibrierung regelmäßig, indem Sie ein genaues Gewicht auf die Waage legen und das Ergebnis ablesen. Wenn eine Kalibrierung erforderlich ist, siehe Anweisungen in Abschnitt 5.2.

8.2 Reinigung



WARNUNG: Trennen Sie die Waage vor der Reinigung von der Stromversorgung. Stellen Sie sicher, dass keine Flüssigkeit in das Innere der Waage eindringt.



Reinigen Sie die Waage in regelmäßigen Abständen.

Die Gehäuseoberflächen können mit einem fusselfreien, leicht mit Wasser oder einem milden Reinigungsmittel angefeuchteten Tuch gereinigt werden.



Glasoberflächen können mit einem handelsüblichen Glasreiniger gereinigt werden.

Achtung: Verwenden Sie keine Lösungsmittel, scharfe Chemikalien, Ammoniak oder scheuernde Reinigungsmittel.

8.3 Fehlerbehebung

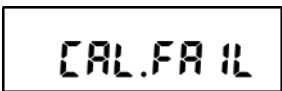
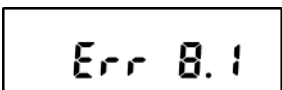
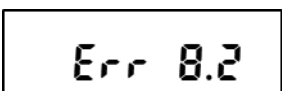
TABELLE 8-1. FEHLERBEHEBUNG

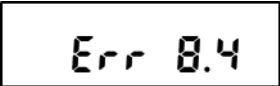
Symptom / Anzeige	Mögliche Ursache	Behebung
Die Menüeinstellungen lassen sich nicht ändern. 	Das Untermenü ist verriegelt.	Schalten Sie das Untermenü im Lockout-Menü frei.
Ein Untermenü wird ausgeblendet.	Dies ist ein zugelassenes Modell, bei dem die Sperrung bestimmter Untermenüs erforderlich ist.	Kalibrieren Sie die Waage, bevor Sie die gewerberechtliche Einstellung einstellen.
	Die Bedingungen sind nicht konstant.	Bringen Sie die Waage an einen besser geeigneten Ort und kalibrieren Sie sie erneut.
	Verwendung von falschen Kalibriermassen.	Verwenden Sie zum Kalibrieren nur Kalibriermassen, die den Kalibrierpunkten in der Spezifikationstabelle der Bedienungsanleitung entsprechen.
	Systemfehler	Falls der Fehler weiterhin besteht, kontaktieren Sie bitte den OHAUS-Service (www.ohaus.com - Mehr - Kontaktieren Sie uns)
	Beim Einschalten wird eine falsche Waagschale verwendet.	Verwenden Sie vor dem Einschalten eine original OHAUS-Waagschale.
	Die Last auf der Waagschale ist schwerer als die ursprüngliche Gewichtseinstellung.	Nehmen Sie die Last vor dem Einschalten von der Schale.
	Beim Einschalten wird eine falsche Waagschale verwendet.	Verwenden Sie vor dem Einschalten eine original OHAUS-Waagschale.
	Die Schale ist beim Einschalten nicht angebracht.	Bringen Sie die Waagschale vor dem Einschalten an.

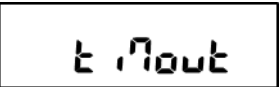
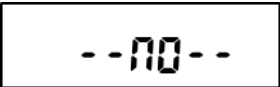
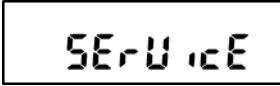
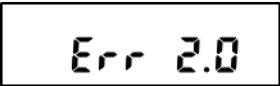
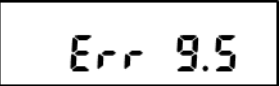
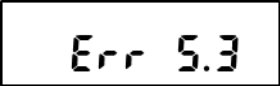
	Das Gewicht auf der Schale ist zu schwer.	Reduzieren Sie die Probemenge, bis das Gewicht innerhalb des Wägebereichs liegt.
	Die Schale ist nicht korrekt angebracht.	Bringen Sie die Waagschale korrekt an.
	Das durchschnittliche Stückgewicht der Probe ist zu gering (weniger als 0,1 d) für den Stückzahlmodus.	Berechnen Sie den APW-Wert neu. Sollte der Fehler andauern, verwenden Sie bitte eine andere Probe.
	Das Referenzgewicht auf der Waagschale ist zu gering (weniger als 100 d) für den Prozent-Wägemodus.	Legen Sie mehr Proben auf die Waagschale.
	Systemfehler	Kontaktieren Sie bitte den OHAUS-Service (www.ohaus.com - Mehr - Kontaktieren Sie uns)
	Die Bedingungen sind nicht konstant.	Bringen Sie die Waage an einen besser geeigneten Ort.
Wenn Sie Tara / Zero drücken 	Der Messwert liegt außerhalb des Nullbereichs. Der Nullbereich hängt von der Region ab.	Führen Sie den Nullabgleich gemäß den regionalen Anforderungen durch.
	Der Tarawert ist ein negativer Wert.	Drücken Sie Null anstatt auf Tara
	Systemfehler	Kontaktieren Sie bitte den OHAUS-Service (www.ohaus.com - Mehr - Kontaktieren Sie uns)
  	Systemfehler	Schalten Sie die Stromversorgung aus und starten Sie neu. Falls der Fehler weiterhin besteht, kontaktieren Sie bitte den OHAUS-Service (www.ohaus.com - Mehr - Kontaktieren Sie uns)

8.4 Service-Informationen

Wenn der Fehlerbehebungsabschnitt Ihr Problem nicht löst, wenden Sie sich an einen autorisierten Ohaus Service Agenten. Bitte besuchen Sie unsere Webseite www.ohaus.com, um das für Sie nächstgelegene Ohaus Büro zu finden.

9. TECHNISCHE DATEN

9.1 Spezifikationen

Umgebungsbedingungen

- Nur zur Innenanwendung
- Höhe: Bis zu 2000 m
- Angegebener Temperaturbereich: 10°C bis 30°C
- Luftfeuchtigkeit: maximale relative Luftfeuchtigkeit 80% für Temperaturen bis 30°C, linear abnehmend bis 50% relative Luftfeuchtigkeit bei 40°C
- Die Betriebsfähigkeit wird bei Umgebungstemperaturen zwischen 5 °C und 40 °C gewährleistet
- Netzversorgungsspannungsschwankungen: bis zu $\pm 10\%$ der Nennspannung
- Installationskategorie II
- Verschmutzungsgrad: 2
- Versorgungsspannung: 12V=0,5A

Materialien

- Unteres Gehäuse: Aluminiumdruckguss, Angestrichen + Kunststoff (HIPS)
- Oberes Gehäuse: Kunststoff (HIPS)
- Wägungsplattformen: Edelstahl
- Windschutz: Glas, Kunststoff (HIPS)
- Füße: Kunststoff (ABS)

Table 9-1. SPEZIFIKATIONEN

InCal-Modell		PR124	PR224	PR223	PR423	PR523
ExCal-Modell	PR64/E	PR124/E	PR224/E	PR223/E	PR423/E	PR523/E
Kapazität (g)	62	120	220	220	420	520
Lesbarkeit d (g)	0.0001	0.0001	0.0001	0.001	0.001	0.001
Wiederholbarkeit SD $\leq 5\%$ der Vollast (g)	0.00008	0.00008	0.00008	0.0008	0.0008	0.0008
Wiederholbarkeit SD, 5% von Vollast bis Full Range (g)	0.0001	0.0001	0.0001	0.001	0.001	0.001
Linearität, typisch (g)	± 0.00006	± 0.00006	± 0.00006	± 0.0006	± 0.0006	± 0.0006
Linearität (g)	± 0.0002	± 0.0002	± 0.0002	± 0.002	± 0.002	± 0.002
Stabilisierungszeit Typisch (s)	3	3	3	2	2	2
Empfindlichkeit Temperaturverschiebung (PPM / K)	± 3	± 3	± 3	± 8	± 3	± 3
Typisches Mindestgewicht USP (USP K=2, U=0,10%)	160 mg	160 mg	160 mg	1,6 g	1,6 g	1,6 g
Optimiertes Mindestgewicht (g) (USP, $u=0,10\%$, $k=2$) SRP $\leq 0,41d^*$	82 mg	82 mg	82 mg	0,82 g	0,82 g	0,82 g
Einheiten	Gramm, Milligramm, Karat, Unze, Feinunzen-Troy, Pennygewicht, Korn Taiwan Tael, Newton, Custom 1			Gramm, Milligramm, Kilogramm, Karat, Newton, Unze, Feinunzen-Troy, Pennygewicht, Korn, Pfund Taiwan Tael, Newton, Custom 1		
Anwendungen	Einfaches Wiegen; Stückzählung; Prozentwiegung					
Plattformgröße (Durchmesser)	3,5 in / 9 cm	3,5 in / 9 cm	3,5 in / 9 cm	4,7 in / 12 cm	4,7 in / 12 cm	4,7 in / 12 cm
Spannenkalibrierungspunkte (g)	50, 60	50, 100	100, 200	100, 200	200, 400	300, 500
Linearitätskalibrierungspunkte (g)	0, 30, 60	0, 50, 100	0, 100, 200	0, 100, 200	0, 200, 400	0, 250, 500
Tarabereich	Bis Kapazität durch Subtraktion					
Stromversorgung	Eingangsleistung: 100-240 V ~ 200 mA 50-60Hz 12-18VA Ausgangsleistung: 12 VDC 0,5A					
Dimensionen (zusammengebaut) (B x T x H) (mm)	201 x 317 x 303 mm 7.9 x 12.5 x 11.9 inch					
Kommunikation	RS232					
Betriebstemperaturbereich	Betriebsbedingungen für normale Laboranwendung: +10°C bis 30 °C (Betriebsfähigkeit garantiert von +5°C bis 40 °C)					
Lagertemperaturbereich	Luftfeuchtigkeit: maximale relative Luftfeuchtigkeit 80% für Temperaturen bis 30°C, linear abnehmend bis 50% relative Luftfeuchtigkeit bei 40°C					
Lagerbedingungen	-10°C bis 60°C, Luftfeuchtigkeit 10% bis 90%, ohne Kondensation					
Nettogewicht	10 lb / 4,5 kg					
Versandgewicht	15,4lb / 7 kg					
Versanddimensionen (B x T x H) (mm)	507 x 387 x 531					

*SRP bezieht sich auf die Standardabweichung für n Wiederholungswägungen ($n \geq 10$).

TABLE 9-2. SPEZIFIKATIONEN (Fortsetzung)

InCal-Modell	PR1602	PR2202	PR4202		PR4201	PR6201
ExCal-Modell	PR1602/E	PR2202/E	PR4202/E	PR2201/E	PR4201/E	PR6201/E
Kapazität (g)	1600	2200	4200	2200	4200	6200
Lesbarkeit d (g)	0.01	0.01	0.01	0.1	0.1	0.1
Wiederholbarkeit SD ≤5% der Vollast (g)	0.008	0.008	0.008	0.08	0.08	0.08
Wiederholbarkeit SD, 5% von Vollast bis Full Range (g)	0.01	0.01	0.01	0.1	0.1	0.1
Linearität, typisch (g)	±0.006	±0.006	±0.006	±0.06	±0.06	±0.06
Linearität (g)	±0.02	±0.02	±0.02	±0.2	±0.2	±0.2
Stabilisierungszeit Typisch (s)	1	1	1	1	1	1
Empfindlichkeit Temperaturverschiebung (PPM / K)	±6	±6	±3	±10	±10	±10
Typisches Mindestgewicht USP (USP K=2, U=0,10%)	16 g	16 g	16 g	160 g	160 g	160 g
Optimiertes Mindestgewicht (g) (USP, u=0,10%, k=2) SRP ≤ 0,41d*	8,2 g	8,2 g	8,2 g	82 g	82 g	82 g
Einheiten	Gramm, Kilogramm, Karat, Newton, Pfund, Unze, Unze Troja, Pfenniggewicht, Korn, Taiwan Tael, Custom 1					
Anwendungen	Einfaches Wiegen; Stückzählung; Prozentwiegung					
Plattformgröße (Durchmesser)	7,1 in / 18 cm	7.1 in / 18 cm	7.1 in / 18 cm	7.1 in / 18 cm	7.1 in / 18 cm	7.1 in / 18 cm
Spannenkalibrierungspunkte (g)	1000, 1500, 1600	1000, 2000	2000, 4000	1000, 2000	2000, 4000	5000, 6000
Linearitätskalibrierpunkte (g)	0, 800, 1600	0, 1000, 2000	0, 2000, 4000	0, 1000, 2000	0, 2000, 4000	0, 3000, 6000
Tarabereich	Bis Kapazität durch Subtraktion					
Stromversorgung	Eingangsleistung: 100-240 V ~ 200 mA 50-60Hz 12-18VA Ausgangsleistung: 12 VDC 0,5A					
Dimensionen (zusammengebaut) (B x T x H) (mm)	201 x 317 x 93 mm 7.9 x 12.5 x 3.7 inch					
Kommunikation	RS232					
Betriebstemperaturbereich	Betriebsbedingungen für normale Laboranwendung: +10°C bis 30 °C (Betriebsfähigkeit garantiert von +5°C bis 40 °C)					
Lagertemperaturbereich	Luftfeuchtigkeit: maximale relative Luftfeuchtigkeit 80% für Temperaturen bis 30°C, linear abnehmend bis 50% relative Luftfeuchtigkeit bei 40°C					
Lagerbedingungen	-10°C bis 60°C, Luftfeuchtigkeit 10% bis 90%, ohne Kondensation					
Nettogewicht	7.7 lb / 3,5 kg					
Versandgewicht	11 lb / 5 kg					
Versanddimensionen (B x T x H) (mm)	550 x 385 x 291					

*SRP bezieht sich auf die Standardabweichung für n Wiederholungswägungen (n ≥ 10).

TABLE 9-3. SPEZIFIKATIONEN (Fortsetzung)

InCal-Modell		PR523N
ExCal-Modell	PR323N/E	PR523N/E
Kapazität (g)	320	520
Lesbarkeit d (g)	0.001 oder 0.01	0.001 oder 0.01
Überprüfungsintervall e (g)	0.01	0.01
Klasse	II	II
Wiederholbarkeit SD $\leq 5\%$ der Volllast (g)	0.0008	0.0008
Wiederholbarkeit SD, 5% von Volllast bis Full Range (g)	0.001	0.001
Linearität, typisch (g)	± 0.0006	± 0.0006
Linearität (g)	± 0.002	± 0.002
Exzentrische Belastung	Nicht überschreiten des maximal zulässigen Fehlers für das Drittel der vollen Kapazität der Waage	
Stabilisierungszeit Typisch (s)	2	2
Empfindlichkeit Temperaturverschiebung (PPM / K)	± 3	± 3
Typisches Mindestgewicht USP (USP K=2, U=0,10%)	1.6 g	1.6 g
Optimiertes Mindestgewicht (g) (USP, u=0,10%, k=2) SRP $\leq 0,41d^*$	0.82 g	0.82 g
Einheiten	Gramm, Milligramm, Karat, Unze, Unze Troja, Gramm	
Anwendungen	Einfaches Wiegen; Stückzählung; Prozentwiegung	
Plattformgröße (Durchmesser)	4.7 in / 12 cm	4.7 in / 12 cm
Spannenkalibrierungspunkte (g)	200,300	300, 500
Linearitätskalibrierpunkte (g)	0, 150, 300	0, 250, 500
Tarabereich	Bis Kapazität durch Subtraktion	
Stromversorgung	Eingangsleistung: 100-240 V ~ 200 mA 50-60Hz 12-18VA Ausgangsleistung: 12 VDC 0,5A	
Dimensionen (zusammengebaut) (B x T x H) (mm)	201 x 317 x 303 mm 7.9 x 12.5 x 11.9 inch	
Kommunikation	RS232	
Betriebstemperaturbereich	Betriebsbedingungen für normale Laboranwendung: +10°C bis 30 °C (Betriebsfähigkeit garantiert von +5°C bis 40 °C)	
Lagertemperaturbereich	Luftfeuchtigkeit: maximale relative Luftfeuchtigkeit 80% für Temperaturen bis 30°C, linear abnehmend bis 50% relative Luftfeuchtigkeit bei 40°C	
Lagerbedingungen	-10°C bis 60°C, Luftfeuchtigkeit 10% bis 90%, ohne Kondensation	
Nettogewicht	10 lb / 4.5 kg	10 lb / 4.5 kg
Versandgewicht	15.4 lb / 7 kg	15.4 lb / 7 kg
Versanddimensionen (B x T x H) (mm)	507 x 387 x 531mm 20 x 15 x 21 inch	

*SRP bezieht sich auf die Standardabweichung für n Wiederholungswägungen ($n \geq 10$).

TABLE 9-4. SPEZIFIKATIONEN (Fortsetzung)

ExCal-Modell	PR322N/E	PR522N/E	PR822N/E	PR2202N/E	PR4202N/E	PR5202N/E
Kapazität (g)	320	520	820	2200	4200	5200
Lesbarkeit d (g)	0.01	0.01	0.1	0.01 oder 0.1	0.01 oder 0.1	0.01 oder 0.1
Überprüfungsintervall e (g)	0.01	0.01	0.1	0.1	0.1	0.1
Klasse	II	II	III	II	II	II
Wiederholbarkeit SD ≤5% der Volllast (g)	0.008	0.008	0.008	0.008	0.008	0.008
Wiederholbarkeit SD, 5% von Volllast bis Full Range (g)	0.01	0.01	0.01	0.01	0.01	0.01
Linearität, typisch (g)	±0.006	±0.006	±0.006	±0.006	±0.006	±0.006
Linearität (g)	±0.02	±0.02	±0.02	±0.02	±0.02	±0.02
Exzentrische Belastung	Nicht überschreiten des maximal zulässigen Fehlers für das Drittel der vollen Kapazität der Waage					
Stabilisierungszeit Typisch (s)	1	1	1	1	1	1
Empfindlichkeit Temperaturverschiebung (PPM / K)	±3	±3	±6	±6	±3	±3
Typisches Mindestgewicht USP (USP K=2, U=0,10%)	16g	16g	16g	16g	16g	16g
Optimiertes Mindestgewicht (g) (USP, u=0,10%, k=2) SRP ≤ 0,41d*	8.2g	8.2g	8.2g	8.2g	8.2g	8.2g
Einheiten	Gramm, Kilogramm, Karat, Pfund, Unze, Unze Troja, Korn					
Anwendungen	Einfaches Wiegen; Stückzählung; Prozentwiegung					
Plattformgröße (Durchmesser)	4.7 in / 12 cm			7.1 in / 18 cm		
Spannenkalibrierungspunkte (g)	200, 300	300,500	500,800	1000, 2000	2000, 4000	3000, 5000
Linearitätskalibrierpunkte (g)	0, 150, 300	0, 250, 500	0, 400, 800	0, 1000, 2000	0, 2000, 4000	0, 2500, 5000
Tarabereich	Bis Kapazität durch Subtraktion					
Stromversorgung	Eingangsleistung: 100-240 V ~ 200 mA 50-60Hz 12-18VA Ausgangsleistung: 12 VDC 0,5A					
Dimensionen (zusammengebaut) (B x T x H) (mm)	201 x 317 x 303 mm 7.9 x 12.5 x 11.9 inch			201 x 317 x 93 mm 7.9 x 12.5 x 3.7 inch		
Kommunikation	RS232					
Betriebstemperaturbereich	Betriebsbedingungen für normale Laboranwendung: +10°C bis 30 °C (Betriebsfähigkeit garantiert von +5°C bis 40 °C)					
Lagertemperaturbereich	Luftfeuchtigkeit: maximale relative Luftfeuchtigkeit 80% für Temperaturen bis 30°C, linear abnehmend bis 50% relative Luftfeuchtigkeit bei 40°C					
Lagerbedingungen	-10°C bis 60°C, Luftfeuchtigkeit 10% bis 90%, ohne Kondensation					
Nettogewicht	10 lb / 4.5 kg			7.7 lb / 3.5 kg		
Versandgewicht	15.4 lb / 7 kg			11 lb / 5 kg		
Versanddimensionen (B x T x H) (mm)	507 x 387 x 531 mm 20 x 15 x 21 inch			550 x 385 x 291 mm 22 x 15 x 12 inch		

*SRP bezieht sich auf die Standardabweichung für n Wiederholungswägungen (n ≥ 10).

TABLE 9-5. SPEZIFIKATIONEN (Fortsetzung)

ExCal-Modell	PR2201N/E	PR4201N/E	PR5201N/E	PR6201N/E
Kapazität (g)	2200	4200	5200	6200
Lesbarkeit d (g)	0.1	0.1	0.1	0.1 oder 1
Überprüfungsintervall e (g)	0.1	0.1	0.1	1
Klasse	II	II	II	III
Wiederholbarkeit SD $\leq 5\%$ der Volllast (g)	0.08	0.08	0.08	0.08
Wiederholbarkeit SD, 5% von Volllast bis Full Range (g)	0.1	0.1	0.1	0.1
Linearität, typisch (g)	± 0.06	± 0.06	± 0.06	± 0.06
Linearität (g)	± 0.2	± 0.2	± 0.2	± 0.2
Exzentrische Belastung	Nicht überschreiten des maximal zulässigen Fehlers für das Drittel der vollen Kapazität der Waage			
Stabilisierungszeit Typisch (s)	1	1	1	1
Empfindlichkeit Temperaturverschiebung (PPM / K)	± 10	± 10	± 3	± 10
Typisches Mindestgewicht USP (USP K=2, U=0,10%)	160g	160g	160g	160g
Optimiertes Mindestgewicht (g) (USP, $u=0,10\%$, $k=2$) SRP $\leq 0,41d^*$	82g	82g	82g	82g
Einheiten	Gramm, Kilogramm, Karat, Pfund, Unze, Unze Troja, Korn			
Anwendungen	Einfaches Wiegen; Stückzählung; Prozentwiegung			
Plattformgröße (Durchmesser)	7.1 in / 18 cm			
Spannenkalibrierungspunkte (g)	1000, 2000	2000, 4000	3000, 5000	5000, 6000
Linearitätskalibrierpunkte (g)	0, 1000, 2000	0, 2000, 4000	0, 2500, 5000	0, 3000, 6000
Tarabereich	Bis Kapazität durch Subtraktion			
Stromversorgung	Eingangsleistung: 100-240 V ~ 200 mA 50-60Hz 12-18VA Ausgangsleistung: 12 VDC 0,5A			
Dimensionen (zusammengebaut) (B x T x H) (mm)	201 x 317 x 93 mm 7.9 x 12.5 x 3.7 inch			
Kommunikation	RS232			
Betriebstemperaturbereich	Betriebsbedingungen für normale Laboranwendung: +10°C bis 30 °C (Betriebsfähigkeit garantiert von +5°C bis 40 °C)			
Lagertemperaturbereich	Luftfeuchtigkeit: maximale relative Luftfeuchtigkeit 80% für Temperaturen bis 30°C, linear abnehmend bis 50% relative Luftfeuchtigkeit bei 40°C			
Lagerbedingungen	-10°C bis 60°C, Luftfeuchtigkeit 10% bis 90%, ohne Kondensation			
Nettogewicht	7.7 lb / 3.5 kg			
Versandgewicht	11 lb / 5 kg			
Versanddimensionen (B x T x H) (mm)	550 x 385 x 291 mm 22 x 15 x 12 inch			

*SRP bezieht sich auf die Standardabweichung für n Wiederholungswägungen ($n \geq 10$).

Table 9-6 SPEZIFIKATIONEN (Fortsetzung)

InCal-Genehmigungsmodell	PR124M	PR224M	PR223M	PR323M	PR423M	PR523M
Kapazität (g)	120	220	220	320	420	520
Lesbarkeit d (g)	0.0001	0.0001	0.001	0.001	0.001	0.001
Überprüfungsintervall e (g)	0.001	0.001	0.01	0.01	0.01	0.01
Klasse	I	I	II	II	II	II
Wiederholbarkeit SD ≤5% der Vollast (g)	0.00008	0.00008	0.0008	0.0008	0.0008	0.0008
Wiederholbarkeit SD, 5% von Vollast bis Full Range (g)	0.0001	0.0001	0.001	0.001	0.001	0.001
Linearität, typisch (g)	± 0.00006	± 0.00006	±0.0006	±0.0006	±0.0006	±0.0006
Linearität (g)	± 0.0002	± 0.0002	±0.002	±0.002	±0.002	±0.002
Stabilisierungszeit Typisch (s)	3	3	2	2	2	2
Empfindlichkeit Temperaturdrift (PPM/K)	±3	±3	±3	±3	±3	±3
Typisches Mindestgewicht USP (USP K=2, U=0,10%)	160 mg	160 mg	1.6 g	1.6 g	1.6 g	1.6 g
Optimiertes Mindestgewicht (g) (USP, u=0,10%, k=2) SRP ≤ 0,41d*	82 mg	82 mg	0.82 g	0.82 g	0.82 g	0.82 g
Einheiten	g, mg, ct					
Anwendungen	Grundwiegungen, Teilezählungen, Prozentwiegungen, Dynamische Wiegungen, Dichtebestimmung					
Plattformgröße (Durchmesser, mm)	90	90	120	120	120	120
Spannenkalibrierpunkte (g)	50, 100	100, 200	100, 200	200, 300	200, 400	300, 500
Linearitätskalibrierpunkte (g)	0, 50, 100	0, 100, 200	0, 100, 200	0, 150, 300	0, 200, 400	0, 250, 500
Tarabereich	Bis Kapazität durch Subtraktion					
Stromversorgung	Eingangsstrom: 12 V DC 1A von AC / DC externe Stromversorgung Ausgangsstrom: 12 VDC 0,5A					
Maße wenn zusammengebaut (B x T x H) (mm)	209 x 321 x 309					
Kommunikation	RS232					
Betriebstemperaturbereich	Betriebsbedingungen für normale Laboranwendung: +10°C bis 30 °C (Betriebsfähigkeit garantiert von +5°C bis 40 °C)					
Lagertemperaturbereich	Luftfeuchtigkeit: maximale relative Luftfeuchtigkeit 80% für Temperaturen bis 30°C, linear abnehmend bis 50% relative Luftfeuchtigkeit bei 40°C					
Lagerbedingungen	-10°C bis 60°C, Luftfeuchtigkeit 10% bis 90%, ohne Kondensation					
Nettogewicht	10 lb / 4.5 kg					
Versandgewicht	15.4 lb / 7 kg					
Versanddimensionen (B x T x H) (mm)	507 x 387 x 531					

*SRP bezieht sich auf die Standardabweichung für n Wiederholungswägungen (n ≥ 10).

Table 9-7 SPEZIFIKATIONEN (Fortsetzung)

InCal-Genehmigungsmodell	PR1602M	PR2202M	PR4202M	PR5202M	PR4201M	PR6201M
Kapazität (g)	1600	2200	4200	5200	4200	6200
Lesbarkeit d (g)	0.01	0.01	0.01	0.01	0.1	0.1
Überprüfungsintervall e (g)	0.1	0.1	0.1	0.1	0.1	1
Klasse	II	II	II	II	II	II
Wiederholbarkeit SD $\leq 5\%$ der Volllast (g)	0.008	0.008	0.008	0.008	0.08	0.08
Wiederholbarkeit SD, 5% von Volllast bis Full Range (g)	0.01	0.01	0.01	0.01	0.1	0.1
Linearität, typisch (g)	± 0.006	± 0.006	± 0.006	± 0.006	± 0.06	± 0.06
Linearität (g)	± 0.02	± 0.02	± 0.02	± 0.02	± 0.2	± 0.2
Stabilisierungszeit Typisch (s)	1	1	1	1	1	1
Empfindlichkeit Temperaturdrift (PPM/K)	± 3	± 3	± 3	± 3	± 10	± 10
Typisches Mindestgewicht USP (USP K=2, U=0,10%)	16 g	16 g	16 g	16 g	160 g	160 g
Optimiertes Mindestgewicht (g) (USP, u=0,10%, k=2) SRP $\leq 0,41d^*$	8.2 g	8.2 g	8.2 g	8.2 g	82 g	82 g
Einheiten	g, kg, ct					
Anwendungen	Grundwiegungen, Teilezählungen, Prozentwiegungen, Dynamische Wiegungen, Dichtebestimmung					
Plattformgröße (Durchmesser, mm)	180	180	180	180	180	180
Spannenkalibrierpunkte (g)	1000, 1500, 1600	1000, 2000	2000, 4000	3000, 5000	2000, 4000	5000, 6000
Linearitätskalibrierpunkte (g)	0, 800, 1600	0, 1000, 2000	0, 2000, 4000	0, 2500, 5000	0, 2000, 4000	0, 3000, 6000
Tarabereich	Bis Kapazität durch Subtraktion					
Stromversorgung	Eingangsstrom: 12 V DC 1A von AC / DC externe Stromversorgung Ausgangsstrom: 12 VDC 0,5A					
Maße wenn zusammengebaut (B x T x H) (mm)	209 x 321 x 98					
Kommunikation	RS232					
Betriebstemperaturbereich	Betriebsbedingungen für normale Laboranwendung: +10°C bis 30 °C (Betriebsfähigkeit garantiert von +5°C bis 40 °C)					
Lagertemperaturbereich	Luftfeuchtigkeit: maximale relative Luftfeuchtigkeit 80% für Temperaturen bis 30°C, linear abnehmend bis 50% relative Luftfeuchtigkeit bei 40°C					
Lagerbedingungen	-10°C bis 60°C, Luftfeuchtigkeit 10% bis 90%, ohne Kondensation					
Nettogewicht	7.7 lb / 3.5 kg					
Versandgewicht	11 lb / 5 kg					
Versanddimensionen (B x T x H) (mm)	550 x 385 x 291					

*SRP bezieht sich auf die Standardabweichung für n Wiederholungswägungen ($n \geq 10$).

9.2 Zeichnungen und Dimensionen

Dimensionen wenn komplett zusammengebaut



Abbildung 9-1 0,001g / 0,0001g Modell



Abbildung 9-2 0,1 g / 0,01 g Modell-

9.3 Zubehörteile

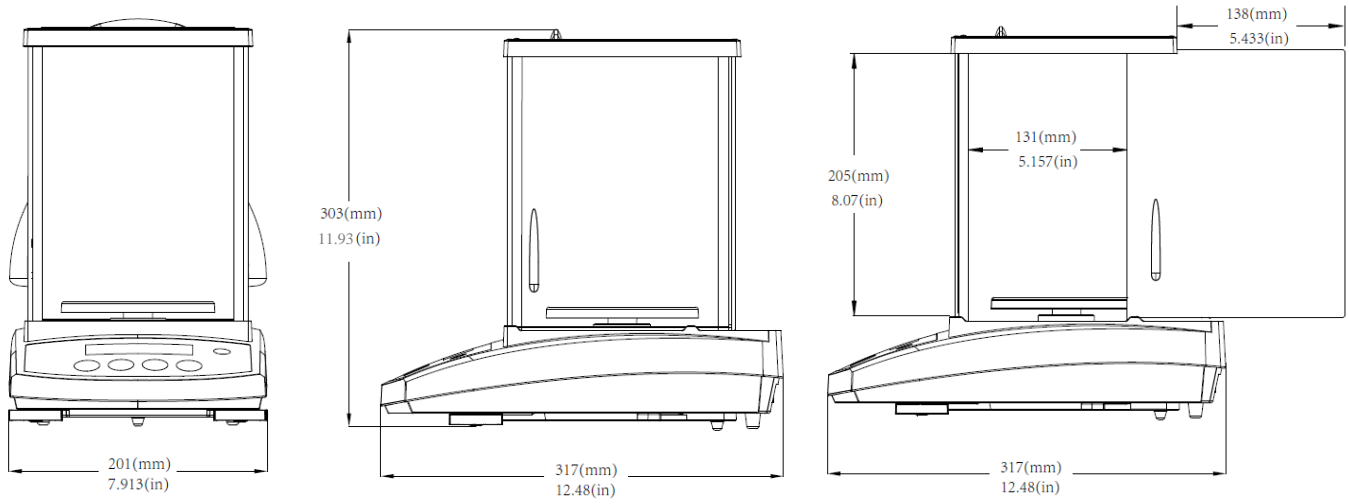
BESCHREIBUNG	TEILENUMMER
Hilfsdisplay AD7-RS	30472064
Sicherheitsgerät	80850043
RS232-Kabel (25-polig)	80500524
RS232-Kabel (9-polig)	80500525
Staubschutzabdeckung	30093334
Abdeckung bei Verwendung	30372547
Drucker SF40A	30064202 (EU); 30064203 (AM)
Netzteil für die Waage	46001724

9.4 Kommunikation

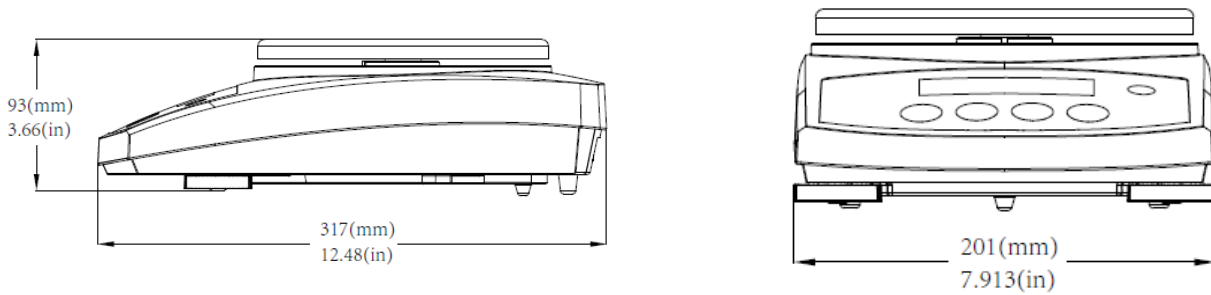
9.4.1 Schnittstellenbefehle

Befehle, die in der folgenden Tabelle aufgeführt sind, werden von der Waage erkannt.

Befehl	Funktion
IP	Direkter Ausdruck des angezeigten Gewichts (stabil oder instabil).
P	Druck des angezeigten Gewichts (stabil oder instabil).
CP	Fortlaufender Druck
SP	Druck bei Stabilität
SLP	Stellen Sie Auto-Druck auf Ein-Stabilität ein, lassen Sie das angezeigte Gewicht, das nicht Null ist, drucken.
SLZP	Stellen Sie Auto-Druck auf Bei Stabilität ein, so werden sowohl stabiles Nicht-Null-Gewicht als auch stabile Null-Ablesung drucken.
xP	Stellen Sie Auto-Druck auf Intervalldruck, x = Druckintervall (1-3600 Sek.), 0P deaktiviert das Intervall Drucken
0P	0P deaktiviert Intervalldruck, kontinuierlichen Druck oder Druck bei Stabilität
H	Druckkopfzeilen eingeben. Das Format lautet: H x "Kopfzeilenstring". Mit x = Zeilennummer 1 bis 3 kann "Kopfzeile" bis zu 24 alphanumerische Zeichen enthalten. Wenn kein String im Befehl vorhanden ist, liest "H x" die gespeicherte Kopfzeile x.
Z	Genauso wie dr Druck der Null-Taste
T	Genauso wie der Druck der Tara-Taste.
xT***	Legt einen voreingestellten Tarawert in der Display-Einheit fest. x voreingestellter Tarawert. Das Senden von 0T löscht Tara (wenn erlaubt)
PT	Druckt das abgespeicherte Taragewicht aus.
PM	Druckt den aktuellen Anwendungsmodus (Wiegemodus).
xM	Stellt den aktuellen Anwendungsmodus auf x. x hängt von den Anwendungen ab 1 - Wiegen 2 - Zählen 3 - Prozent
M	Scrollt zum nächsten aktivierten Modus
EIN (ON)	Schaltet die Waage aus dem Standby ein.
AUS (OFF)	Geht auf Standby.
C	Startet die Spannenkalibrierung
IC	Startet die interne Kalibrierung.
AC	Bricht die Kalibrierung ab.
PSN	Druckt die Seriennummer aus
PV	Druckversion: Druckname, Softwareversion und LFT Ein (wenn LFT aktiviert ist).
x#	Stellt Sie die APW-Zählung (x) in Gramm ein. (muss über ein gespeichertes APW verfügen)
P#	Druckt die Zähleranwendung APW aus.
x%	Stellt das Prozent-Referenzgewicht (x) in Gramm ein. (muss über ein gespeichertes Referenzgewicht verfügen)
P%	Druckt das Prozent-Referenzgewicht.
PZEIT	Druckt die aktuelle Uhrzeit

Befehl	Funktion
PDATUM	Druckt das aktuelle Datum
xZEIT	Stellt die Uhrzeit ein x-Format: hh:mm:ss
xDATUM	Stellt das Datum ein x-Format: mm/tt/jjjj
xS	0 = instabile Daten drucken, 1 = nur stabile drucken
xRL	Aktiviert oder deaktiviert die OK-Antwort auf nicht druckbare Befehle: x=0 zum Deaktivieren, x=1 zum Aktivieren.
xT	Tariert das Behältergewicht (x) in Gramm vor.

9.4.2 RS232 (DB9) Stiftverbindungen





Diagramm	Typ	Beschreibung
	Schnittstellentyp	Spannungsschnittstelle nach EIA RS-232C/DIN 66020 (CCITT V24/V.28)
	Max. Kabellänge	15 m
	Signalebene	Ausgang: +5 V ... +15 V (RL = 3 – 7kΩ) -5 V ... -15 V (RL = 3 - 7 kΩ) Eingang: +3 V ... +25 V -3 V ... -25 V
	Anschluss	Sub-D, 9-polig, Buchse
	Betriebsmodus	Vollduplex
	Übertragungsmodus	Bit-seriell, asynchron
	Übertragungscode	ASCII
	Baudraten	1200, 2400, 4800, 9600, 19200, 38400 (Firmware auswählbar)
	Bits/Parität	7 Bit/gerade, 7 Bit/ungerade, 7 Bit/keine, 8 Bit/keine (Firmware wählbar)
	Stopp-Bit	Stoppbit 1, 2
	Handschlag	Keiner, XON/XOFF, RTS/CTS (auswählbar)
	Ende der Linie	Nicht auswählbar

10. SOFTWARE UPDATES

Ohaus verbessert kontinuierlich seine Waagensoftware. Um die neueste Version zu erhalten, wenden Sie sich bitte an Ihren autorisierten Ohaus-Händler oder an die Ohaus Corporation.

11. Einhaltung

Die Einhaltung der folgenden Normen wird durch das entsprechende Zeichen auf dem Produkt angezeigt.

Kennzeichen	Standard
	Dieses Produkt entspricht den EU-Richtlinien 2014/30/EU (EMC), 2014/35/EU (LVD) und 2014/31/EU (NAWI). Die EU-Konformitätserklärung ist online unter www.ohaus.com/ce abrufbar.
	Dieses Produkt entspricht der EU-Richtlinie 2012/19/EU (WEEE). Bitte entsorgen Sie dieses Produkt gemäß den örtlichen Bestimmungen an der für Elektro- und Elektronikgeräte angegebenen Sammelstelle. Für Anweisungen zur Entsorgung in Europa, siehe www.ohaus.com/weee .
	Dieses Produkt entspricht den geltenden gesetzlichen Normen zur Beschränkung der Verwendung bestimmter gefährlicher Stoffe in Elektro- und Elektronikgeräten 2012, UK Electromagnetic Compatibility Regulations 2016, Electrical Equipment (Safety) Regulations 2016 und Non-Automatic Weighing Instruments Regulations 2016. Großbritannien Die Konformitätserklärung ist online unter www.ohaus.com/de-declarations verfügbar.
	EN 61326-1
	CAN/CSA-C22.2 No. 61010-1 UL Std. No. 61010-1

Wichtiger Hinweis für PX/PXP/PJX/PR....-M geprüfte Waagen in der EU und Großbritannien

Wenn das Gerät im Handel oder in einer gesetzlich kontrollierten Anwendung verwendet wird, muss es in Übereinstimmung mit den örtlichen Vorschriften für Gewichte und Maße aufgestellt, geprüft und versiegelt werden. Es liegt in der Verantwortung des Käufers, dafür zu sorgen, dass alle relevanten gesetzlichen Anforderungen erfüllt werden.

Die am Herstellungsort geprüften Waagen tragen folgende Merkmale und zusätzliche metrologische Kennzeichnung auf dem Typenschild.

  1259

  0126

Zweistufig geprüfte Waagen haben keine zusätzliche metrologische Kennzeichnung auf dem Typenschild. Die zweite Stufe der Konformitätsbewertung muss von den zuständigen Behörden für Gewichte und Maße durchgeführt werden.

Wenn nationale Vorschriften die Gültigkeitsdauer der Prüfung begrenzen, muss der Benutzer der Waage den Zeitraum der Nacheichung strikt einhalten und die Prüfbehörden informieren.

Da die Prüfungsanforderungen je nach Land variieren, sollte sich der Käufer an sein lokales Prüfbüro wenden, wenn die Anforderungen nicht bekannt sind.

ISED Canada Konformitätserklärung:

Dieses digitale Gerät der Klasse A entspricht der kanadischen ICES-003.

ISO 9001 Registrierung

Das Managementsystem für die Herstellung dieses Produkts ist nach ISO 9001 zertifiziert.

EINGESCHRÄNKTE GARANTIE

Für Ohaus-Produkte gilt eine Garantie für Material- und Verarbeitungsfehler ab dem Zeitpunkt der Lieferung für die Dauer der Garantiezeit. Während der Garantiezeit repariert Ohaus alle Komponenten, die sich als defekt erweisen, oder ersetzt diese kostenlos, sofern das Produkt frachtfrei an Ohaus zurückgesandt wird.

Diese Garantie gilt nicht, wenn das Produkt durch einen Unfall oder unsachgemäßen Gebrauch beschädigt wurde, radioaktiven oder korrosiven Materialien ausgesetzt wird, Fremdmaterial ins Innere des Produkts eindringt oder als das Ergebnis einer Wartung oder Modifizierung von Ohaus. Anstelle einer ordnungsgemäßen Rücksendung der Garantiekarte beginnt die Gewährleistungsfrist mit dem Datum des Versands an den Vertragshändler. Von der Ohaus Corporation wird keine andere ausdrückliche oder stillschweigende Garantie gewährt. Die Ohaus Corporation haftet nicht für Folgeschäden.

Da die Garantiebestimmungen von Bundesstaat zu Bundesstaat und von Land zu Land unterschiedlich sind, wenden Sie sich bitte an Ohaus oder Ihren lokalen Ohaus-Händler für weitere Details.

Sommario

1. INTRODUZIONE	IT-3
1.1 Descrizione	IT-3
1.2 Caratteristiche	IT-3
1.3 Definizione dei Segnali di Avvertimento e dei Simboli	IT-3
1.4 Precauzioni di Sicurezza	IT-3
2. INSTALLAZIONE	IT-4
2.1 Disimballaggio	IT-4
2.2 Selezionare la Posizione	IT-4
2.3 Livellamento	IT-4
2.4 Collegamento dell’Alimentazione Elettrica e Adattamento della Bilancia	IT-4
2.5 Collegamento dell’Interfaccia	IT-5
2.6 Taratura Iniziale	IT-5
3. FUNZIONAMENTO	IT-6
3.1 Visualizzazione del Display, Schermata Iniziale	IT-6
3.2 Funzioni Principali e Menu Principali	IT-7
3.3 Visualizzazione dei Pezzi e le loro Caratteristiche – Modelli Scudo Paravento	IT-7
3.4 Visualizzazione dei Pezzi e le loro Caratteristiche – Modelli Senza Scudo Paravento	IT-7
4. APPLICAZIONI	IT-8
4.1 Pesatura	IT-8
4.2 Conteggio dei Pezzi	IT-8
4.3 Pesatura Percento	IT-10
4.4 Caratteristiche Supplementari	IT-12
5. IMPOSTAZIONI MENU	IT-13
5.1 Menu Navigazione	IT-13
5.1.1 Cambiamento delle Impostazioni	IT-13
5.2 Taratura	IT-13
5.2.1 Taratura dei Sottomenu (modelli InCal)	IT-15
5.2.2 Taratura Interna (non applicabile ai modelli ExCal)	IT-15
5.2.3 Regolazione Cal (non applicabile ai modelli ExCal)	IT-15
5.2.4 Taratura di Portata	IT-15
5.2.5 Taratura di Linearità	IT-15
5.3 Impostazione della bilancia	IT-17
5.3.1 Livello del Filtro	IT-17
5.3.2 AZT (Tracciamento Automatico dello Zero)	IT-17
5.3.3 Auto-Taratura	IT-17
5.3.4 Graduazioni	IT-18
5.3.5 Formattazione della Data	IT-18
5.3.6 Impostazione della Data	IT-18
5.3.7 Formattazione dell’Orario	IT-18
5.3.8 Impostazione dell’Orario	IT-19
5.3.9 Luminosità	IT-19
5.3.10 Auto-Oscurazione	IT-19
5.3.11 Modalità Approvata	IT-19
5.4 Unità di pesatura	IT-21
5.5 Impostazione Interfaccia RS232	IT-21
5.5.1 Baud Rate	IT-21
5.5.2 Trasmissione	IT-22
5.5.3 Handshake	IT-22
5.6 Impostazioni di Stampa	IT-22
5.6.1 Solamente Stabile	IT-22
5.6.2 Solamente Numerici	IT-22
5.6.3 Intestazione Singola	IT-22
5.6.4 Auto-Stampa	IT-22
5.6.5 Intestazione	IT-22
5.6.6 Data e Orario	IT-22
5.6.7 ID della Bilancia	IT-22
5.6.8 Nome della Bilancia	IT-22

5.6.9	Nome dell'Utente	IT-22
5.6.10	Nome del Progetto	IT-22
5.6.11	Nome dell'Applicazione	IT-22
5.6.12	Risultato	IT-22
5.6.13	Lordo	IT-22
5.6.14	Netto	IT-22
5.6.15	Taratura	IT-22
5.6.16	Alimentazione della Linea	IT-22
5.7	GLP (Buone Pratiche di Laboratorio)	IT-25
5.7.1	Intestazione	IT-25
5.7.2	Nome della Bilancia	IT-25
5.7.3	Nome dell'Utente	IT-25
5.7.4	Nome del Progetto	IT-25
5.8	Ripristino Impostazioni di Fabbrica	IT-26
5.9	Bloccaggio	IT-26
6. (LFT) LEGALE PER IL COMMERCIO		IT-27
6.1	Impostazioni	IT-29
6.2	Verifica	IT-29
6.3	Sigillatura	IT-29
7. STAMPA		IT-29
7.1	Collegare, configurare and Provare la Stampante/Interfaccia del Computer	IT-29
7.2	Formato di Output	IT-29
7.3	Esempi di Stampa	IT-29
8. MANUTENZIONE		IT-32
8.1	Taratura	IT-32
8.2	Pulizia	IT-32
8.3	Risoluzione dei Problemi	IT-32
8.4	Informazione di Servizio	IT-33
9. DATI TECNICI		IT-34
9.1	Specifiche	IT-34
9.2	Disegni e Dimensioni	IT-42
9.3	Accessori	IT-43
9.4	Comunicazione	IT-43
9.4.1	Controlli Interfaccia	IT-43
9.4.2	Collegamenti Perno RS232 (DB9)	IT-44
10. AGGIORNAMENTI DEI SOFTWARE		IT-44
11. CONFORMITÀ		IT-45

1. INTRODUZIONE

1.1 Descrizione

La Bilancia PR è uno strumento di precisione che vi offrirà molti anni di servizio se tenuta con cura. Le Bilance PR sono disponibili con capacità da 62 grammi fino a 6.200 grammi.

1.2 Caratteristiche

Controlli di Funzionamento: display in controluce, con 3 applicazioni di pesatura e molte caratteristiche.



1.3 Definizione dei Segnali di Avvertimento e dei Simboli

Le note di sicurezza sono contrassegnate con parole di segnalazione e simboli di avvertimento. Questi mostrano problemi di sicurezza e avvertenze. Ignorare le note di sicurezza può causare lesioni personali, danni allo strumento, malfunzionamenti e risultati falsi.

AVVERTIMENTO	Per una situazione pericolosa con rischio medio, che potrebbe causare lesioni o morte se non evitata
CAUTELA	Per una situazione pericolosa a basso rischio, con conseguenti danni al dispositivo o alla proprietà o perdita di dati, o lesioni se non evitate.
Attenzione	Per informazioni importanti sul prodotto
Nota	Per informazioni utili sul prodotto

Simboli di Avvertimento



Pericolo Generale



Pericolo di Elettrocuzione



Corrente Alternata



Corrente Continua

1.4 Precauzioni di Sicurezza



CAUTELA Leggere tutti gli avvertimenti di sicurezza prima di installare, eseguire collegamenti o riparare quest'apparecchio. La mancata osservanza di queste avvertenze potrebbe causare lesioni personali e/o danni alle cose. Conservare tutte le istruzioni per riferimento futuro.

- Verificare che l'intervallo di tensione d'ingresso dell'adattatore CA e il tipo di spina siano compatibili con l'alimentazione di rete CA locale.
- Assicurarsi che il cavo di alimentazione non rappresenti un potenziale ostacolo o rischio d'inciampo.
- Non posizionare la bilancia in modo che sia difficile raggiungere il collegamento di alimentazione.
- La bilancia è solo per uso interno. Non usare l'apparecchio in ambienti pericolosi o instabili.
- Usare l'apparecchio solo nelle condizioni ambientali specificate nelle presenti istruzioni.
- Non far cadere i carichi sulla piastra della bilancia.
- Usare la bilancia solo in luoghi asciutti.
- Scollegare l'apparecchio dall'alimentazione elettrica quando si pulisce.
- Usare solo accessori e periferiche approvati.
- L'assistenza dovrebbe essere eseguita solo da personale autorizzato.

2. INSTALLAZIONE

2.1 Disimballaggio

Rimuovere con attenzione la Bilancia PR e ciascuno dei suoi componenti dal pacchetto. I componenti inclusi variano a seconda del modello della bilancia. Conservare l'imballaggio per garantire una sicura conservazione e trasporto. Si prega di leggere completamente il Manuale prima di installare e usare la Bilancia PR per evitare errori di funzionamento.

Componenti inclusi:

- Bilancia
- Adattatore di alimentazione + spina di attacco
- Piatto della bilancia in acciaio inossidabile
- Supporto del piatto della bilancia (solo per modello da 0,1 g / 0,01 g)
- Scheda di Garanzia

2.2 Selezionare la Posizione

Evitare fonti di calore, rapide variazioni di temperatura, correnti d'aria o eccessive vibrazioni. Lasciare sufficiente spazio.

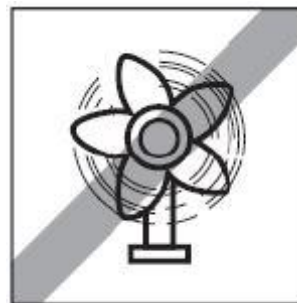
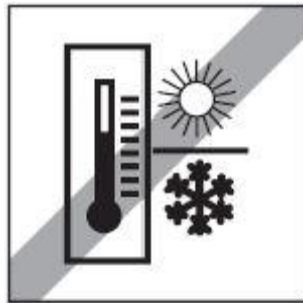

2.3 Livellamento

Assicurarsi che la bilancia sia a livello prima che venga utilizzata o dopo che la sua posizione sia cambiata.

La Bilancia PR ha una bolla di livello in una piccola finestra rotonda vicino al display.

Per livellare la bilancia, regolare i 2 piedini di livellamento fino a quando la bolla è centrata nel cerchio.

Per il livellamento, si prega di fare riferimento alla figura giusta.

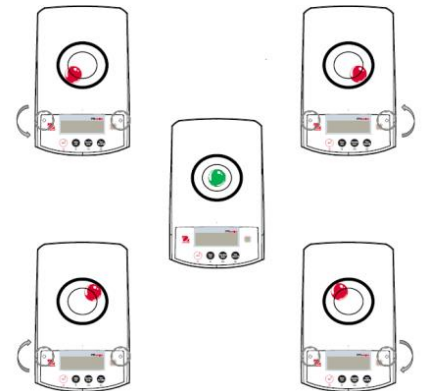

2.4 Collegamento dell'Alimentazione Elettrica e Adattamento della Bilancia

Collegare il connettore di output CC alla presa di alimentazione sul retro della bilancia. Quindi, collegare la spina dell'adattatore CA a una presa elettrica adeguata.

Adattamento

Si suggerisce di non usare la bilancia fino a quando non si è adattata all'ambiente per un certo periodo. Nel caso di bilancia con precisione superiore a 0,1 mg, il tempo di pre-adattamento deve essere di 1,5 ore; nel caso di bilancia con precisione di 1 mg, il tempo di adattamento deve essere superiore a 0,5 ore.

2.5 Collegamento dell'Interfaccia

La Bilancia PR ha una porta RS232.

Usare la porta RS-232 per collegarsi sia a un computer o a una stampante con un cavo seriale standard (diretto)

Interfacciare i collegamenti sul retro della bilancia.



RS232

RS232: È usato per collegare il PC o la Stampante

Nota: Vedi la sezione Stampante per Collegare, Configurare e Provare la Stampante/Interfaccia del Computer.

2.6 Taratura Iniziale

Quando la Bilancia PR viene installata per la prima volta, o quando viene spostata in un'altra posizione, deve essere calibrata per garantire risultati precisi della pesatura. Le Bilance PR sono classificate in due categorie: modelli InCal e modelli ExCal. I modelli InCal hanno un meccanismo di taratura incorporato che può tarare automaticamente la bilancia e non richiede l'uso di masse di taratura esterne. Se si dovesse preferire, i modelli InCal possono anche essere tarati manualmente con masse esterne. I modelli ExCal sono tarati con masse esterne. Assicurarsi di avere a disposizione le masse di taratura appropriate prima di iniziare la taratura.





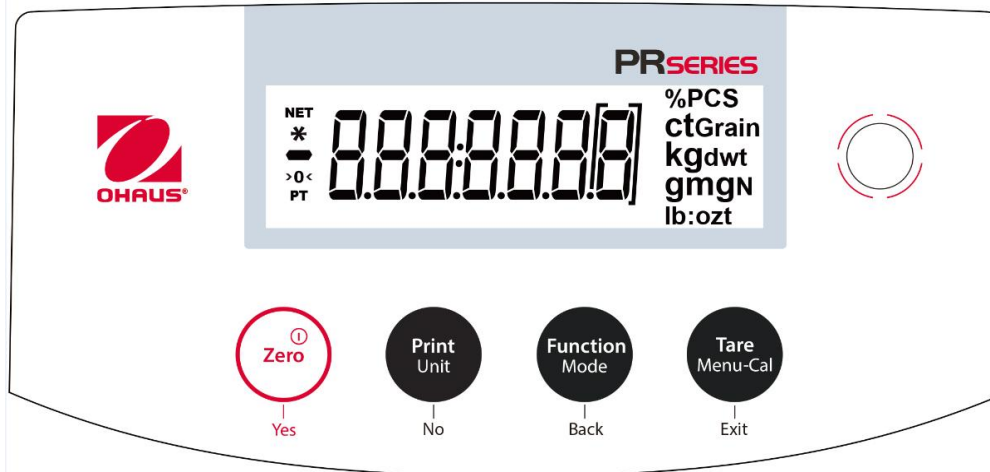

3. FUNZIONAMENTO

3.1 Visualizzazione del Display, Schermata Iniziale

CONTROLLI



CONTROLLO FUNZIONI

Pulsante	 Yes	 No	 Back	 Exit
Funzione Primaria (Premuta Breve) 	Acceso/Zero <ul style="list-style-type: none"> Se l'Indicatore è Spento, Accende l'Indicatore. Se l'Indicatore è Acceso, imposta lo zero. 	Stampa <ul style="list-style-type: none"> Invia il valore della corrente visualizzata all'interfaccia seriale. 	Funzione <ul style="list-style-type: none"> Funzionamento dipende sulla modalità dell'applicazione. 	Taratura <ul style="list-style-type: none"> Esegue il funzionamento della taratura.
Funzione Secondaria (Premere e Tieni Premuto) 	Spento <ul style="list-style-type: none"> Azzerare il valore della corrente. 	Unità <ul style="list-style-type: none"> Cambia pesatura delle unità. 	Modalità <ul style="list-style-type: none"> Cambia la modalità dell'applicazione. 	Chiamata-Menu <ul style="list-style-type: none"> Invia il menu principale. La taratura è il primo sottomenu. Visualizza il valore della Taratura preimpostata.
Funzione del Menu (Premuta Breve) 	Si <ul style="list-style-type: none"> Accetta l'impostazione della corrente (lampeggiante) sul display. 	No <ul style="list-style-type: none"> Respinge l'impostazione della corrente (lampeggiante) sul display. Incrementa un valore in Input. 	Ritorna <ul style="list-style-type: none"> Torna all'articolo del menu precedente. Diminuisce un valore in Input. 	Output <ul style="list-style-type: none"> Fa uscire il sottomenu immediatamente. Abbandona una taratura in progresso.

SCHERMO D'APPLICAZIONE PRINCIPALE



3.2 Funzioni Principali e Menu Principali

- Pesatura:** Prima premere **Zero** per impostare il display su zero. Porre un oggetto sulla piastra della bilancia. Il display indica il peso lordo.
- Taratura:** Senza carico sulla piastra della bilancia, premere **Zero** per azzerare il display. Porre un contenitore vuoto sulla piastra della bilancia e premi **Tarare**. Aggiungo oggetti nel contenitore e viene visualizzato il suo peso netto. Dopo aver rimosso il contenitore e gli oggetti, il carico verrà visualizzato come numero negativo. Premere **Tarare** per cancellare.
- Zero:** Premere **Zero** per azzerare la bilancia.

3.3 Visualizzazione dei Pezzi e le loro Caratteristiche – Modelli Scudo Paravento

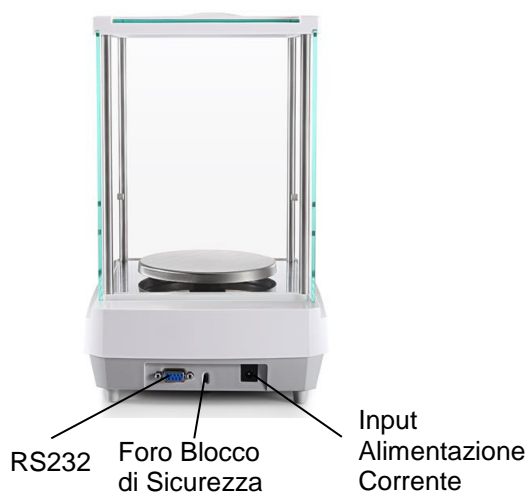

3.4 Visualizzazione dei Pezzi e le loro Caratteristiche – Modelli Senza Scudo Paravento



4. APPLICAZIONI



La Bilancia PR può funzionare in 3 modalità d'applicazione premendo a lungo il pulsante **Funzione/Modalità**.

4.1 Pesatura

Nota: Prima di usare qualsiasi applicazione, assicuratevi che la bilancia è a livello e tarata.

Usare quest'applicazione per determinare il peso degli oggetti nella selezionata unità di misura.

Pesatura

<ol style="list-style-type: none"> 1. Premere Tare o Zero se necessario per iniziare. 2. Premere e mantenere premuto il pulsante della Function / Mode per selezionare "WEIGH" (PESARE) (questa applicazione è l'impostazione predefinita). 	
<ol style="list-style-type: none"> 3. Porre oggetti sulla piastra della bilancia per visualizzare il peso. Una volta che la lettura è stabile, apparirà "*". 4. Il valore risultante viene visualizzato nell'unità di misurazione attiva. 	

Impostazioni degli Oggetti

Per visualizzare o regolare le impostazioni correnti

- **Unità di Pesatura:** Cambiare l'unità visualizzata. Vedi Sezione 5.4 per i processi dettagliati.
- **Filtro Livello:** Cambiare il Livello di Filtraggio. Vedi Sezione 5.3.2 per ulteriori informazioni.
- **Dati di Buone Pratiche di Laboratorio:** Vedi Sezione 5.7 per ulteriori informazioni.
- **Stampare le Impostazioni:** Cambiare le impostazioni di stampa. Vedi Sezione 7 per ulteriori informazioni.



4.2 Conteggio dei Pezzi

Nota: Prima di usare qualsiasi applicazione, assicurarsi che la bilancia sia a livello e calibrato. Il peso minimo del Pezzo non deve essere inferiore a 0,1 d. Nella modalità LFT, il peso minimo del pezzo è 3e, la dimensione minima del campione è 10.

Usa quest'applicazione per contare campioni di peso uniforme.

Conteggio dei Pezzi

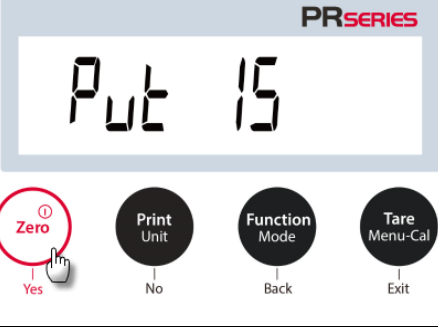
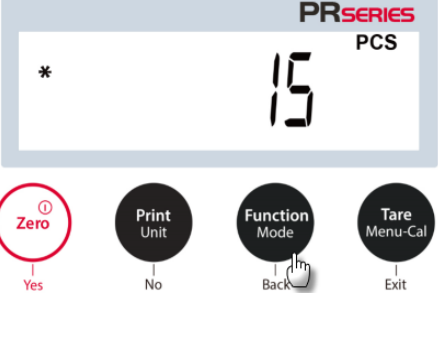
<ol style="list-style-type: none"> 1. Premere Tare o Zero se necessario per iniziare. 2. Premere e mantenere premuto il pulsante Function / Mode fino che "Count" (Conteggio) appare. 	
---	--

<p>3. Dopo conferma premendo “Yes” (SI), il messaggio “Clr.APWj” apparirà sullo schermo.</p>	 <p>The image shows the PR SERIES display with the text 'Clr.APWj'. Below the display are four buttons: Zero (circled in red with a hand cursor), Print Unit, Function Mode, and Tare Menu-Cal. Below each button is a label: Yes, No, Back, and Exit.</p>
<p>4. Premere “Yes” (Si), e il messaggio Put10 verrà visualizzato con il numero 10 (predefinito) lampeggiante. L'utente può premere “NO” (No) o “Yes” (Si) per aumentare o diminuire il valore. Ad esempio, per aumentare il valore a 15, premere “Yes” (Si). Quindi, “Put 15” (Porre 15) e 15 lampeggerà simultaneamente.</p>	 <p>The image shows the PR SERIES display with the text 'Put 15'. Below the display are four buttons: Zero (circled in red with a hand cursor), Print Unit, Function Mode, and Tare Menu-Cal. Below each button is a label: Yes, No, Back, and Exit.</p>
<p>5. Porre 15 campioni sulla piastra della bilancia. Premere il pulsante Function / Mode in modo che il peso dei 15 campioni venga utilizzato per stabilire il Peso Medio del Pezzo (APW). Il display mostrerà 15 pezzi.</p>	 <p>The image shows the PR SERIES display with the text '* 15 PCS'. Below the display are four buttons: Zero, Print Unit, Function Mode (with a hand cursor), and Tare Menu-Cal. Below each button is a label: Yes, No, Back, and Exit.</p>
<p>6. Rimuovere i 15 campioni dal piatto della bilancia e quindi porre altri campioni sulla piastra della bilancia. Il numero corrispondente di pezzi verrà visualizzato sullo schermo.</p>	 <p>The image shows the PR SERIES display with the text '* 20 PCS'. Below the display are four buttons: Zero, Print Unit, Function Mode, and Tare Menu-Cal. Below each button is a label: Yes, No, Back, and Exit.</p>
<p>7. Per visualizzare il peso totale o il numero di pezzi degli oggetti, premere il pulsante Function / Mode.</p>	 <p>The image shows the PR SERIES display with the text '* 400000 g'. Below the display are four buttons: Zero, Print Unit, Function Mode (with a hand cursor), and Tare Menu-Cal. Below each button is a label: Yes, No, Back, and Exit.</p>

Impostazioni degli Oggetti

Per visualizzare o regolare le impostazioni correnti.

Campione: Il numero del campione varia da 1 a 100. Il valore predefinito è 10.

Nota: Se l'APW (Peso Medio del Pezzo) delle ultime parti dell'operazione di conteggio deve essere mantenuto, l'utente può premere **No** quando il display mostra il messaggio **CLr.APW** (*clear the average piece weight* = cancellare il peso medio del pezzo). Porre altri oggetti sulla piastra della bilancia, e il numero corrispondente di pezzi verrà visualizzato sul display.

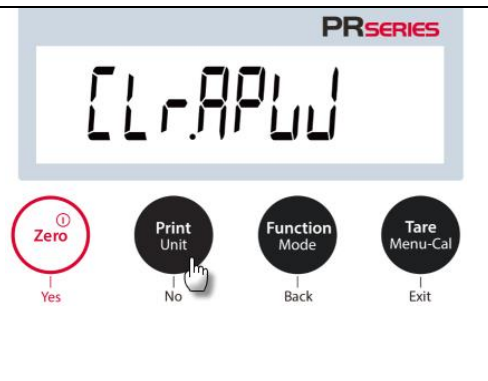
**Ottimizzazione dell'APW (Peso Medio del Pezzo):**

Migliorare la precisione del conteggio ricalcolando automaticamente il peso del pezzo man mano che i pezzi vengono aggiunti.

L'ottimizzazione APW (Peso Medio del Pezzo) avviene solamente quando il numero di pezzi aggiunti al piatto della bilancia è compreso tra uno e tre volte il numero già presente sulla piastra della bilancia.

Stampa impostazioni:

Modifica impostazione della stampa Vedi Sezione 7 per ulteriori informazioni.

**4.3 Pesatura Percento**

Nota: Prima di usare qualsiasi applicazione, assicuratevi che la bilancia è a livello e tarata.



Usare Pesatura percento per visualizzare il peso di un oggetto sottoposto a test come una percentuale di un campione di riferimento prestabilito.

Il peso di riferimento predefinito (o l'ultimo) viene visualizzato.

Pesatura Percento

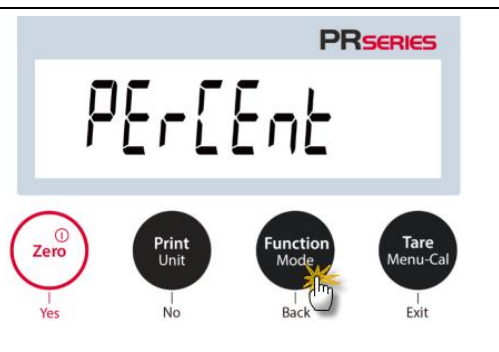
1. Premere e mantenere premuto il pulsante della **Function / Mode** finché **PERCENT** non appare.

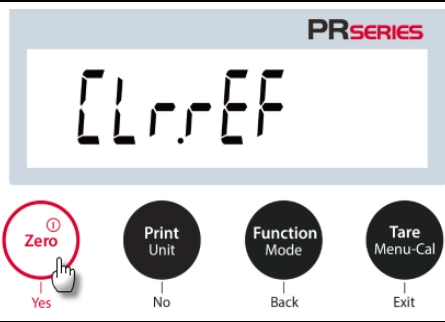
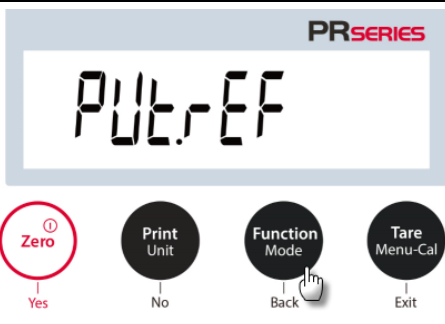

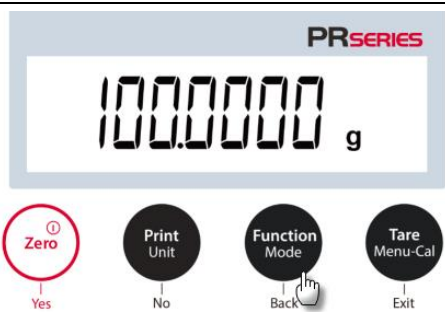
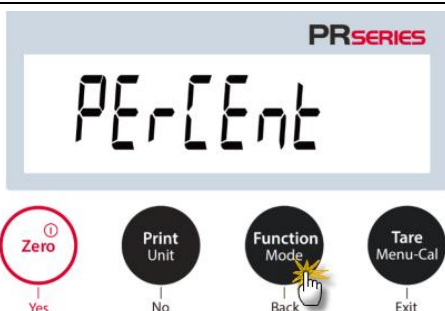
<p>2. Dopo conferma premendo “Yes” (Sì), il messaggio <i>CLr.rEF</i> (<i>clear the reference = cancellare il riferimento</i>) apparirà sullo schermo.</p>	
<p>3. Premere “Yes” (Sì), e <i>PUT.rEF</i> (<i>put the reference weight = porre il peso di riferimento</i>) sarà visualizzato.</p>	
<p>4. Porre il campione di riferimento sulla piastra della bilancia per visualizzare il peso. Quando la lettura è stabile, appare “*”.</p> <p>5. Premere il tasto Function / Mode in modo che il peso dei campioni di riferimento sia memorizzato. Il display mostrerà il 100%.</p>	
<p>6. Rimuovere il campione di riferimento e porre l'oggetto del test sulla piastra della bilancia. Il rapporto tra l'oggetto del test e il peso campione di riferimento viene visualizzato in percentuale.</p>	
<p>7. Per visualizzare il peso del campione di riferimento o la percentuale del peso dell'oggetto del test rispetto al peso del campione di riferimento, premere il pulsante Function / Mode.</p>	
<p>8. Per stabilire un nuovo peso campione di riferimento, premere a lungo il pulsante Function / Mode e ripetere i sopradescritti passaggi.</p>	

Impostazioni degli Oggetti

Nota: Se il peso di riferimento dell'ultima operazione della Pesatura Percentuale deve essere mantenuta, premere **No** quando il messaggio *CLr.rEF* (*Clear reference = Cancella riferimento*) viene visualizzato.

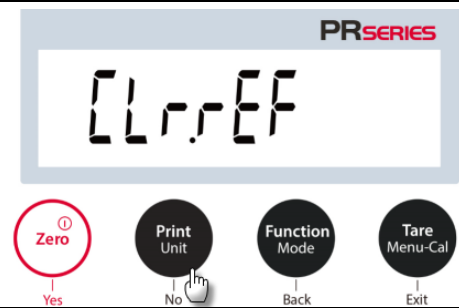
**Impostazione Stampa:**

Cambiare l'impostazione stampa. Vedi Sezione 7 per ulteriori informazioni.

4.4 Caratteristiche Supplementari**Pesatura Sotto la bilancia**

Nota: Assicurarsi che la bilancia è a livelle e tarata.

La Bilancia PR è provvista di un gancio per pesatura sotto per pesare sotto la bilancia (come mostrato nella figura di seguito).

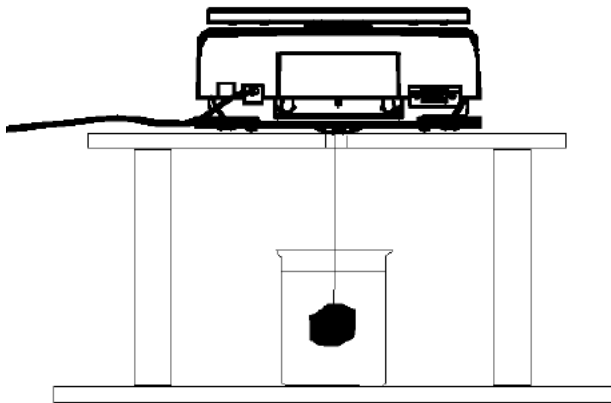

Prima di rovesciare la bilancia, rimuovere il piatto della bilancia e gli elementi del paravento (se presenti) per evitare danneggiamenti. Non porre la bilancia sul cono di supporto del piatto della bilancia, o sui perni della cella di carico.

Per usare questa funzione, rimuovere l'alimentazione elettrica dalla bilancia, quindi rimuovere la copertura protettiva per l'apertura della pesatura sotto la bilancia.

Accendere la bilancia e quindi usare uno spago o un cavetto per attaccare gli oggetti da pesare.



Copertura
protettiva per
pesatura sotto
la bilancia



Gancio pesatura
sotto la bilancia

5. IMPOSTAZIONI MENU

5.1 Menu Navigazione

Calibration	Setup	Unit	RS232	Print	GLP	Reset	Lock
InCal	Filter Level	Gram	Baud Rate	Stable Only	Header 1	Reset All	Calibration
Cal Adjust	AZT	Kilogram	Parity	Numeric Only	Header 2		Setup
Span Cal	Auto Tare	Milligram	Handshake	Single Header	Header 3		RS232
Linearity Cal	Graduations	Carat		Auto Print	Balance Name		Print
	Date Format	Pound		Header	User Name		GLP
	Date Setting	Ounce		Date and Time	Project Name		Reset
	Time Format	Ounce Troy		Balance ID			
	Time Setting	Penny Weight *		Balance Name			
	Brightness	Newton		User Name			
	Auto Dim	Grain		Project Name			
	LFT	TW Tael		Application Name			
		Custom 1		Result			
				Gross Weight			
			Net Weight				
			Tare Weight				
			Signature Line				
			Line Feed				

* Penny weight is not available for NTEP model.

5.1.1 Cambiamento delle Impostazioni

Per cambiare un'impostazione menu, navigare a questa impostazione utilizzando i seguenti passi:

Accedere nel Menu

Premere a lungo il pulsante Menu per accedere nel **Menu**.

Seleziona il Sottomenu

Premere **No** per spostarsi tra i sottomenu, e premere "**YES**" (Sì) per accedere al sottomenu.

Selezionare l'Oggetto del Menu

Premere **No** per scorrere gli Oggetti del Menu e premere "**YES**" (Sì) per accedere gli Oggetti visualizzati dal Menu.

5.2 Taratura

La Bilancia PR offre una scelta di tre metodi di taratura: Taratura Interna (solamente per i modelli InCal), Taratura Portata e Taratura Linearità. **Attenzione:** non disturbare la bilancia durante la taratura.

5.2.1 Taratura dei Sottomenu (modelli InCal)

Nota: solamente i modelli ExCal hanno Taratura Portata e Taratura Linearità.

5.2.2 Taratura Interna (non applicabile ai modelli ExCal)

La taratura si ottiene con la massa di taratura interna. La Taratura Interna può essere eseguita in qualsiasi momento, a condizione che la bilancia si sia riscaldata fino alla temperatura di funzionamento e sia a livello.

Con la bilancia Accesa e senza carico sulla piastra della bilancia si può eseguire la taratura interna. premere il tasto **Tare / Menu-Cal** per accedere all'impostazione di calibrazione interna.

In alternativa, premere il pulsante **Taratura/Menu-Cal** e selezionare InCal per iniziare la taratura interna.

Impostare la funzionalità di taratura Interna.		InCAL Taratura Interna
On = Acceso Off = Spento. Incal = Avviare la taratura interna		
ON Acceso	OFF Spento	InCAL Taratura Interna

Lo schermo mostra lo stato e premere qualsiasi pulsante per tornare alla schermata precedente..

5.2.3 Regolazione Cal (non applicabile ai modelli ExCal)

Usare questo metodo di taratura per sintonizzare l'effetto della Taratura Interna. La Regolazione della Taratura può essere usata per regolare il risultato della Taratura Interna di ± 100 divisioni.

Nota: Prima di eseguire una regolazione della taratura, eseguire una Taratura Interna. Per verificare se è necessario una regolazione, porre una massa del test uguale al **valore di taratura di portata** sulla piastra della bilancia e notare la differenza (in divisioni) tra il valore di massa nominale e la lettura effettiva della bilancia. Se la differenza è entro +/- la divisione, non è necessaria la regolazione della taratura. Se la differenza supera +/- 1 la divisione, si raccomanda la regolazione della taratura.

Esempio:

Lettura del peso previsto:	200.000 (valore massa del test)
Lettura effettiva del peso:	200.014
Differenza in grammi:	- 0,014
Differenza nella divisione:	- 14 (valore regolazione InCal)

Per eseguire una Regolazione della Taratura, selezionare una Regolazione InCal dall'elenco del Menu Taratura; inserire il valore (divisioni sia positivo che negativo) per far corrispondere la differenza annotata in precedenza nella procedura.







Ricalibrare usando la Taratura Interna. Dopo la taratura, porre la massa del test sulla piastra della bilancia e verificare che il valore di massa ora corrisponda al valore visualizzato. In caso contrario, ripetere la procedura fino a quando la lettura della Taratura Interna concorda con la massa del test.

Una volta completato, la bilancia memorizza il valore di Regolazione e il display torna all'applicazione corrente.

5.2.4 Taratura di Portata

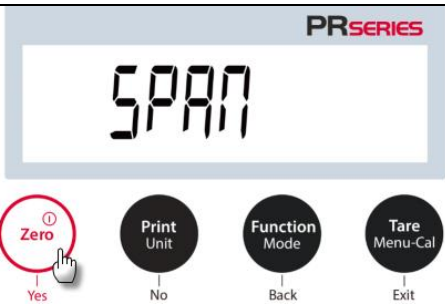
La Taratura di Portata utilizza due punti di taratura, uno a **carico zero** e l'altro a **pieno carico specificato** (portata). Per informazioni dettagliate sulla massa di taratura, fare riferimento alle tabelle delle Specifiche nei "Punti Taratura di Portata", SPECIFICHE, Sezione 9. Con la bilancia Accesa e senza carico sulla piastra della bilancia, è possibile eseguire Taratura di Portata. Ulteriori valori di taratura da usare sono mostrati sul display. La migliore precisione viene raggiunta utilizzando la massa più vicina al valore della portata completa.







Passi per taratura di portata.

<p>1. Premere e tenere premuto il pulsante Tara/Menu-Cal, e verrà visualizzato il menu Taratura..</p>	
<p>2. Premere “YES” (Si) per accedere al Menu Taratura.</p>	
<p>3. Per cambiare la modalità di taratura, premere No finché non viene visualizzato “SPAN” “span calibration” (TARATURA DI PORTATA).</p>	
<p>4. il valore delle masse di taratura verrà mostrato sullo schermo. dopo che il display mostra 200.0000 g, si prega di porre il peso(i) di 200 g sulla piastra della bilancia per la taratura. per passare al punto di taratura di metà a piena capacità (ad esempio 100 g), premere il pulsante funzione/modalità. Se viene visualizzato 0,0000 g, rimuovere la massa.</p>	
<p>5. una volta completata correttamente la taratura di portata, verrà visualizzato “cal.done” (taratura eseguita). premere qualsiasi pulsante per tornare alla schermata precedente.</p>	
<p>6. Rimuovere il peso e la lettura sarà azzerata.</p>	

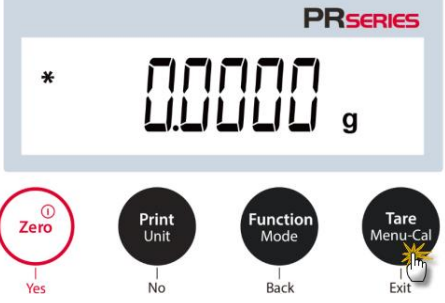
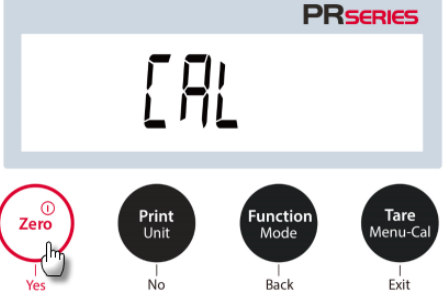
5.2.5 Taratura di Linearità

La taratura di linearità utilizza tre punti di taratura, uno a carico zero e gli altri a carichi specificati. Senza carico sulla bilancia, premere Taratura di Linearità per iniziare il processo. La bilancia acquisisce il punto zero e quindi richiede il peso successivo. Continuare a seguire le istruzioni sul display fino al completamento della taratura.

Passi per taratura di linearità

<p>1. Premere e mantenere premuto il pulsante Tara/Menu-Cal, e verrà visualizzato il Menu Taratura.</p>	 <p>The display shows "PR SERIES" at the top, a star symbol on the left, and "0.00000 g" in the center. Below the display are four buttons: "Zero" (circled in red), "Print Unit", "Function Mode", and "Tare Menu-Cal". A hand icon is pointing to the "Tare Menu-Cal" button.</p>
<p>2. Premere "YES" (Sì) per accedere al menu Taratura.</p>	 <p>The display shows "PR SERIES" at the top and "CAL" in the center. Below the display are four buttons: "Zero" (circled in red), "Print Unit", "Function Mode", and "Tare Menu-Cal". A hand icon is pointing to the "Zero" button.</p>
<p>3. Per cambiare la modalità di taratura, premere No fino a visualizzare "LineRr (span calibration)" (TARATURA DI PORTATA).</p>	 <p>The display shows "PR SERIES" at the top and "LineRr" in the center. Below the display are four buttons: "Zero" (circled in red), "Print Unit", "Function Mode", and "Tare Menu-Cal". A hand icon is pointing to the "Zero" button.</p>
<p>4. Il valore delle masse di taratura verrà visualizzato sul display. Dopo che il display mostra 100,0000 g porre un peso(i) di 100 g sulla piastra della bilancia per la taratura.</p>	 <p>The display shows "PR SERIES" at the top and "100.00000 g" in the center.</p>
<p>5. Rimuovere il peso di 100 g dal piatto della bilancia. Dopo un po', verranno visualizzati 200,0000 g sullo schermo. Si prega di porre un peso(i) di 200 g sulla piastra della bilancia.</p>	 <p>The display shows "PR SERIES" at the top and "200.00000 g" in the center.</p>
<p>6. Una volta completata correttamente la taratura della linearità, verrà visualizzato "CAL.Done" (Taratura eseguita). Premere qualsiasi pulsante per tornare alla schermata precedente.</p>	 <p>The display shows "PR SERIES" at the top and "CALdone" in the center.</p>
<p>7. Rimuovere il peso e la lettura sarà impostata sullo Zero.</p>	 <p>The display shows "PR SERIES" at the top and "0.00000 g" in the center.</p>

5.3 Impostazione della bilancia

Inviare il presente sottomenu per personalizzare la funzionalità della bilancia.

Nota: Le impostazioni predefinite dalla fabbrica sono mostrate di seguito in **grassetto**.

5.3.1 Livello del Filtro

Imposta la quantità di filtro del segnale.

F I L T E R

Basso = tempo di stabilizzazione più rapido con minore stabilità.

Medio = tempo di stabilizzazione normale con stabilità normale.

Alto = tempo di stabilizzazione più lento con maggiore stabilità

Low

Basso

MED

Medio

HIGH

Alto

5.3.2 AZT (Tracciamento Automatico dello Zero)

Impostare la funzionalità del tracciamento automatico dello zero

A Z T

Tracciamento Auto-Zero

Spento = disattivato.

0.5d = il display mantiene lo zero fino alla deriva di 0.5 gradi per secondo.

1d = il display mantiene lo zero fino alla deriva di 1 grado per secondo.

3d = il display mantiene lo zero fino alla deriva di 3 gradi per secondo.

0.5 d

0.5 d

1 d

1 d

3 d

3 d

5.3.3 Auto-Taratura

Impostare la taratura automatica.

Quando la taratura automatica è impostata su Acceso, il primo oggetto posto sulla piastra della bilancia sarà ritenuto come un contenitore e tarato automaticamente.

Spento = disattivato.

Acceso = attivato.

A.T.A.-E

Auto-Taratura

OFF

Spento

ON

Acceso

5.3.4 Graduazioni

Impostare la leggibilità visualizzata della bilancia.

1 Divisione = leggibilità standard.

10 Divisioni = la leggibilità viene aumentata da un fattore di 10.

Per esempio, se la leggibilità standard è 0,01 g, selezionando 10 Divisioni avranno come risultato una lettura di 0,1 g.

GrAd	1 d	10 d
Graduazione	1 Divisione	10 Divisioni

5.3.5 Formattazione della Data

Impostare la formattazione dell'attuale data.

Formattazione Data:

AA/MM/GG

MM/GG/AA

GG/MM/AA

d.ForMte	MMDDYY
Formattazione Data	MM/DD/YYYY
dMYY	YYMMDD
DD/MM/YYYY	YYYY/MM/DD

5.3.6 Impostazione della Data

Impostare l'attuale data nella formattazione della desiderata data.

Per impostare l'attuale data, premere **No** o **"Yes"** (Sì) per aumentare o diminuire il valore.

Per esempio, se la data attuale è 22 giugno 2017,

MM/GG/AA: 06.22.17

GG/MM/AA: 22.06.17

AA/MM/GG: 17.06.22

dAtE
Data
06.22.17

5.3.7 Formattazione dell'Orario

Impostare la formattazione dell'Orario.

Formattazione Orario:

24H

12H

t.ForMte	24 hr	12 hr
Formattazione Orario	24hr	12hr

5.3.8 Impostazione dell'Orario

Impostare l'attuale orario nella formattazione del desiderato orario.	6.17E
Per impostare l'attuale orario, premere No o "Yes" (Sì) per aumentare o diminuire il valore.	08.00.00

5.3.9 Luminosità

Impostare la luminosità del display.	br 9ht Luminosità	med
Medio Alto Basso	HIGH Alto	Low Basso

5.3.10 Auto-Oscurazione

Impostare se la bilancia spegne automaticamente la retroilluminazione del display.	Aut.d 17	
Off = disattivato. 10 minuti = si oscura se per 10 minuti è senza movimento. 20 minuti = si oscura se per 20 minuti è senza movimento. 30 minuti = si oscura se per 30 minuti è senza movimento.		
10 17 t 10 min	20 17 t 20 min	30 17 t 30 min

5.3.11 Modalità Approvata

Usare il presente menu per impostare il Legale per lo stato Commerciale. OFF = funzionamento standard. ON = il funzionamento è conforme ai regolamenti della Metrologia Legale.	LFE
--	-----

Per i modelli PRxxxN:

Usare il presente menu per impostare il Legale per lo stato Commerciale. OFF = funzionamento standard. ON 1d = il funzionamento è conforme ai regolamenti della Metrologia Legale, e=1d. ON 10d = il funzionamento è conforme ai regolamenti della Metrologia Legale, e=10d.	LFE
--	-----

Nota: Quando la Modalità Approvata è impostata su Acceso, le impostazioni del menu sono influenzate come segue:

Taratura Menu:

- Per i modelli InCal, solamente la Taratura Interna è disponibile. Tutte le altre funzioni sono nascoste.

Impostazione Menu Bilancia:

- Nell'attuale situazione il Livello del Filtro è bloccato.
- Il Tracciamento Automatico dello Zero è limitato a 0,5 Divisioni e Spento. L'impostazione selezionata è bloccata.
- L'Auto-Taratura è bloccata all'attuale impostazione.
- Le graduazioni sono forzate su 1 Divisione e la voce del menu è nascosta.

Menu di Comunicazione (Comunicazione --> Stampa Impostazioni --> Stampa Output):

- Solamente il Peso Stabile è bloccato su Acceso.
- Solamente il Valore Numerico è bloccato su Spento.

Menu di Comunicazione (Comunicazione --> Stampa Impostazioni-> Stampa Automatica):

- Le selezioni della modalità di stampa automatica sono limitate a Spento, a Stabilità e ad Intervallo. Continuo non è disponibile.

Menu di blocco:

- Il menu è nascosto

5.4 Unità di pesatura

Inviare in questo sottomenu per attivare le unità di misura desiderate.



Le Bilance PR forniscono una scelta di 12 unità, che sono tutte su Acceso per impostazione predefinita.

Nota: A causa delle leggi nazionali, la bilancia potrebbe non includere alcune delle unità di misura elencate di seguito.

Modello NTEP: Il menu Unit (Unità) viene utilizzato per attivare, disattivare una determinata unità. (SET ON, SET OFF).

Unità	Display
Grammo	g
Kilogrammo	kg
Milligrammo	mg
Carato	ct
Libbra	lb
Oncia	oz
Oncia Troy	ozt
Unità di peso troy	dwt
Newton	N
TW Tael	t
Custom 1	C
Grano	GN

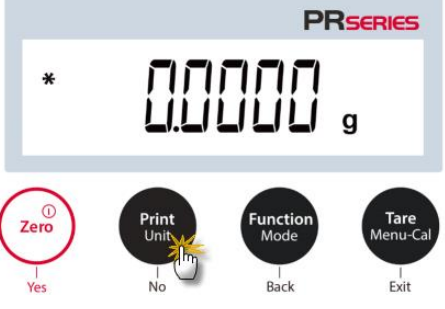
Cambio Unità di Pesatura

<p>1. Premere e tenere premuto il pulsante Stampa/Unità finché viene visualizzato il <i>Menu Unità</i>.</p>	 <p>The image shows the PR SERIES scale display with '0.00000 g' and a '*' symbol. Below the display are four buttons: 'Zero' (circled in red), 'Print Unit', 'Function Mode', and 'Tare Menu-Cal'. A mouse cursor is pointing at the 'Print Unit' button.</p>
<p>2. L'unità predefinita è il grammo (g). Per cambiare l'unità, premere No per passare all'unità successiva.</p>	 <p>The image shows the PR SERIES scale display with 'Unit g'. Below the display are four buttons: 'Zero' (circled in red), 'Print Unit', 'Function Mode', and 'Tare Menu-Cal'. A mouse cursor is pointing at the 'Print Unit' button.</p>
<p>3. Press “Yes” (Si) per impostare l'unità visionata all'unità di pesatura</p>	 <p>The image shows the PR SERIES scale display with 'Unit mg'. Below the display are four buttons: 'Zero' (circled in red), 'Print Unit', 'Function Mode', and 'Tare Menu-Cal'. A mouse cursor is pointing at the 'Zero' button.</p>

5.5 Impostazione Interfaccia RS232

<p>Inviare in questo sottomenu per personalizzare le impostazioni standard RS232. I dati possono essere emessi sia alla Stampante o a un PC.</p>	 <p>The image shows the PR SERIES scale display with 'r5232'.</p>
--	---

5.5.1 Baud Rate

<p>Impostare i baud rate (bits per secondo).</p>	 <p>The image shows the PR SERIES scale display with 'bAud'.</p>
<p>1.200 = 1.200 bps 2.400 = 2.400 bps 4.800 = 4.800 bps 9.600 = 9.600 bps 19.200 = 19.200 bps 38.400 = 38.400 bps</p>	

5.5.2 Trasmissione

Impostare i dati bit, stop bit, e parità.

8-N-1 = 8 dati bit, no parità, stop bit 1

8-N-2 = 8 dati bit, no parità, stop bit 2

7-E-1 = 7 dati bit, no parità, stop bit 1

7-E-2 = 7 dati bit, parità pari, stop bit 2

7-N-1 = 7 dati bit, no parità, stop bit 1

7-N-2 = 7 dati bit, no parità, stop bit 2

7-O-1 = 7 dati bit, parità dispari, stop bit 1

7-O-2 = 7 dati bit, parità dispari, stop bit 2

PARITY

Parità

8-N-1

8 dati bit, stop bit 1

5.5.3 Handshake

Impostare il metodo controllo flusso.

NESSUNO = nessun handshake

XACCESO-XSPENTO = XACCESO/XSPENTO handshake

HARDWARE = hardware handshake

H.SHAKE

Handshake

NONE

Nessuno

ON-OFF

Xaccesso / Xspento

HARDW

Hardware

5.6 Impostazioni di Stampa

Inviare in questo sottomenu per personalizzare le impostazioni di trasferimento dei dati

Print

5.6.1 Solamente Stabile

Spento = i valori vengono stampati immediatamente indipendentemente dalla stabilità.

Acceso = i valori vengono stampati solamente quando i criteri di stabilità vengono soddisfatti.

STABLE

5.6.2 Solamente Numerici

Spento = tutti i risultati selezionati vengono stampati.

Acceso = Solamente i valori dei dati numerici vengono stampati.

NUM

5.6.3 Intestazione Singola

<p>Spento = le Intestazioni saranno stampate per ogni requisito di stampa. Acceso = le Intestazioni saranno stampate una volta al giorno.</p>	<p>5 in.HEAD</p>
---	------------------

5.6.4 Auto-Stampa

<p>Abilitare o disabilitare il funzionamento di auto-stampa, e impostare la modalità specifica di auto-stampa.</p>	<p>A.Pr int</p>
--	-----------------

<p>1. Spento = disattivato</p>	<p>OFF</p>
---------------------------------------	------------

<p>2. Acceso Stabilità = la stampa avviene quando i criteri di stabilità sono soddisfatti.</p>	<p>ON.StAb</p>
--	----------------

<p>Quando viene selezionato Acceso Stabilità, impostare le condizioni per la stampa. Carico = Stampa quando il carico visualizzato è stabile.</p>	<p>LoAd</p>
<p>Carico e Zero = Stampa quando il carico e zero visualizzati sono stabili.</p>	<p>LoAd.ZEr</p>

<p>3. Intervallo di Stampa = la stampa avviene al tempo d'intervallo predefinito. Quando viene selezionato Intervallo di Stampa, impostare il tempo d'intervallo usando la tastiera numerica. Nota: Impostazioni da 1 a 3.600 secondi sono disponibili. Il predefinito è 0.</p>	<p>IntEr</p>
---	--------------

<p>4. Continuo = la stampa avviene in modo continuo.</p>	<p>Cont inu</p>
--	-----------------

5.6.5 Intestazione

<p>Acceso = l'intestazione viene stampata. Spento = l'intestazione non viene stampata.</p>	<p>HEADEr</p>
--	---------------

5.6.6 Data e Orario

<p>Acceso = la data e l'orario vengono stampati. Spento = ne la data e neanche l'orario vengono stampati.</p>	
--	---

5.6.7 ID della Bilancia

<p>Acceso = l'ID della bilancia viene stampato. Spento = l'ID della bilancia non viene stampato.</p>	
---	---

5.6.8 Nome della Bilancia

<p>Acceso = il nome della bilancia viene stampato. Spento = il nome della bilancia non viene stampato.</p>	
---	---

5.6.9 Nome dell'Utente

<p>Acceso = il nome dell'Utente viene stampato. Spento = il nome dell'Utente non viene stampato.</p>	
---	---

5.6.10 Nome del Progetto

<p>Acceso = il nome del progetto viene stampato. Spento = il nome del progetto non viene stampato.</p>	
---	---

5.6.11 Nome dell'Applicazione

<p>Acceso = il nome dell'applicazione viene stampato Spento = il nome dell'applicazione non viene stampato.</p>	
--	---

5.6.12 Risultato

<p>Acceso = il risultato della pesatura viene stampato. Spento = il risultato della pesatura non viene stampato.</p>	
---	---

5.6.13 Lordo

<p>Acceso = il peso lordo viene stampato. Spento = il peso lordo non viene stampato.</p>	
---	---

5.6.14 Netto

<p>Acceso = il peso netto viene stampato. Spento = il peso netto non viene stampato.</p>	<p>NET</p>
---	------------

5.6.15 Taratura

<p>Acceso = il peso della taratura viene stampato. Spento = il peso della taratura non viene stampato.</p>	<p>TARE</p>
---	-------------

5.6.16 Riga per la firma

<p>Acceso = viene stampata la Signature Line. Spento = la Signature Line non viene stampata.</p>	<p>SIGN.L IN</p>
---	------------------

5.6.17 Alimentazione della Linea

<p>1 Linea = spostare la carta in su una linea dopo la stampa. 4 Linee = spostare la carta in su quattro linee dopo la stampa.</p>	<p>FEED</p>
<p>1 LINE 1 Linea</p>	<p>4 LINES 4 Linee</p>

5.7 GLP (Buone Pratiche di Laboratorio)

<p>Inviare questo menu per impostare le GLP (Buone Pratiche di Laboratorio).</p>	<p>GLP</p>
--	------------

5.7.1 Intestazione

<p>Attiva la stampa delle intestazioni GLP. Esistono fino a 3 intestazioni disponibili.</p> <p>Sono disponibili delle impostazioni alfanumeriche fino a 16 caratteri per ogni impostazione dell'Intestazione.</p>	<p>HEADER 1 Intestazione 1</p>
<p>HEADER 2 Intestazione 2</p>	<p>HEADER 3 Intestazione 3</p>

5.7.2 Nome della Bilancia

<p>Impostare il nome della bilancia. Sono disponibili delle impostazioni alfanumeriche fino a 16 caratteri per ogni impostazione dell'Intestazione.</p>	<p>BAL.NAM</p>
---	----------------

5.7.3 Nome dell'Utente

<p>Impostare il nome dell'Utente. Sono disponibili delle impostazioni alfanumeriche fino a 16 caratteri per ogni impostazione dell'Intestazione.</p>	
--	---

5.7.4 Nome del Progetto

<p>Impostare il nome dell'Utente. Sono disponibili delle Impostazioni alfanumeriche fino a 16 caratteri per ogni impostazione dell'Intestazione. L'impostazione predefinita è vuota.</p>	
---	---

5.8 Ripristino Impostazioni di Fabbrica

<p>Usare questo sottomenu per ripristinare tutte le impostazioni del menu alle impostazioni predefinite di Fabbrica. Ripristinare Tutto = reimposta tutti i menu alle impostazioni predefinite di Fabbrica. Esci = tornare alla schermata principale dell'applicazione senza reimpostare alcun menu. .</p>	
--	---

5.9 Bloccaggio

<p>Usare questo sottomenu per bloccare/sbloccare certi menu. Spento = il menu è sbloccato. Acceso = il menu è bloccato.</p>	
--	---

6. (LFT) LEGALE PER IL COMMERCIO

Quando la bilancia viene utilizzata in commercio o in un'applicazione legalmente controllata, deve essere installata, verificata e sigillata in conformità con le normative locali per Pesì e Misurazioni. È responsabilità dell'acquirente assicurarsi che **tutti i requisiti legali pertinenti** siano soddisfatti.

6.1 Impostazioni

Prima della verifica e della sigillatura, eseguire i seguenti passaggi nell'ordine:

1. Verificare che le impostazioni del menu soddisfino i regolamenti locali in materia di pesi e misure.
2. Verificare che le unità abilitate soddisfino i regolamenti locali in materia di pesi e misure.
3. Eseguire una calibrazione come spiegato nella sezione Calibrazione.
4. Entrare nel menu Calibrazione e impostare la Calibrazione interna, assicurandosi che sia conforme alle normative locali su pesi e misure.
 - a) Premere il pulsante **Tare/Menu-Cal** e selezionare **InCal**.
 - b) Premere il pulsante **Print/Unit** per mettere l'impostazione Calibrazione interna su **On** o **Off**.
Attenzione: La calibrazione interna deve essere disabilitata quando la bilancia viene utilizzata per scopi commerciali in Canada.
 - c) Premere il pulsante **Zero** per confermare, e poi premere il pulsante **Tare/Menu-Cal** per uscire dal menu.
5. Abilitare la Modalità approvata nel menu Impostazione bilancia. Per i modelli con dimensioni di graduazione selezionabili, impostare il valore desiderato nel menu LFT come spiegato nella sezione **Modalità approvata**.
6. Per i modelli certificati Measurement Canada e NTEP con dimensioni di graduazione selezionabili, attaccare l'etichetta di capacità e leggibilità appropriata alla bilancia nella posizione mostrata sotto.
 - a) Recuperare il set di due etichette dalla confezione.
 - b) Prendere l'etichetta che corrisponde alla dimensione della graduazione impostata nel menu LFT.
 - c) Rimuovere il coperchio protettivo di plastica trasparente dal terminale, se presente.
 - d) Rimuovere il rivestimento dal supporto adesivo e attaccare l'etichetta all'area sopra il display.
 - e) Reinstallare il coperchio protettivo di plastica trasparente, se presente.

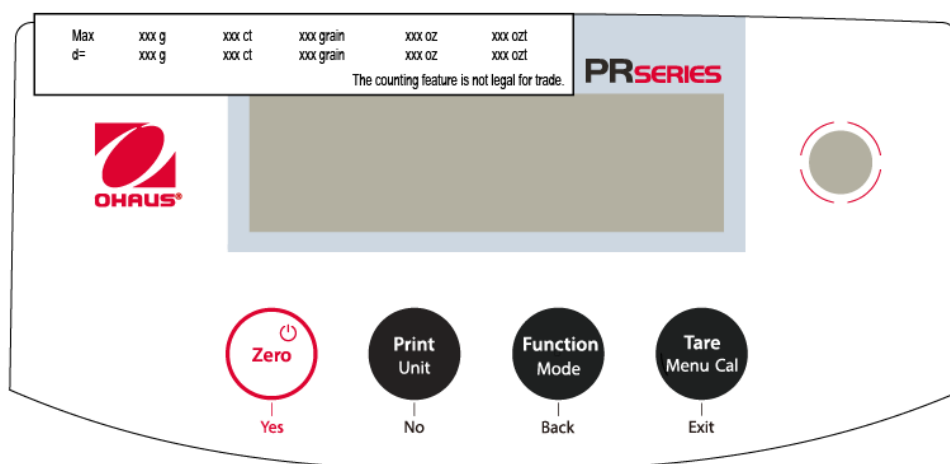

Nota: Quando la Modalità Approvata è impostata su Acceso, la taratura esterna non può essere eseguita.

6.2 Verifica

La procedura di verifica deve essere eseguita da un funzionario o agente dei servizi autorizzato Pesi e Misurazioni.

6.3 Sigillatura

Dopo che la bilancia è stata verificata, deve essere sigillata per impedire accesso non rilevato alle impostazioni legalmente regolate. Prima di sigillare il dispositivo, assicurarsi che l'interruttore di sicurezza si trovi in posizione di Blocco e che l'impostazione della Modalità Approvata nel menu Bilancia Gestione sia stata impostata su ACCESO.

- Se si utilizza un sigillo di carta, porlo sull'interruttore di sicurezza e l'alloggiamento inferiore come mostrato.
- Se si utilizza un sigillo metallico, passare il filo di tenuta attraverso i fori nell'interruttore di sicurezza e l'alloggiamento inferiore come mostrato.



Figura 6-1. Sigillatura

7. STAMPA

7.1 Collegare, configurare and Provare la Stampante/Interfaccia del Computer

Usare l'incorporata porta RS-232 per collegare sia ad un Computer o a una Stampante.

Se si dovesse collegare ad un Computer, usare HyperTerminal o un software simile al SPDC descritto di seguito.

(Trovare HyperTerminal sotto **Accessori/Comunicazioni** in Windows XP.)

Collegarsi al Computer con un cavo seriale standard (diretto).

Scegliere **Nuovo collegamento**, "connetti utilizzando" COM1 (o porta COM disponibile).

Selezionare **Baud=9600; Parità=8 Nessuna; Stop=1; Handshaking=Nessuno**. Cliccare **OK**.

Scegliere Proprietà/Impostazioni, quindi Impostazione ASCII. Controllare le caselle come illustrato:

(Invia fine linee ...; Caratteri tipo Eco ...; Avvolgi-linee ...)

Usare Controlli Interfaccia RS232 (Sezione 9.6.1) per controllare la bilancia da un PC.

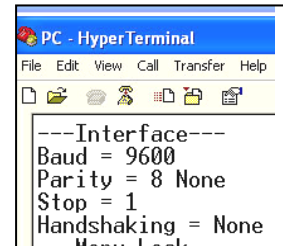

Software SPDC

Il software Seriale Porta SPDC/Raccogli Dati è fornito da Ohaus e può essere utilizzato su sistemi operativi che non dispongono del software HyperTerminal menzionato in precedenza. Il software SPDC può raccogliere e trasferire in modo preliminare i dati ai file Microsoft (come Excel, Word, ecc.). Scegliere il tipo di file di esportazione e il percorso del file di esportazione, quindi premere Esegui come mostrato di seguito.

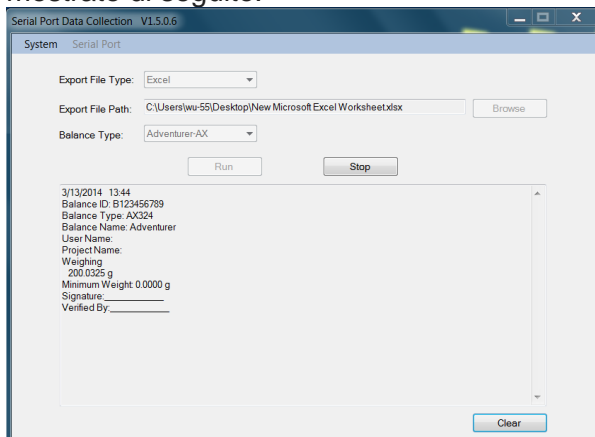

Requisiti del Sistema

- Il PC esegue con Windows 98®, Windows 98SE®, Windows ME®, Windows 2000®, Windows XP®, Windows 7® o Windows 8® (32-bit).

Nota: il più recente software SPDC di supporto della lingua inglese e cinese e può essere scaricato dal sito web di Ohaus. Per ulteriori informazioni, fare riferimento al *Manuale di Istruzioni della Raccolta Dati SPDC*.

7.2 Formato di Output

I Dati Risultanti e i dati G/N/T vengono emessi nel seguente formato

Campo:	Etichetta ¹	Spazio ²	Peso ³	Spazio ²	Unità ⁴	Spazio	Stabilità ⁵	Spazio	G/N ⁶	Spazio	Term. Caratteri ⁷
Lunghezza:		1	11	1	5	1	≤ 1	≤ 1	≤ 3	0	≤ 8

Nota:

1. La lunghezza del campo dell'etichetta non è fissa.
2. Ogni campo è seguito da un singolo spazio di delimitazione (ASCII 32).
3. Il campo Peso è composto da 11 caratteri giustificati a destra. Se il valore è negativo, il carattere '-' si trova all'immediata sinistra della cifra più rilevante.
4. Il campo Unità contiene l'abbreviazione di unità di misura fino a 5 caratteri, giustificata a destra.
5. Il campo Stabilità contiene il carattere "?" se la lettura del peso non è stabile. Il campo Stabilità e il seguente campo Spazio vengono omessi se la lettura del Peso è stabile.
6. Il campo G/N contiene l'indicazione netto o lordo. Per i pesi netti, il campo contiene "N". Per i pesi lordi, il campo contiene "G".
7. Il campo Fine Caratteri contiene CRLF, Quattro CRLF o Modulo di Alimentazione (ASCII 12), secondo l'impostazione del menu LINE FEED (ALIMENTAZIONE LINEA).
8. Quando Solamente Numerici è impostato su Acceso, solamente il Campo Peso è stampato, allineato a sinistra.

7.3 Esempi di Stampa

Esempi per ogni Applicazione sono mostrati con tutti gli articoli **ACCESI** nel menu **Stampa**. Vengono inoltre visualizzati i valori predefiniti per le linee 1-3 dell'**Intestazione**.

Pesatura Base

Header 1
Header 2
Header 3
07/19/2017 17:56:23
Balance ID: B234567890
Balance Name: PR4202/E
User Name:
Project Name:
Weigh
0.10 g
Gross: 0.10 g G
Net: 0.10 g N
Tare: 0.00 g T
Signature: _____
Verified By: _____

Pesatura di Conteggio

Header 1
Header 2
Header 3
07/19/2017 17:57:19
Balance ID: B234567890
Balance Name: PR4202/E
User Name:
Project Name:
Count
Quantity: 4999 PCS
Gross: 49.99 g G
Net: 49.99 g N
Tare: 0.00 g T
APW: 0.010 g
Sample Size: 10 PCS
Signature: _____
Verified By: _____

Pesatura Percento

Header 1
Header 2
Header 3
07/19/2017 17:57:19
Balance ID: B234567890
Balance Name: PR223/E
User Name:
Project Name:
Percent
Percentage: 10.156 % N
Gross: 23.361 g G
Net: 10.156 g N
Tare: 13.205 g T
Reference weight: 100.000 g
Signature: _____
Verified By: _____

Taratura Interna

-OHAUS-
07/26/2017 05:16:53
Balance ID:
Balance Name: PR2202
User Name:
Project Name:
---Internal Calibration---
Calibration is done.
Difference weight: 0.00 g

Signature: _____
Verified By: _____

Taratura di Portata

-OHAUS-
07/26/2017 05:16:37
Balance ID:
Balance Name: PR2202
User Name:
Project Name:
---Span Calibration---
Calibration is done.
Reference weight: 2000.00 g
Actual weight: 2000.22 g
Difference weight: 0.22 g
Weight ID: _____

Signature: _____
Verified By: _____

Taratura di Linearità

-OHAUS-
07/26/2017 05:16:11
Balance ID:
Balance Name: PR2202
User Name:
Project Name:
---Linear Calibration---
Calibration is done.

Signature: _____
Verified By: _____

8. MANUTENZIONE

8.1 Taratura

Verificare periodicamente la taratura ponendo un preciso peso sulla bilancia e visualizzando il risultato. Se la taratura dovesse essere richiesta, fare riferimento alla Sezione 5.2 per ulteriori istruzioni.

8.2 Pulizia



AVVERTIMENTO: Disconnettere la bilancia dall'alimentazione di corrente elettrica, prima di iniziare la pulizia.
Assicurarsi che nessun liquido penetra l'interno della bilancia.





Pulire la bilancia a intervalli regolari.



Le superfici degli alloggi domestici possono essere pulite con un panno privo di lanugine leggermente inumidito con acqua o un detergente delicato.

Le superfici in vetro possono essere pulite con un detergente per vetri in vendita in commercio.
Attenzione: Non usare solventi, prodotti chimici aggressivi, ammoniaca o agenti abrasivi per la pulizia.

8.3 Risoluzione dei Problemi

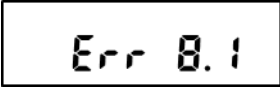
TABELLA 8-1. RISOLUZIONE DEI PROBLEMI

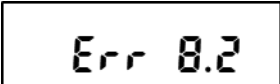
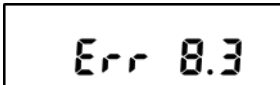
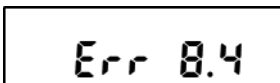
Sintomo/Visualizzazione	Possibile causa	Soluzione
Impossibile cambiare le impostazioni del menu 	Il sotto-menu è bloccato.	Sbloccare il sotto-menu nel menu di blocco.
Alcuni sotto-menu sono nascosti.	Questo è un modello approvato, che richiede di bloccare certi sotto-menu.	Impostare la bilancia prima di attivare l'impostazione Legal for Trade.
	L'ambiente non è stabile.	Spostare la bilancia in un luogo adatto e calibrare di nuovo
	Vengono utilizzate masse di calibrazione non corrette.	Utilizzare le masse di calibrazione per calibrare in base ai punti di calibrazione corretti inclusi nella tabella delle specifiche del manuale di istruzioni.
	Errore del sistema	Se l'errore persiste, contattare l'assistenza OHAUS (www.ohaus.com - Di più - Contattaci)
	All'accensione viene utilizzato un piatto per la pesatura sbagliato.	Utilizzare il piatto di pesatura originale OHAUS prima dell'accensione.
	Il carico sul piatto è superiore al peso iniziale impostato.	Rimuovere il carico dal piatto prima dell'accensione.

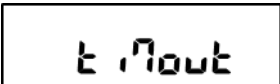
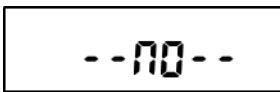
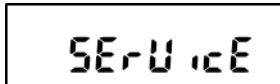
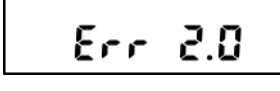
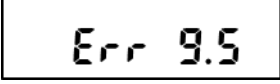
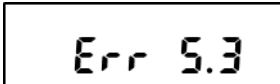
	All'accensione viene utilizzato un piatto per la pesatura sbagliato.	Utilizzare il piatto di pesatura originale OHAUS prima dell'accensione.
	Il piatto non è installato quando la bilancia è accesa.	Installare il piatto di pesatura prima dell'accensione.
	Il peso del piatto è troppo pesante.	Ridurre la dimensione del campione fino a quando il peso rientra nella capacità di pesatura.
	Il piatto non è installato correttamente.	Installare correttamente il piatto di pesatura
	Il peso medio del pezzo del campione è troppo piccolo (meno di 0,1d) nella modalità di conteggio dei pezzi.	Ricalcolare il valore APW. Se l'errore persiste, si prega di utilizzare un campione diverso.
	Il peso di riferimento sul piatto è troppo piccolo (meno di 100d) in modalità Pesatura percentuale.	Mettere più campioni sul piatto
	Errore del sistema	Si prega di contattare l'assistenza OHAUS (www.ohaus.com - Di più - Contattaci)
	L'ambiente non è stabile.	Spostare la bilancia in un luogo adatto
Quando si preme Tara/Zero		Il valore è fuori dal range dello zero. Il range dello zero dipende dalla regione.
		Il valore di tara è un valore negativo.
	Errore del sistema	Si prega di contattare l'assistenza OHAUS (www.ohaus.com - Di più - Contattaci)
  	Errore del sistema	Scollegare l'alimentazione e riavviare. Se l'errore persiste, contattare l'assistenza OHAUS (www.ohaus.com - Di più - Contattaci)

8.4 Informazione di Servizio

Se la sezione Risoluzione dei Problemi non risolve i vostri problemi, contattare un Agente di Servizio Ohaus Autorizzato. Si prega di visitare il nostro sito web www.ohaus.com per localizzare l'ufficio Ohaus a voi più vicino.

9. DATI TECNICI

9.1 Specifiche

Condizioni ambientali

- Solamente uso interno
- Altitudine: Fino a 2.000 m
- Specificata gamma della Temperatura: da 10 °C a 30 °C
- Umidità: massima Umidità Relativa 80% per temperature fino a 30 °C, diminuendo in modo lineare al 50% di Umidità Relativa a 40 °C
- L'operabilità viene assicurata a temperature ambiente comprese tra 5 °C e 40 °C
- Fluttuazioni della tensione d'alimentazione di rete: fino a $\pm 10\%$ della tensione nominale
- Categoria d'installazione II
- Grado d'inquinamento: 2
- Tensione di alimentazione: 12V=0.5A

Materiali

- Alloggiamento Inferiore: Alluminio Pressofuso, Verniciato + Plastica (HIPS)
- Alloggiamento Superiore: Plastica (HIPS)
- Piattaforme di pesatura: acciaio inossidabile
- Schermo di Tiraggio: Vetro, plastica (HIPS)
- Piedi: Plastica (ABS).

Tabella 9-1. SPECIFICHE

Modello InCal		PR124	PR224	PR223	PR423	PR523
Modello ExCal	PR64/E	PR124/E	PR224/E	PR223/E	PR423/E	PR523/E
Capacità (g)	62	120	220	220	420	520
Leggibilità d (g)	0.0001	0.0001	0.0001	0.001	0.001	0.001
Ripetibilità (sd.), ≤5% del full load (g)	0.00008	0.00008	0.00008	0.0008	0.0008	0.0008
Ripetibilità (sd.), 5% di Full Load to Full Range (g)	0.0001	0.0001	0.0001	0.001	0.001	0.001
Deviazione di linearità, tipica (g)	± 0.00006	± 0.00006	± 0.00006	±0.0006	±0.0006	±0.0006
Deviazione di linearità (g)	± 0.0002	± 0.0002	± 0.0002	±0.002	±0.002	±0.002
Tipico tempo di Stabilizzazione (s)	3	3	3	2	2	2
Sensibilità della Derive di Temperatura (PPM/K)	±3	±3	±3	±8	±3	±3
Tipico Peso Minimo USP (USP K=2,U=0.10%)	160 mg	160 mg	160 mg	1.6 g	1.6 g	1.6 g
Min-Peso Ottimizzato (g) (USP, u=0.10%, k=2) SRP ≤ 0.41d*	82 mg	82 mg	82 mg	0.82 g	0.82 g	0.82 g
Unità	Grammi, Milligrammi, Carati, Oncia Oncia Troy, Pennyweight, Grano Taiwan Tael, Newton, Custom 1			Grammi, Milligrammi, Kg, Carati, Oncia Oncia Troy, Pennyweight, Grano, Libbra, Taiwan Tael, Newton, Custom 1		
Applicazioni	Pesatura Basilare; Conteggio delle Parti; Pesatura percento					
Dimensione Piattaforma (diametro, mm)	3.5 in / 9 cm	3.5 in / 9 cm	3.5 in / 9 cm	4.7 in / 12 cm	4.7 in / 12 cm	4.7 in / 12 cm
Taratura Punti della Portata (g)	50, 60	50, 100	100, 200	100, 200	200, 400	300, 500
Taratura Punti della Linearità (g)	0, 30, 60	0, 50, 100	0, 100, 200	0, 100, 200	0, 200, 400	0, 250, 500
Gamma della Taratura	Fino alla capacità per sottrazione					
Alimentazione Energia Elettrica	Potenza di Input: 100-240 V ~ 200 mA 50-60Hz 12-18VA Potenza di Output: 12 VDC 0.5A					
Dimensioni Assemblati (W x D x H) (mm)	201 x 317 x 303 mm 7.9 x 12.5 x 11.9 inch					
Comunicazione	RS232					
Gamma Temperatura di Funzionamento	Condizioni di funzionamento per applicazioni di laboratorio comuni: da +10°C a 30 °C (operatività garantita tra +5°C e 40 °C)					
Gamma Temperatura di Immagazzinaggio	Umidità: massima Umidità Relativa 80% per temperature fino a 30 °C, diminuendo in modo lineare al 50% di Umidità Relativa a 40°C					
Condizioni di Immagazzinaggio	-10°C a 60 °C, umidità 10% al 90%, senza condensa					
Peso Netto	10 lb / 4.5 kg					
Peso di Spedizione	15.4lb / 7 kg					
Dimensioni di Spedizione (W x D x H) (mm)	507 x 387 x 531					

* SRP si riferisce alla deviazione standard per n pesature replicate (n≥10).

Tabella 9-2. SPECIFICHE (ripreso)

Modello InCal	PR1602	PR2202	PR4202		PR4201	PR6201
Modello ExCal	PR1602/E	PR2202/E	PR4202/E	PR2201/E	PR4201/E	PR6201/E
Capacità (g)	1600	2200	4200	2200	4200	6200
Leggibilità d (g)	0.01	0.01	0.01	0.1	0.1	0.1
Ripetibilità (sd.), ≤5% del full load (g)	0.008	0.008	0.008	0.08	0.08	0.08
Ripetibilità (sd.), 5% di Full Load to Full Range (g)	0.01	0.01	0.01	0.1	0.1	0.1
Deviazione di linearità, tipica (g)	±0.006	±0.006	±0.006	±0.06	±0.06	±0.06
Deviazione di linearità (g)	±0.02	±0.02	±0.02	±0.2	±0.2	±0.2
Tipico tempo di Stabilizzazione (s)	1	1	1	1	1	1
Sensibilità della Derive di Temperatura (PPM/K)	±6	±6	±3	±10	±10	±10
Tipico Peso Minimo USP (USP K=2,U=0.10%)	16 g	16 g	16 g	160 g	160 g	160 g
Min-Peso Ottimizzato (g) (USP, u=0.10%, k=2) SRP ≤ 0.41d*	8.2 g	8.2 g	8.2 g	82 g	82 g	82 g
Unità	Grammo, Kilogrammo, Carato, Newton, Libbra, Oncia, Oncia Troy, Grano, Taiwan Tael, Custom 1					
Applicazioni	Pesatura Basilare; Conteggio delle Parti; Pesatura percento					
Dimensione Piattaforma (diametro, mm)	7.1 in / 18 cm	7.1 in / 18 cm	7.1 in / 18 cm	7.1 in / 18 cm	7.1 in / 18 cm	7.1 in / 18 cm
Taratura Punti della Portata (g)	1000, 1500, 1600	1000, 2000	2000, 4000	1000, 2000	2000, 4000	5000, 6000
Taratura Punti della Linearità (g)	0, 800, 1600	0, 1000, 2000	0, 2000, 4000	0, 1000, 2000	0, 2000, 4000	0, 3000, 6000
Gamma della Taratura	Fino alla capacità per sottrazione					
Alimentazione Energia Elettrica	Potenza di Input: 100-240 V ~ 200 mA 50-60Hz 12-18VA Potenza di Output: 12 VDC 0.5A					
Dimensioni Assemblati (W x D x H) (mm)	201 x 317 x 93 mm 7.9 x 12.5 x 3.7 inch					
Comunicazione	RS232					
Gamma Temperatura di Funzionamento	Condizioni di funzionamento per applicazioni di laboratorio comuni: da +10°C a 30 °C (operatività garantita tra +5°C e 40 °C)					
Gamma Temperatura di Immagazzinaggio	Umidità: massima Umidità Relativa 80% per temperature fino a 30 °C, diminuendo in modo lineare al 50% di Umidità Relativa a 40°C					
Condizioni di Immagazzinaggio	-10°C a 60 °C, umidità 10% al 90%, senza condensa					
Peso Netto	7.7 lb / 3.5 kg					
Peso di Spedizione	11 lb / 5 kg					
Dimensioni di Spedizione (W x D x H) (mm)	550 x 385 x 291					

* SRP si riferisce alla deviazione standard per n pesature replicate (n≥10).

Tabella 9-3. SPECIFICHE (ripreso)

Modello InCal		PR523N
Modello ExCal	PR323N/E	PR523N/E
Capacità (g)	320	520
Leggibilità d (g)	0.001 o 0.01	0.001 o 0.01
Intervallo di Verifica e (g)	0.01	0.01
Classe	II	II
Ripetibilità (sd.), ≤5% del full load (g)	0.0008	0.0008
Ripetibilità (sd.), 5% di Full Load to Full Range (g)	0.001	0.001
Deviazione di linearità, tipica (g)	± 0.0006	± 0.0006
Deviazione di linearità (g)	± 0.002	± 0.002
Carico eccentrico	Non superare l'errore massimo tollerato per un terzo della piena capacità della bilancia	
Tipico tempo di Stabilizzazione (s)	2	2
Sensibilità della Derive di Temperatura (PPM/K)	±3	±3
Tipico Peso Minimo USP (USP K=2,U=0.10%)	1.6g	1.6g
Min-Peso Ottimizzato (g) (USP, u=0.10%, k=2) ; SRP ≤ 0.41d*	0.82g	0.82g
Unità	Grammo, Milligrammo, Carato, Oncia, Oncia Troy, Grano	
Applicazioni	Pesatura Basilare; Conteggio delle Parti; Pesatura percento	
Dimensione Piattaforma (diametro)	4.7 in / 12 cm	4.7 in / 12 cm
Taratura Punti della Portata (g)	200,300	300, 500
Taratura Punti della Linearità (g)	0, 150, 300	0, 250, 500
Gamma della Taratura	Fino alla capacità per sottrazione	
Alimentazione Energia Elettrica	Potenza di Input: 100-240 V ~ 200 mA 50-60Hz 12-18VA Potenza di Output: 12 VDC 0.5A	
Dimensioni Assemblati (W x D x H) (mm)	201 x 317 x 303 mm 7.9 x 12.5 x 11.9 inch	
Comunicazione	RS232	
Gamma Temperatura di Funzionamento	Condizioni di funzionamento per applicazioni di laboratorio comuni: da +10°C a 30 °C (operatività garantita tra +5°C e 40 °C)	
Gamma Temperatura di Immagazzinaggio	Umidità: massima Umidità Relativa 80% per temperature fino a 30 °C, diminuendo in modo lineare al 50% di Umidità Relativa a 40°C	
Condizioni di Immagazzinaggio	-10°C a 60 °C, umidità 10% al 90%, senza condensa	
Peso Netto	10 lb / 4.5 kg	10 lb / 4.5 kg
Peso di Spedizione	15.4 lb / 7 kg	15.4 lb / 7 kg
Dimensioni di Spedizione (W x D x H) (mm)	507 x 387 x 531mm 20 x 15 x 21 inch	

* SRP si riferisce alla deviazione standard per n pesature replicate (n≥10).

Tabella 9-4. SPECIFICHE (ripreso)

Modello ExCal	PR322N/E	PR522N/E	PR822N/E	PR2202N/E	PR4202N/E	PR5202N/E
Capacità (g)	320	520	820	2200	4200	5200
Leggibilità d (g)	0.01	0.01	0.1	0.01 o 0.1	0.01 o 0.1	0.01 o 0.1
Intervallo di Verifica e (g)	0.01	0.01	0.1	0.1	0.1	0.1
Classe	II	II	III	II	II	II
Ripetibilità (sd.), ≤5% del full load (g)	0.008	0.008	0.008	0.008	0.008	0.008
Ripetibilità (sd.), 5% di Full Load to Full Range (g)	0.01	0.01	0.01	0.01	0.01	0.01
Deviazione di linearità, tipica (g)	±0.006	±0.006	±0.006	±0.006	±0.006	±0.006
Deviazione di linearità (g)	±0.02	±0.02	±0.02	±0.02	±0.02	±0.02
Carico eccentrico	Non superare l'errore massimo tollerato per un terzo della piena capacità della bilancia					
Tipico tempo di Stabilizzazione (s)	1	1	1	1	1	1
Sensibilità della Derive di Temperatura (PPM/K)	±3	±3	±6	±6	±3	±3
Tipico Peso Minimo USP (USP K=2,U=0.10%)	16g	16g	16g	16g	16g	16g
Min-Peso Ottimizzato (g) (USP, u=0.10%, k=2); SRP ≤ 0.41d*	8.2g	8.2g	8.2g	8.2g	8.2g	8.2g
Unità	Grammo, Kilogrammo, Carato, Libbra, Oncia, Oncia Troy, Grano					
Applicazioni	Pesatura Basilare; Conteggio delle Parti; Pesatura percento					
Dimensione Piattaforma (diametro)	4.7 in / 12 cm			7.1 in / 18 cm		
Taratura Punti della Portata (g)	200, 300	300,500	500,800	1000, 2000	2000, 4000	3000, 5000
Taratura Punti della Linearità (g)	0, 150, 300	0, 250, 500	0, 400, 800	0, 1000, 2000	0, 2000, 4000	0, 2500, 5000
Gamma della Taratura	Fino alla capacità per sottrazione					
Alimentazione Energia Elettrica	Potenza di Input: 100-240 V ~ 200 mA 50-60Hz 12-18VA Potenza di Output: 12 VDC 0.5A					
Dimensioni Assemblati (W x D x H) (mm)	201 x 317 x 303 mm 7.9 x 12.5 x 11.9 inch			201 x 317 x 93 mm 7.9 x 12.5 x 3.7 inch		
Comunicazione	RS232					
Gamma Temperatura di Funzionamento	Condizioni di funzionamento per applicazioni di laboratorio comuni: da +10°C a 30 °C (operatività garantita tra +5°C e 40 °C)					
Gamma Temperatura di Immagazzinaggio	Humidity: maximum relative humidity 80 % for temperatures up to 30°C, decreasing linearly to 50% relative humidity at 40°C					
Condizioni di Immagazzinaggio	-10°C to 60°C, humidity 10% to 90%, without condensation					
Peso Netto	10 lb / 4.5 kg			7.7 lb / 3.5 kg		
Peso di Spedizione	15.4 lb / 7 kg			11 lb / 5 kg		
Dimensioni di Spedizione (W x D x H) (mm)	507 x 387 x 531 mm 20 x 15 x 21 inch			550 x 385 x 291 mm 22 x 15 x 12 inch		

* SRP si riferisce alla deviazione standard per n pesature replicate (n≥10).

Tabella 9-5. SPECIFICHE (ripreso)

Modello ExCal	PR2201N/E	PR4201N/E	PR5201N/E	PR6201N/E
Capacità (g)	2200	4200	5200	6200
Leggibilità d (g)	0.1	0.1	0.1	0.1 o 1
Intervallo di Verifica e (g)	0.1	0.1	0.1	1
Classe	II	II	II	III
Ripetibilità (sd.), ≤5% del full load (g)	0.08	0.08	0.08	0.08
Ripetibilità (sd.), 5% di Full Load to Full Range (g)	0.1	0.1	0.1	0.1
Deviazione di linearità, tipica (g)	±0.06	±0.06	±0.06	±0.06
Deviazione di linearità (g)	±0.2	±0.2	±0.2	±0.2
Carico eccentrico	Non superare l'errore massimo tollerato per un terzo della piena capacità della bilancia			
Tipico tempo di Stabilizzazione (s)	1	1	1	1
Sensibilità della Derive di Temperatura (PPM/K)	±10	±10	±3	±10
Tipico Peso Minimo USP (USP K=2,U=0.10%)	160g	160g	160g	160g
Min-Peso Ottimizzato (g) (USP, u=0.10%, k=2) SRP ≤ 0.41d*	82g	82g	82g	82g
Unità	Grammo, Kilogrammo, Carato, Libbra, Oncia, Oncia Troy, Grano			
Applicazioni	Pesatura Basilare; Conteggio delle Parti; Pesatura percento			
Dimensione Piattaforma (diametro)	7.1 in / 18 cm			
Taratura Punti della Portata (g)	1000, 2000	2000, 4000	3000, 5000	5000, 6000
Taratura Punti della Linearità (g)	0, 1000, 2000	0, 2000, 4000	0, 2500, 5000	0, 3000, 6000
Gamma della Taratura	Fino alla capacità per sottrazione			
Alimentazione Energia Elettrica	Potenza di Input: 100-240 V ~ 200 mA 50-60Hz 12-18VA Potenza di Output: 12 VDC 0.5A			
Dimensioni Assemblati (W x D x H) (mm)	201 x 317 x 93 mm 7.9 x 12.5 x 3.7 inch			
Comunicazione	RS232			
Gamma Temperatura di Funzionamento	Condizioni di funzionamento per applicazioni di laboratorio comuni: da +10°C a 30 °C (operatività garantita tra +5°C e 40 °C)			
Gamma Temperatura di Immagazzinaggio	Humidity: maximum relative humidity 80 % for temperatures up to 30°C, decreasing linearly to 50% relative humidity at 40°C			
Condizioni di Immagazzinaggio	-10°C to 60°C, humidity 10% to 90%, without condensation			
Peso Netto	7.7 lb / 3.5 kg			
Peso di Spedizione	11 lb / 5 kg			
Dimensioni di Spedizione (W x D x H) (mm)	550 x 385 x 291 mm 22 x 15 x 12 inch			

* SRP si riferisce alla deviazione standard per n pesature replicate (n≥10).

Table 9-6 SPECIFICHE (ripreso)

Modello Approvato InCal	PR124M	PR224M	PR223M	PR323M	PR423M	PR523M
Capacità (g)	120	220	220	320	420	520
Leggibilità d (g)	0.0001	0.0001	0.001	0.001	0.001	0.001
Intervallo di Verifica e (g)	0.001	0.001	0.01	0.01	0.01	0.01
Classe	I	I	II	II	II	II
Ripetibilità (sd.), ≤5% del full load (g)	0.00008	0.00008	0.0008	0.0008	0.0008	0.0008
Ripetibilità (sd.), 5% di Full Load to Full Range (g)	0.0001	0.0001	0.001	0.001	0.001	0.001
Deviazione di linearità, tipica (g)	± 0.00006	± 0.00006	±0.0006	±0.0006	±0.0006	±0.0006
Deviazione di linearità (g)	± 0.0002	± 0.0002	±0.002	±0.002	±0.002	±0.002
Tipico Tempo di Stabilizzazione (s)	3	3	2	2	2	2
Sensibilità della Deriva di Temperatura (PPM/K)	±3	±3	±3	±3	±3	±3
Tipico Peso Minimo USP (USP K=2,U=0,10%)	160 mg	160 mg	1.6 g	1.6 g	1.6 g	1.6 g
Peso Minimo Ottimizzato (g) (USP, u=0,10%, k=2) SRP≤0.41d*	82 mg	82 mg	0.82 g	0.82 g	0.82 g	0.82 g
Unità	g, mg , ct					
Applicazioni	Pesate di Base, Conteggio Pezzi, Pesata Percento, Pesata Dinamica, Determinazione della Densità					
Dimensione Piattaforma (diametro, mm)	90	90	120	120	120	120
Taratura Punti della Portata (g)	50, 100	100, 200	100, 200	200, 300	200, 400	300, 500
Taratura Punti della Linearità (g)	0, 50, 100	0, 100, 200	0, 100, 200	0, 150, 300	0, 200, 400	0, 250, 500
Gamma della Taratura	Fino alla capacità per sottrazione					
Alimentazione Energia Elettrica	Potenza di Input: 12 V CC 1A da CA/CC alimentazione di corrente esterna Potenza di Output: 12 VDC 0.5A					
Dimensioni Assemblati (W x D x H) (mm)	209 x 321 x 309					
Comunicazione	RS232					
Gamma Temperatura di Funzionamento	Condizioni di funzionamento per applicazioni di laboratorio comuni: da +10°C a 30 °C (operatività garantita tra +5°C e 40 °C)					
Gamma Temperatura di Immagazzinaggio	Umidità: Massima Umidità Relativa 80% per temperature fino a 30 °C, diminuendo in modo lineare a 40 °C al 50% di Umidità Relativa					
Condizioni di Immagazzinaggio	Da -10°C a 60 °C, umidità dal 10% al 90%, senza condensa					
Peso Netto	10 lb / 4.5 kg					
Peso di Spedizione	15.4 lb / 7 kg					
Dimensioni di Spedizione (W x D x H) (mm)	507 x 387 x 531					

* SRP si riferisce alla deviazione standard per n pesature replicate (n≥10).

Table 9-7 SPECIFICHE (ripreso)

Modello Approvato InCal	PR1602M	PR2202M	PR4202M	PR5202M	PR4201M	PR6201M
Capacità (g)	1600	2200	4200	5200	4200	6200
Leggibilità d (g)	0.01	0.01	0.01	0.01	0.1	0.1
Intervallo di Verifica e (g)	0.1	0.1	0.1	0.1	0.1	1
Classe	II	II	II	II	II	II
Ripetibilità (sd.), ≤5% del full load (g)	0.008	0.008	0.008	0.008	0.08	0.08
Ripetibilità (sd.), 5% di Full Load to Full Range (g)	0.01	0.01	0.01	0.01	0.1	0.1
Deviazione di linearità, tipica (g)	±0.006	±0.006	±0.006	±0.006	±0.06	±0.06
Deviazione di linearità (g)	±0.02	±0.02	±0.02	±0.02	±0.2	±0.2
Tipico Tempo di Stabilizzazione (s)	1	1	1	1	1	1
Sensibilità della Deriva di Temperatura (PPM/K)	±3	±3	±3	±3	±10	±10
Tipico Peso Minimo USP (USP K=2,U=0,10%)	16 g	16 g	16 g	16 g	160 g	160 g
Peso Minimo Ottimizzato (g) (USP, u=0,10%, k=2) SRP≤0.41d*	8.2 g	8.2 g	8.2 g	8.2 g	82 g	82 g
Unità	g, kg, ct					
Applicazioni	Pesate di Base, Conteggio Pezzi, Pesata Percento, Pesata Dinamica, Determinazione della Densità					
Dimensione Piattaforma (diametro, mm)	180	180	180	180	180	180
Taratura Punti della Portata (g)	1000, 1500, 1600	1000, 2000	2000, 4000	3000, 5000	2000, 4000	5000, 6000
Taratura Punti della Linearità (g)	0, 800, 1600	0, 1000, 2000	0, 2000, 4000	0, 2500, 5000	0, 2000, 4000	0, 3000, 6000
Gamma della Taratura	Fino alla capacità per sottrazione					
Alimentazione Energia Elettrica	Potenza di Input: 12 V CC 1A da CA/CC alimentazione di corrente esterna Potenza di Output: 12 VDC 0.5A					
Dimensioni Assemblati (W x D x H) (mm)	209 x 321 x 98					
Comunicazione	RS232					
Gamma Temperatura di Funzionamento	Condizioni di funzionamento per applicazioni di laboratorio comuni: da +10°C a 30 °C (operatività garantita tra +5°C e 40 °C)					
Gamma Temperatura di Immagazzinaggio	Umidità: Massima Umidità Relativa 80% per temperature fino a 30 °C, diminuendo in modo lineare a 40 °C al 50% di Umidità Relativa					
Condizioni di Immagazzinaggio	Da -10°C a 60 °C, umidità dal 10% al 90%, senza condensa					
Peso Netto	7.7 lb / 3.5 kg					
Peso di Spedizione	11 lb / 5 kg					
Dimensioni di Spedizione (W x D x H) (mm)	550 x 385 x 291					

* SRP si riferisce alla deviazione standard per n pesature replicate (n≥10).

9.2 Disegni e Dimensioni

Dimensioni di assemblaggio completo



Figura 9-1. Modello 0,001 g / 0,0001 g



Figura 9-2. Modello 0,1 g / 0,01 g

9.3 Accessori

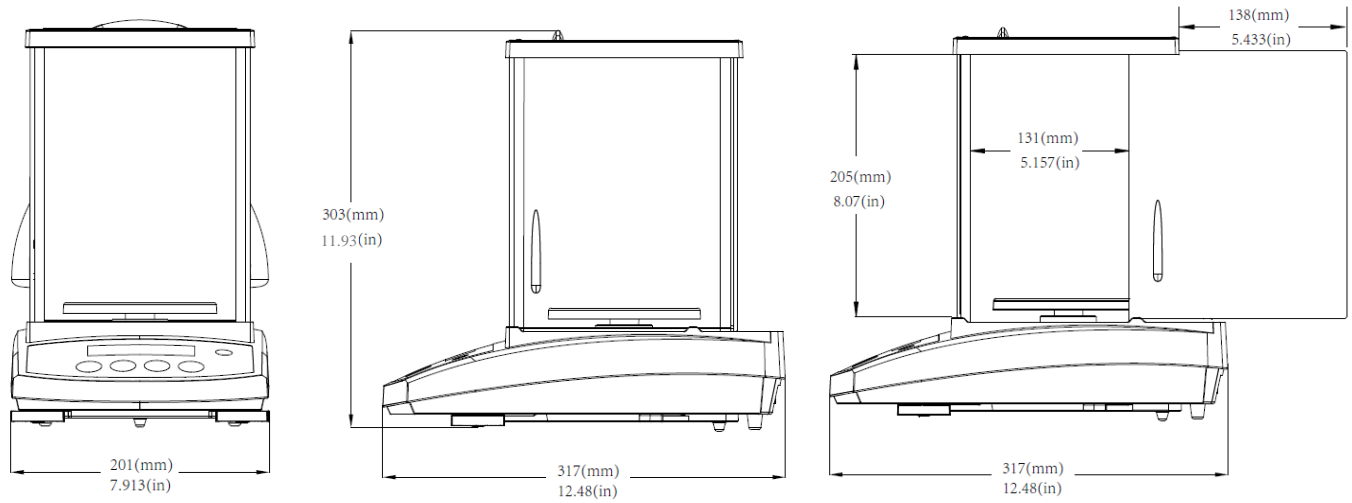
DESCRIZIONE	NUMERO PEZZO DI RICAMBIO
Display Ausiliario AD7-RS	30472064
Dispositivo di Sicurezza	80850043
Cavo RS232 (25 perni)	80500524
Cavo RS232 (9 perni)	80500525
Coperchio antipolvere	30093334
Coperchio in uso	30372547
Stampante SF40A	30064202 (UE); 30064203 (USA)
Adattatore di Energia per la bilancia	46001724

9.4 Comunicazione

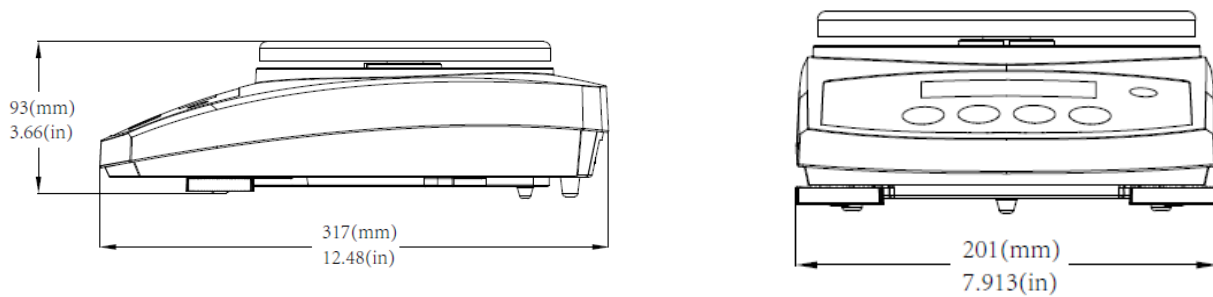
9.4.1 Controlli Interfaccia

I controlli elencati nella seguente tabella saranno riconosciuti dalla bilancia.

Controllo	Funzione
IP	Stampa immediata del peso visualizzato (stabile o non stabile).
P	Stampa del peso visualizzato (stabile o non stabile).
CP	Stampa continua.
SP	Stampa sulla Stabilità.
SLP	Imposta Auto-Stampa alla Stabilità Accesa, consente al peso visualizzato non-zero di essere stampato.
SLZP	Imposta Auto-Stampa alla Stabilità Accesa, consente alla lettura sia del peso non-zero stabile che del stabile zero di essere stampati.
xP	Imposta Auto-Stampa all'Intervallo Stampa, x = intervallo stampa (1-3.600 sec), 0P disattiva l'intervallo Stampa.
0P	0P disattiva l'intervallo Stampa, stampa continua o stampa sulla stabilità
H	Inviare Linee Intestazione Stampa, il formato è: H x "stringa d'intestazione". Dove x = numero delle linee da 1 a 3, "stringa d'intestazione" può essere fino a 24 caratteri alfanumerici. Se il controllo non ha stringhe, "H x" leggerà l'intestazione x memorizzata.
Z	Uguale come premere Tasto Zero
T	Uguale come premere Tasto Taratura
xT***	Stabilire un valore di Taratura preimpostato nell'unità visualizzata. x = valore di taratura preimpostato. Inviando 0T cancella la taratura (se consentito).
PT	Stampa il peso della Taratura memorizzato.
PM	Stampa modalità dell'applicazione corrente (modalità di pesatura).
xM	Impostare modalità dell'applicazione corrente ad x. x dipende dalle applicazioni 1 – Peso 2 – Conteggio 3 – Percento
M	Scorrere fino alla prossima modalità abilitata.
ON	Porta fuori dall'Attesa
SPENTO	Porta dentro l'Attesa.
C	Inizia Taratura della Portata
IC	Inizia Taratura Interna.
AC	Abbandona la Taratura.
PSN	Stampa Numero Seriale.
PV	Versione Stampa: stampa nome, revisione software e LFT ((Legale per il Commercio) Acceso (se il LFT dovesse essere su Acceso).
x#	Imposta Conteggio APW (Peso Medio del Pezzo) (x) in grammi. (deve avere il APW memorizzato)
P#	Stampa applicazione Conteggio dell'APW.
x%	Imposta l'applicazione del peso di riferimento in Percentuale (x) in grammi. (deve avere il peso di riferimento memorizzato)
P%	Stampa l'applicazione del peso di riferimento in Percentuale.
PTIME	Stampa orario corrente.

Controllo	Funzione
PDATE	Stampa data corrente..
xTIME	Imposta Orario formato x: ora:minuti:secondi
xDATE	Imposta Data formato x: mese/giorno/anno
xS	0 = stampa data instabile, 1 = stampa solamente stabile.
xRL	Abilita o disabilita risposta OK a non-stampare i controlli: x=0 per disabilitare, x=1 per abilitare.
xT	Pre-tara il peso di contenitore (x) in grammi.

9.4.2 Collegamenti Perno RS232 (DB9)





Diagramma	Tipo	Descrizione
	Tipo d'Interfaccia	Tensione d'Interfaccia in conformità a EIA RS-232C/DIN 66020 (CCITT V24/V.28)
	Lunghezza massima del cavo	15 m
	Livello del segnale	Output: +5 V ... +15 V (RL = 3 – 7kΩ) -5 V ... -15 V (RL = 3 - 7 kΩ) Input: +3 V ... +25 V -3 V ... -25 V
	Connettore	Sub-D, 9-poli, femmina
	Modalità di funzionamento	Duplex pieno
	Modalità di trasmissione	Bit-seriale, asincrono
	Codice di trasmissione	ASCII
	Tassi di Baud	1200, 2400, 4800, 9600, 19200, 38400 (firmware selezionabile)
	Bits/parità	7-bit/pari, 7-bit/dispari, 7-bit/nessuno, 8-bit/nessuno (firmware selezionabile)
	Stop bits	Stop bit 1, 2
	Handshake	Nessuno, XON/XSPENTO, RTS/CTS (selezionabile)
	Fine della linea	Non selezionabile

10. AGGIORNAMENTI DEI SOFTWARE

Ohaus migliora continuamente i suoi software per la bilancia. Per ottenere l'ultima versione, si prega di contattare il vostro rivenditore autorizzato Ohaus oppure Ohaus Corporation.

11. CONFORMITÀ

La conformità ai seguenti standard è indicata dal marchio corrispondente sul prodotto.

Marcatura	Norme
	Il presente prodotto è conforme alle Direttive UE 2014/30/UE (CME), 2014/35/UE (LVD) e 2014/31/UE (NAWI). La Dichiarazione di Conformità UE è disponibile online all'indirizzo www.ohaus.com/ce .
	Il presente prodotto è conforma alla Direttive UE 2012/19/UE (WEEE). Si prega di smaltire questo prodotto secondo i regolamenti locali al punto di raccolta specificato per l'apparecchiatura elettrica ed elettronica. Per le istruzioni di smaltimento in Europa, si prega di fare riferimento al sito web www.ohaus.com/weee
	Questo prodotto è conforme agli standard di legge applicabili della Restrizione dell'uso di determinate sostanze pericolose nelle normative sulle apparecchiature elettriche ed elettroniche 2012, sulle normative sulla compatibilità elettromagnetica del Regno Unito 2016, sulle normative sulle apparecchiature elettriche (di sicurezza) 2016 e sulle normative 2016 sugli strumenti di pesatura non automatica. La dichiarazione di conformità è disponibile online all'indirizzo www.ohaus.com/uk-declarations .
	EN 61326-1
	CAN/CSA-C22.2 No. 61010-1 UL Std. No. 61010-1

Avviso importante per gli strumenti di pesatura verificati PX/PXP/PJX/PR....-M nell'UE e Regno Unito

Quando lo strumento viene utilizzato in commercio o in un'applicazione legalmente controllata, esso deve essere installato, verificato e sigillato in conformità alle normative locali su pesi e misure. È responsabilità dell'acquirente assicurarsi che tutti i requisiti legali pertinenti siano soddisfatti. Gli strumenti di pesatura verificati nel luogo di produzione recano quanto segue Marcatura metrologica supplementare sulla targa descrittiva.

 **MXX** 1259

 **MXX** 0126

Gli strumenti di pesatura da verificare in due fasi non hanno marcature metodologiche supplementari sulla targa descrittiva. La seconda fase della valutazione della conformità deve essere effettuata dalle autorità competenti in materia di pesi e misure.

Se le normative nazionali limitano il periodo di validità della verifica, l'utente dello strumento di pesatura deve osservare rigorosamente il periodo di nuova verifica e informare le autorità di pesi e misure.

Dal momento che i requisiti di verifica variano in base alla giurisdizione, l'acquirente deve contattare l'ufficio locale di pesi e misure se non ha familiarità con i requisiti.

Dichiarazione di conformità ISED Canada:

Questo apparecchio digitale di Classe A è conforme al ICES-003 Canadese.

Registrazione ISO 9001

Il sistema di gestione che regola la produzione di questo apparecchio è certificato ISO 9001.

GARANZIA LIMITATA

I prodotti Ohaus sono garantiti contro difetti nei materiali e nella lavorazione dalla data di consegna fino alla durata del periodo di garanzia. Durante il periodo di garanzia, Ohaus riparerà o, a sua discrezione, sostituirà gratuitamente qualsiasi componente che si dimostra difettoso, a condizione che il prodotto venga restituito, franco carico prepagato, a Ohaus.

La presente garanzia non si applica se il prodotto è stato danneggiato da un incidente o da uso improprio, esposto a materiali radioattivi o corrosivi, ha materiale estraneo che penetra all'interno del prodotto, o come risultato di servizio o modifica da personale non autorizzato da Ohaus. Invece di una scheda di registrazione della garanzia correttamente restituita, il periodo di garanzia decorrerà dalla data di spedizione al rivenditore autorizzato. Nessun'altra garanzia espressa o implicita è fornita da Ohaus Corporation. Ohaus Corporation non sarà responsabile per eventuali danni conseguenti.

Poiché la legislazione sulla garanzia varia da Stato a Stato e da Paese a Paese, contattare Ohaus o il proprio rivenditore Ohaus locale per ulteriori dettagli.



Ohaus Corporation
7 Campus Drive
Suite 310
Parsippany, NJ 07054 USA
Tel: +1 973 377 9000
Fax: +1 973 944 7177

With offices worldwide / Con oficinas en todo el mundo / Avec des bureaux partout dans le monde / Mit Büros weltweit / Con uffici in tutto il mondo
www.ohaus.com



P/N 30372570 M © 2021 Ohaus Corporation, all rights reserved / todos los derechos reservados / tous droits réservés / alle Rechte vorbehalten / tutti i diritti riservati