

OPERATING AND MAINTENANCE MANUAL

SCS



CONTENTS

1	GENERAL	3
2	INSTALLATION	4
2.A	INSTRUCTIONS AND CHECKS ON DELIVERY	4
2.B	INSTALLATION REQUIREMENTS	4
2.C	ELECTRIC/GAS CONNECTIONS AND INSTALLATION OF THE WORK SURFACE	6
2.D	POSITIONING OF THE CABINET ON THE SUPPORTING TABLE	6
2.E	SYMBOLS	7
3	OPERATION PRINCIPLES	10
4	OPERATION	11
4.A	SCOPE	11
4.B	SYSTEM AND PERFORMANCES CONTROLS	11
4.C	REMOTE SIGNALS (OPTIONAL)	12
4.D	INFLATABLE GASKET (OPTIONAL)	12
4.E	SYMBOLS OF THE CONTROL PANEL	13
4.F	MANAGEMENT AND PROGRAMMING OF RESIDUAL LIFETIME	17
4.G	DISPOSAL OF WASTES AND CONTAMINATED MATERIALS	22
4.H	ERGONOMICS	23
5	LIMITATIONS	24
6	OPERATING PROCEDURES	25
6.A	PRELIMINARY CHECKS	25
6.B	SWITCHING ON the SCS cabinet	25
6.C	SWITCHING OFF THE SCS CABINET	25
6.D	SLIDING GLASS INSTRUCTIONS	26
7	MAINTENANCE	27
7.A	INSTRUCTIONS FOR DAILY CLEANING OF BIOSAFETY CABINETS (by users)	27
7.B	CLEANING OF GLASS	28
7.C	INSTRUCTIONS FOR THE FUMIGATION/STERILIZATION OF BIOLOGIC SAFETY CABINETS	28
7.D	REPLACEMENT OF HEPA FILTERS (by technical assistance personnel)	31
7.E	REPLACEMENT OF MOTOR-FANS (by technical assistance personnel)	35
7.F	REPLACEMENT OF FLUORESCENT LAMPS (by technical assistance personnel)	37
7.G	REPLACEMENT OF U.V. GERMICIDE LAMP (by technical assistance personnel)	37
7.H	SPARE PARTS LIST	38
8	MONITORING SYSTEM	40
9	TROUBLESHOOTING - Probable causes of malfunctions	41
10	TRANSPORT, PACKING and STORAGE INSTRUCTIONS	42
11	ADDITIONAL INFORMATION	45
11.A	GUARANTEE	45
11.B	ADDRESS FOR TECHNICAL ASSISTANCE (for the distributor)	45
12	TESTS PERFORMED ACCORDING TO EN 12469 STANDARD	46
12.A	MEASUREMENT OF LAMINAR AIRFLOW VELOCITY	46
12.B	MEASUREMENT OF THE EXHAUST AIR VELOCITY	47
12.C	MEASUREMENT OF THE NOISE LEVEL	47
12.D	MEASUREMENT OF LIGHTING	47
12.E	MEASUREMENT OF VIBRATION	47
12.F	CONTROL OF ALARMS	48
12.G	D.O.P TEST FOR MAIN AND EXHAUST HEPA FILTER	49
12.H	INSTRUCTIONS FOR THE CLEANING TEST OF BIOLOGICAL SAFETY CABINETS	50
12.I	EVALUATION OF PROTECTION FACTORS	51
13	DRAWINGS AND DIAGRAMS	54
13.A	DIAGRAM FOR MAINTENANCE OPERATIONS	55
13.B	FRONTAL DIAGRAM	57
13.C	SIDE DIAGRAM	58
14	ASSEMBLY of SUPPORT TABLE	59
15	ASSEMBY OF THE CABINET ON THE SUPPORTING STAND	60
16	SAFE WORKING AREA DIAGRAM	62
17	SENSORS LIST	64
18	WIRING DIAGRAM	65
18.A	SCS 3 – 4 (230V 50Hz)	65
18.B	SCS 5 – 6 (230V 50Hz)	69
18.C	SCS (110V 60Hz)	74
19	DECLARATION OF CONFORMITY	78

1 GENERAL

Class II Biological Safety cabinets with partial exhaust and protection barrier, the SCS cabinets, are designed to protect both the material to be manipulated from contamination and to protect the operator and the environment from microbial contamination hazards.

The dusted, filtered and sterile air passing through the main HEPA filter ensures optimum airflow laminarity on the work surface, thanks to its even perforation and the frontal air barrier. The system is designed to create a protective barrier and prevent exchanges between the internal, potentially biologically contaminated air, and the outside.

SCS cabinets are Class II Biohazard cabinets, according to the definitions now adopted by all the main international standards (example: EN 12469:2000) Suitable for the treatment of class CDC-2/3, DHSS-B2/B1 micro-organisms, group 1,2,3 decree no. 626 "Safety in the work environments" and wherever a product-personnel-environment cross-protection is required.

Especially suitable for applications such as:

- Manipulation of eziologic agents having a known pathogenicity on humans and animals.

Presence of high concentrations of biologic materials.

Presence of agents likely to cause genetic alterations or synergetic activities with other materials.

Oncogenic viruses.

Do not manipulate the products on the slotted part at the entry of the chamber, but in the middle of the work surface.

The performances of the cabinets are detailed in the TESTING CERTIFICATE below, in compliance with the requirements of:

- EN 12469 (2000)

Furthermore SCS cabinets fulfil the armonized standards EN 61010-1 as well as EN 61326 according to the applicable European directives regarding the CE marking.

SCS cabinets comply with the above-mentioned standards ONLY if the instruments connected to the electrical socket positioned inside the work chamber are "CE" marked or in any case it meets the above mentioned standards aiming to avoid any electromagnetic interference.

All cabinets are provided with high insertion loss filters.

Cabinets can be supplied:

with supporting table. For stability reasons the instructions in the present manual must be followed, in particular please see paragraph 4B. (SYSTEM and PERFORMANCES CONTROLS) and paragraph 5 (LIMITATIONS).-

without supporting table. In that case the customer must put the cabinet on a table or a supporting surface suitable to assure its stability in all operating conditions, complying with all safety regulations presently in force.

The company cannot be held responsible for malfunctions, damage to people or property due to non-compliance, poor or no maintenance, or improper use of the cabinet.

2 INSTALLATION

2.A INSTRUCTIONS AND CHECKS ON DELIVERY

Considering the critical nature of the use of the SCS cabinet and the need to keep it in optimum condition, installation is very important.

SCS Biohazard cabinets are positioned on a pallet, wrapped in an extensible film and contained in a package of multi-layer strapped cardboard.

After placing the cabinet in its site of use, opened the package and removed the extensible film, check that the equipment has not suffered any dents or scratches due to transport or improper handling of the package.

In case of any further transport, packing and storage by the user after the initial period of use (e.g.: change of laboratory or factory), contact the technical assistance service or the distributor for more accurate and precise instructions or for assistance by specialized technicians.

SCS Biohazard cabinets, with or without package, should be always located in a room sheltered from rain.

2.B INSTALLATION REQUIREMENTS

Install the cabinet away from drafts and heat sources (radiators, ventilators/convectors), to ensure proper functioning. For instance, in a small room (<30 m³), if an exhaust duct is used to expel air outside the building, we recommend the installation of a grill in the room in order to provide an air supply equal at least to the quantity entering the front of the cabinet to create the protective barrier.

- Install the cabinet in a well-ventilated room with a low degree of dust.
- The distance between the cabinet and the exhaust system (if present) should be as short as possible.
- Place the cabinet away from doors and windows, which may cause malfunctions
- Place the cabinet in places where there is little human traffic.
- The exhaust system should be installed on the roof or on a wall or through a window. Otherwise, it can be connected to a chimney.
- The door of the room should be in such a position relative to the cabinet as to prevent drafts.
 - o Min. temperature: 5 °C
 - o Max. temperature: 40 °C
 - o Max. humidity: 80% at 31°C, linear drop in relative humidity down to 50% relative humidity at 40°C.
 - o Pollution degree: II

The exhaust duct (optional), located on top of the cabinet, should be connected to the outside of the building, in which case an anti-blowback shutter (code F72 799510) should also be installed on the exhaust flange, as recommended by EN 12469.

Alternatively it is possible the connection with the conditioning plant, but the air must not be recycled.

If the cabinet is equipped with the exhaust motor fan it is possible connect this to a smooth channel with the following features: diameter of 200mm and maximum length of 100 linear meters. The single-fan cabinet can be canalized only with remote motor-fan and thought thimble connection (optional). Otherwise some changes must be made in the extraction fan or a remote exhaust motor-fan must be installed. In both cases the anti-blowback system and/or a thimble connection prevent air from flowing back into the extraction channel.

Before connecting the cabinet to the mains power supply, check the necessary voltage and power indicated on the plate near the power cable. The room must be equipped with an earth connection and connections to the gas and/or vacuum networks, and an air exhaust duct must be installed outside the building.

Thimble method example

LEGENDA:

1. Exhaust air from the cabinet.
2. Air from the environment.
3. Bleed Air (100÷200 m³/h more than the exhaust air flow rate from the cabinet) to a dedicated exhaust fan (in the electronic board a voltage free contact is available –see electrical diagram- to check when ventilation is ON).

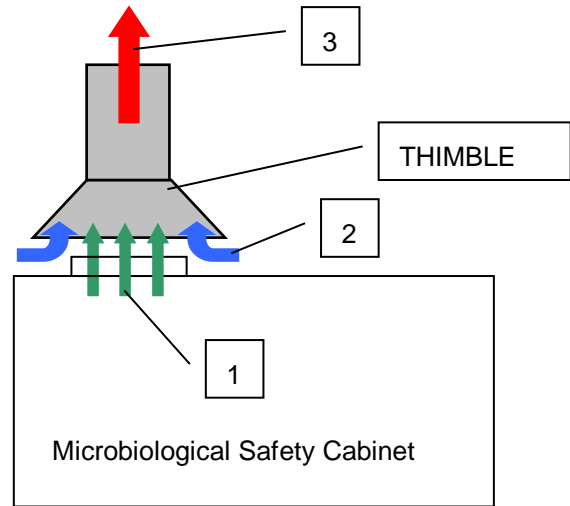

For the connection to the gas and/or vacuum networks, read carefully chapter 2C.

The quantity of heat generated by the cabinet, if the air is not extracted outside the room, is the following for the eight models respectively:

SCS 1-3	400 kcal/h	SCS 2-3	410 kcal/h
SCS 1-4	450 kcal/h	SCS 1-4	460 kcal/h
SCS 1-5	500 kcal/h	SCS 2-5	520 kcal/h
SCS 1-6	520 kcal/h	SCS 2-6	540 kcal/h

This heat value must be added to the heat generated by any instrument (eg. connected to internal socket or tap) used by the client in the work chamber.

ATTENTION: the installation must be done by technicians authorized or by the official distributor.

2.C ELECTRIC/GAS CONNECTIONS AND INSTALLATION OF THE WORK SURFACE

The electrical connection of the SCS Biohazard cabinet is made by connecting the power cable located on the upper of the right side of the cabinet to a suitable power point (see technical table) . When the cabinet is connected, the green light on the control panel switches on..

When the cabinet is connected to the main supply it is compulsory to position the cabinet in order to reach and disconnect the plug easily when needed, for example avoid to plug the cabinet using a socket positioned behind the cabinet itself.

If stipulated by local legislation, insert upstream of the power line an automatic protection overload switch provided with a differential relay, with a rated switching voltage no greater than 30 mA.

NOTE: regarding the electrical connection is necessary to use the cable supplied with the cabinet or a suitable cable that can provide a 10A current.

The right side of the cabinet is can also be provided with two gas/vacuum intakes with manual taps one of which is fitted with an electrovalve.

The size of the pipes for the gas connection is: 1/4"

The connection with the two gas/vacuum intakes is made according to the type of connection: town gas or industrial gas (air, vacuum, nitrogen, etc.).

The cabinet must be connected by qualified staff to the town gas mains through an approved conduit for safety reasons.;

NOTE: the gas that can be used with the standard tap configuration is methane, for other gas type it is necessary change the tap model.

NOTE: No part of the cabinet is involved in explosion and/or burns/flames. Flammable gas is used (if it is) by the customer under their own responsibility. Anyway the fuel gas is blocked by a solenoid valve in case the air velocity is lower than the safety condition. E.g. the gas valve cannot be open if the safe air velocity is not reached or in any case of air flow alarm.

For the installation of the work surface, proceed as follows:



- remove the protective paper from the work surface leant against the back of the cabinet, taking care not to scratch its surface,
- open the safety front window,
- clean the work surface with a damp cloth soaked in alcohol or soapy water or with a commonly available product designed for stainless steel,
- place the work surface into the work chamber, let the back to slide on the chamber's supporting bases up to its back wall,
- close the safety front window.

2.D POSITIONING OF THE CABINET ON THE SUPPORTING TABLE

SCS-1/2 Microbiological Safety Cabinets can be supplied with the relevant supporting table, which they have to be fixed to.

After assembling the supporting table (see instructions at para. 15) put the supporting table on a flat not sloping floor and be sure that all the parts of the cabinet, that can be opened (control board panel and sash) are locked. Then position the cabinet on the table (See instructions at para. 16).

2.E SYMBOLS

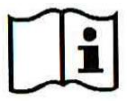
	Caution! Read the documents enclosed to the machine.
	Electric risk
	Contamination risk
	Read the instruction

Technical Features Table

Description	Unit of measure	SCS 1/2 - 3	SCS 1/2 - 4	SCS 1/2 - 5	SCS 1/2 - 6
Overall Dimensions (W x H x P(*))	mm	1045x1500x860	1350x1500x860	1655x1500x860	1960x1500x860
Usefull dimensions (W x H x P)	mm	887x740x580	1192x740x580	1497x740x580	1802x740x580
Maximum front aperture	mm	440			
Working aperture	mm	200			
Weigh	Kg	170	195	225	260
Noise level	dB (A)	<53	<54	<55	58.4
Lighting level	Lux	>1000			
Nitrogen, CO ₂ , compressed air - maximum pressure	bar	4			
Fuel gas- maximum pressure	mbar	20			
Main voltage	V	230V AC 2P+T			
Frequency	Hz	50			
Power (S version)	W	1200	1310	1510	1610
Current	A	5,76	6,07	7,49	7.83
Power (D version)	W	1260	1370	1540	1750
Current	A	6.27	6.52	7.92	8,52
Electrical class		1			
Protection level		IP20			
Internal outlet (maximum current for all the sockets: 4A)		2P+T 230V 4A			
Fluorescent lamps	W	2x30	2x36	2x58	2x58

(*) Overall depth can be reduced to 795 mm removing the back external panel

Power card

Tag	Description	Rating
F1	Auxiliary supply	3.15 AT
F2	U.V. light fuse	1 A
F3	Light fuse	2 A
F4	Socket fuse – phase	4 A
F5	Socket fuse – neutral	4 A
F6	Exhaust motor fuse	6.3 AT
F7	LAF motor fuse	10 AT
F8	Electric valve fuse	1.6 A

Fuses List

3 OPERATION PRINCIPLES

The following are the working principles of the SCS Biohazard cabinets.

The pressurized air pushed into the plenum of the main motor-fan passes through the absolute filter and then downwards, in a laminar flow, into the working chamber.(A). From here, through the perforated surface, having mixed with the external air (B) which enters the cabinet from the front opening, it is sucked into the intake up channel situated at the rear and side of the work chamber (C). Part of the air is exhausted (D) through the exhaust HEPA filter. This extracted air let air come in from the outside (front barrier) ensuring the protection of the operator/environment from hazardous material manipulated in the work area.

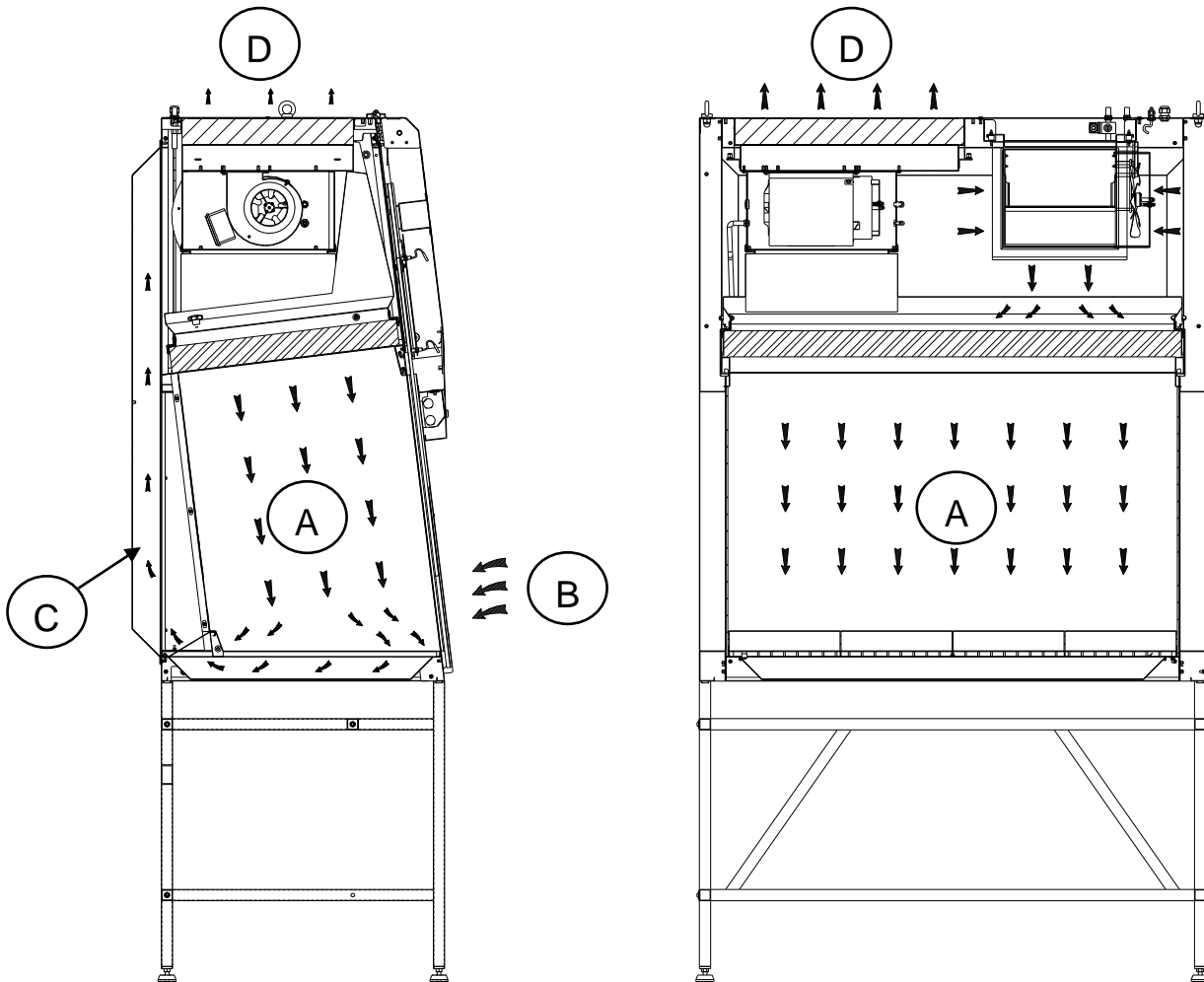

4 OPERATION

4.A SCOPE

The biosafety cabinet SCS is manufactured in compliance with international standards for the protection of the material, the operator and the environment against biological hazards of Class II and is suitable for the manipulation of low- and middle- risk pathogenic agents (CDC-2/3, DHSS- B2/B1, NSF-1/2/3, D.L no. 626 group 1,2,3).

SCS cabinets are designed in compliance with the following standard:

- EN 12469 (2000) Microbiological Safety cabinets

4.B SYSTEM AND PERFORMANCES CONTROLS

The SCS cabinet is provided with an automatic regulation system to keep the airflow speed in the work chamber and the recycling air/extracted air ratio constant even with the progressive clogging of the two HEPA filters up to the maximum pressure supported by the motor-fan.

The soft-touch control panel is microprocessor-controlled with a display showing all relevant data with regard to the operating functions, the different alarms and the error messages.

The perforated work surface creates optimal airflow laminarity at working level, while the front longitudinal slots create a protective air- barrier.

The vertically sliding safety glass sash is electrically operated. When the cabinet is running the work opening must be 200mm; any moving of the glass activates an audible and visual alarm, which cannot be silenced according to the EN 12469 standard.

When the cabinet is off the glass can be either opened up to the maximum opening or closed completely.

The front sash window can be closed and opened by pressing alternatively one of the two keys “arrow-up and arrow-down” [8] – and the red safety key on the right (see paragraph 4E)

The further red key [16] is a safety measure for the operator, because the moving of the glass from the work position is possible only if this key and one of the other two keys (arrow-up and arrow-down) are pressed at the same time.

When the cabinet is on, any change of the work aperture invalidates the efficiency of the air barrier protecting the operator, therefore if the operator presses the two keys at the same time he is perfectly aware of the potential risk he is running

Furthermore a safety device is installed, which stops the motor-fans automatically when the cabinet is on and the electrically operated sash window is completely closed.

To optimize the visibility inside the work chamber, the cabinet is ergonomically angled sloping-fronted (abt. 7 degrees sloping as to the vertical).

The CPU card is provided of a backup battery for the maintaining of the cabinet timer when a blackout occurs. The battery model is: CR2032 3V

4.C REMOTE SIGNALS (OPTIONAL)

The electronic control board can be improved adding the following optional features:

Ventilation status (ON/OFF)

It is possible to obtain a 12 Vdc output to connect a led light or alternatively a Normally Open voltage free contact to be connected to an external circuit.

There are two different working possibilities:

- 1 the signal starts when ventilation is turned ON and stops when ventilation is OFF.
- 2 the signal is flashing during the start up phase of the ventilation and is ON when the correct air flow conditions are reached.

Correct air flow conditions

It is possible to obtain a 12 Vdc output to connect a led light or alternatively a Normally Open voltage free contact to be connected to an external circuit. That signal is closed when air flow rate is in the correct range and it is open in case of any flow alarm.

External consent

On request it is possible to allow ventilation to be turned ON by a remote volt free contact. When the ventilation is turned ON the cabinet stay in stand by (start up) till the remote normally open contact is closed.

If during normal ventilation the remote contact is open the following message will appear "REMOTE CONTACT OFF" and the operator has to switch OFF ventilation as soon as possible and then check the reasons of the failure.

4.D INFLATABLE GASKET (OPTIONAL)

The optional inflatable gasket can be used to improve the sealing of the front glass during normal working phase or during the sterilization of the unit.

The cabinet is supplied with a plastic pipe to be connected to compressed air line (at customer charge) or to a compressor (available as option on request).

The gasket can be inflated only when the front glass is in working position or in completely closed position.

To inflate and deflate the gasket the "SET" [10] and "GLASS SAFETY" [16] keys have to be pressed at the same time.

Since the gasket will be pressed against the front glass, in that case it is not allowed to move the glass and the message "DEFLATE GASKET" will appear.

If the gasket is deflated, after 5 seconds, a pressure sensor will allow the front glass to be moved again.

In case the control panel is opened and the glass is moved, the gasket will deflate immediately if it is inflated

The pneumatic circuit of the gasket is fitted with pressure switch in order to check the correct operation of it.

In case of a pressure loss the alarm message "CHECK THE GASKET" will alert the operator.

4.E SYMBOLS OF THE CONTROL PANEL

List and description of all the symbols and controls of the control panel:

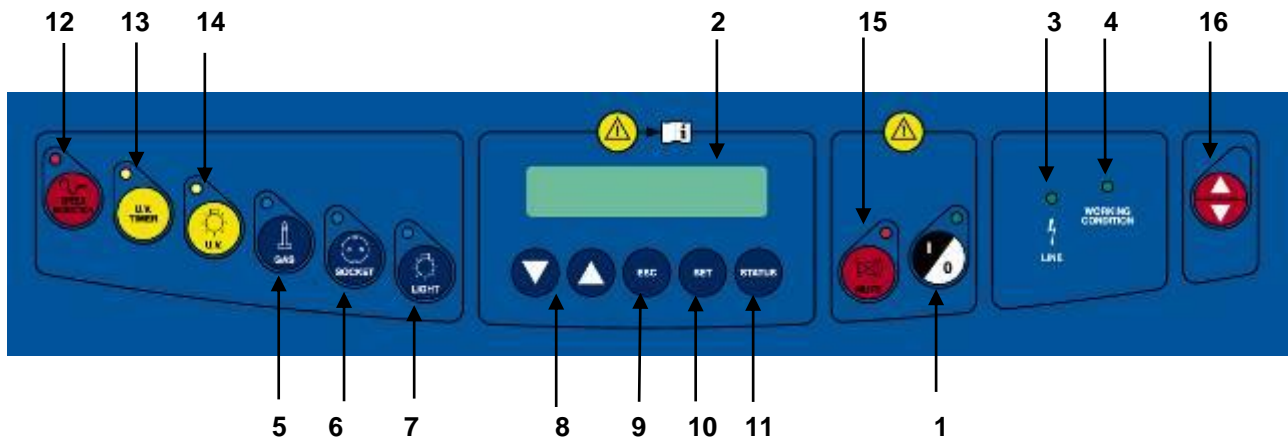

1 MAIN SWITCH:

Position "0"

in the "0" position, the green light of the mains voltage is on (3); the LCD displays the model name "SCS". In this position the operator can activate only the fluorescent light (7), the U.V. lamp (14) and the power outlet (6) (with plug installed) and can activate the data stored in the microprocessor by pressing the "STATUS" key (2).

Position "I"

by pressing "I" the password to enter is requested. When the password is typed in (press arrow-up key (▲) 5 times, arrow-down key (▼) 4 times and press SET) the green led of the switch lights up and the cabinet starts operating, LAF and exhaust (if installed) motor-blowers are powered and first "CHECK PANEL" then "STAND-BY" appears on the display. The LCD shows the required time (about 40 seconds) for the laminar flow and the exhaust velocity to reach the pre-set values. In addition, an audible alarm will sound intermittently during this stand-by period, alerting the operator not to start working yet. When the audible alarm stops and the message "STAND-BY" disappears from the display, the cabinet is ready for use.. The LAF and face barrier air velocities are displayed.

NOTE: In any case, it is advisable to wait 20-30 minutes before starting work.

2 DISPLAY

Rearlit liquid crystal "LCD" display composed of 2 lines of 20 characters each showing the operating parameters and alarms.

3 LINE

The green mains light switches on if the unit is connected to the mains and the line is live

4 WORKING CONDITION

The green LED lights up when the ventilation works correctly.

5 GAS

This activates the control for opening/closing the gas electrovalve; when enabled, the display shows "GAS ON". It operates only when the cabinet is running to prevent possible over-heating and risks of damaging the HEPA filter.

6 SOCKET

This supplies voltage; when enabled, the display shows "POWER ON".

7 LIGHT

This switches on the fluorescent light; when enabled, the display shows "Light on". Switching on the fluorescent light automatically the U.V. lamp switches off.

8 UP/DOWN ARROWS

Use the arrow keys to scroll the menu, to program changing parameters and to put in the password. Three passwords are programmed: 1) to start the cabinet – 2) to enter the operator menu – 3) to enter the main menu to change the data input (allowed only to authorized technical staff – service – because unsuitable interventions can cause troubles and incorrect operation of the cabinet

9 ESC

ESC key deletes the operation of data input and goes back to the starting condition.

10 SET

SET key lets you enter the different functions or confirm the data input going back to the upper level.

11 STATUS

If pressed in sequence, the following data will appear on the display:

External Temperature: Shows the temperature outside of the cabinet; the LCD will display (for example) "EXT. TEMPERATURE=27°C" This value is taken by an electron probe installed outside the cabinet.

Internal Temperature: Shows the internal temperature of the cabinet work area; the LCD will display (for example) "INT. TEMPERATURE =30°C" . This value is taken by an electron probe located inside the cabinet.

U.V. Lamp Residual Lifetime: Shows the operating time of the U.V.lamp pre-set by the user with the appropriate keys. The LCD will display (for example) "U.V. TIME=XXXX h" . When such time is over, the message "U.V. LIFETIME OVER" will appear on the line below.

1, 2, 3, 4, 5 **Residual lifetime of filters** : it is the operation time of the filters installed in the cabinet that can be programmed by the user.

The LCD will display (for example)" RES. TIME FILTER 1=XXXX:XX h:min". When such time is over, the message "CHECK FILTER (es.) 1". will appear on the line below.

The filters installed in the cabinet follow the numbering listed below

TYPE of FILTER	NUMBER
MAIN DOWNFLOW HEPA	1
FIRST EXH. HEPA	2
SECOND EXH. HEPA	3
CHARCOAL FILTER	4

LAF Power: it is shown indirectly by the power supply voltage of the main motor, expressed as percentage of max. load voltage displayed also in proportion by a bar.

The display shows the notice(es.): "MOT.LAF = XX % " (max.100%).

BAR Power: it is shown indirectly by the power supply voltage of the exhaust motor, expressed as percentage of max. load voltage displayed also in proportion by a bar.

The display shows the notice(es.): "MOT.EXH = XX % " (max.100%).

Operating Time: Shows the operating time of the cabinet from the moment when the main switch is positioned on "I"
The LCD will display (for example) "WORK TIME=XXXXXh". This value cannot be reset.

12 SPEED REDUCTION

By pushing the corresponding red key the password (the same of start) is requested. Once confirmed the password the function is enabled. When it is enabled, the corresponding red LED lights up and, for single fan cabinets, the LAF and exhaust speeds are about 30% lower than their nominal speeds; for double fan cabinets, the only exhaust speed is about 30% lower than their nominal speed. The light and the gas electrovalve cannot be switched on. If they are on, they switch off automatically. The following two messages appear alternatively:

**>>>ATTENTION<<<
DANGER**

and:

**REDUCED AIRFLOW
>>>DO NOT WORK<<<**

The "SPEED REDUCTION" function can be enabled only with the main switch in position "I". Only the power supply (3) can be operating.

13 U.V. TIMER

This concerns the yellow key for the timed management of the U.V. lamp (with timer). When the front sash window is completely down, by pushing the relevant key, you are requested to set the time. The timer resolution is 1 minute and the maximum time is 180 minutes (3 hours). The display will show the latest pre-set value, which can be changed using the "arrow" keys; when the time has been set, press the "SET" key to confirm. At this point the yellow LED lights up, the U.V. lamp is activated and the countdown starts. During the cycle the following message appears:

**U.V. TIMER
U.V. Timer (min) xxxx**

where "xxxx" is the time in minutes before the automatic stopping of the U.V. lamp. When the time reaches zero, the U.V. lamp is disabled and a brief audible warning signal is activated. To cut off the cycle press the "U.V. TIMER" key again.

If during the cycle there is a blackout, the timer is set again, the U.V. lamp is activated again and the countdown starts again. The U.V. lamp is activated only when the lighting is off. If the lighting is activated when the U.V. TIMER is on, the U.V. lamp switches off. Also the starting up of the cabinet cuts off the cycle and switches off the U.V. lamp.

14 U.V.

Yellow key to switch on UV lamp with non programmable timer. This supplies the U.V. lamp in "manual" mode; when enabled, the display shows "U.V. on". The U.V. lamp switches on only if the cabinet is off, the lighting of the cabinet is off and the front sash window is completely closed. After 180 minutes the U.V. lamp switches off automatically.

N.B.

When UV is on the front glass cannot be raised

15 MUTE

The red alarm LED lights up when an alarm condition occurs, which is shown also by the message appearing on the LCD. By pushing "MUTE" the alarm stops sounding (if enabled).

16 UP/DOWN ARROWS

Red safety button, working only in cabinets fitted with electrically operated, vertically sliding sash

4.F MANAGEMENT AND PROGRAMMING OF RESIDUAL LIFETIME

Get access to operator menu when the cabinet is in stand-by pressing “ESC” [9] together with “UP arrow” [8] keys (password).

The following diagram shows the organization of “OPERATOR MENU”

By pressing “SET” [10] you can either go to the highlighted entry or confirm data entry while by pressing “ESC” [9] you go back to the beginning

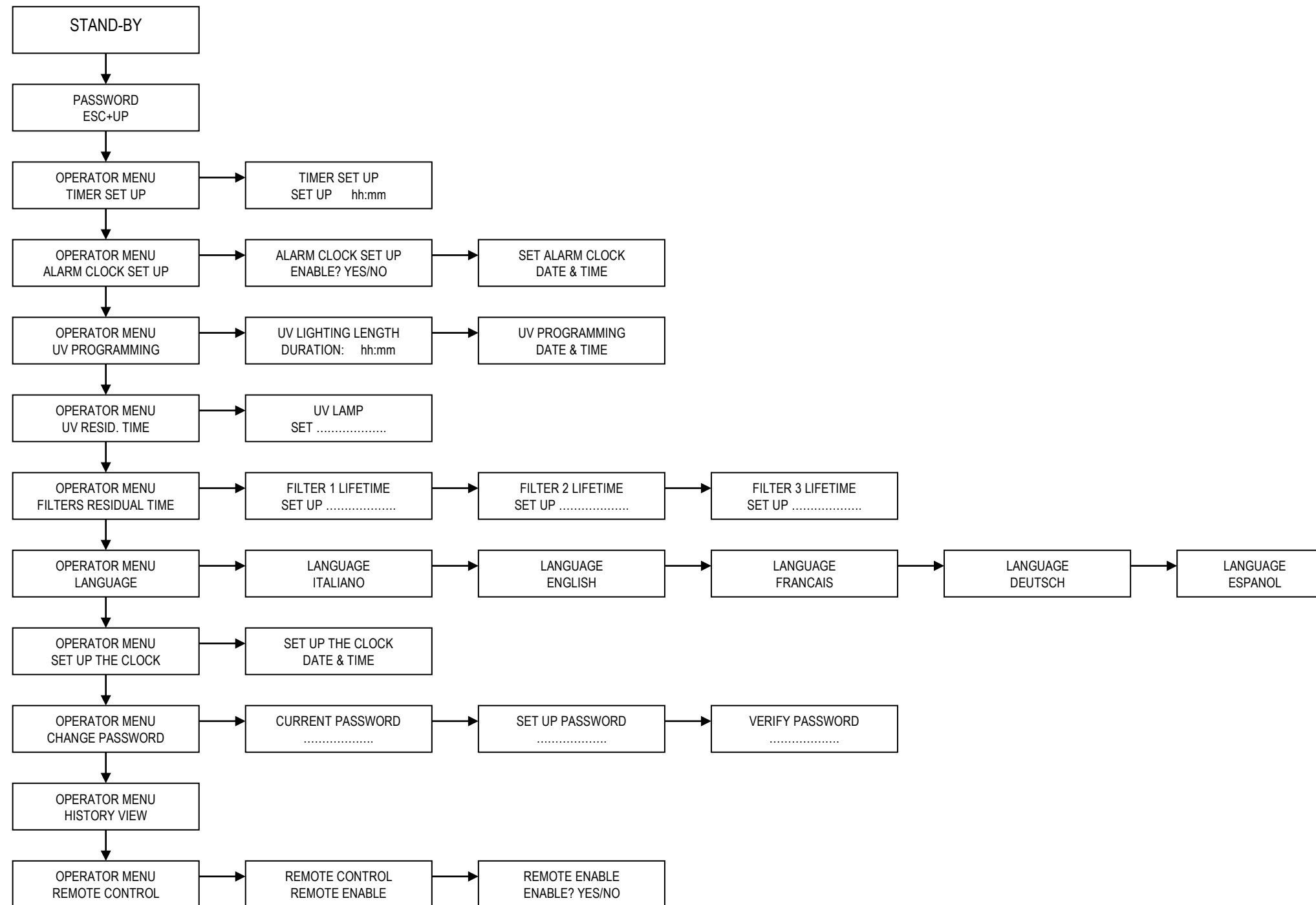

TIMER (countdown):

- use "UP/DOWN arrow" keys [8] to scroll the operator menu
- select "TIMER SET UP." and press "SET" [10] key; the display will show:

TIMER SET UP
SET UP hh:mm

- input the desired time and press SET [10] to confirm
- press ESC to exit the operator menu
- the display will show alternatively the countdown and the standard information
- when the countdown finish an audible signal will advise the operator. It is possible silence the signal with the ESC key

To disable the countdown:

- select "TIMER SET UP" and press "SET" [10]; the display shows:

TIMER SET UP
RESET? YES

- press "SET" [10] to confirm
- press "ESC" [9] to exit the operator menu.

ALARM CLOCK:

- use "UP/DOWN arrow" keys [8] to scroll the operator menu
- select "ALARM CLOCK SET UP" and press "SET" [10]; the display shows:

ALARM CLOCK SET UP
ENABLE? YES

- press SET [10] to confirm and the display shows:

. ALARM CLOCK SET UP
DATE & TIME

- set the date and the time with the arrow keys and confirm pressing SET; when the time previously set is reached and audible signal will advise the operator. Is possible silence the signal with the ESC key.

To disable this function:

- select "ALARM CLOCK SET UP" and press "SET" [10]; the display shows:

ALARM CLOCK SET UP
ENABLE? NO

- disable the alarm clock choosing "NO" and press "SET" [10] to confirm
- press "ESC" [9] to exit the operator menu.

UV PROGRAMMING:

- use "UP/DOWN arrow" keys [8] to scroll the operator menu
- select "UV PROGRAMMING" press "SET" [10]; and the display shows:

UV LIGHTING LENGTH SET UP hh:mm

- input the desired time for the UV cycle and press SET [10] to confirm
- the display shows:

.UV PROGRAMMING DATE & TIME

- set date and time with the arrow keys and confirm pressing SET. when the time previously set is reached the UV lamp switches ON, if the requirements to switch ON the UV lamp are not satisfied (e.g.: glass open) an alarm message will be displayed.
- press "ESC" [9] to exit the operator menu.

U.V. LAMP RESIDUAL LIFETIME:

- use "UP/DOWN arrow" keys [8] to scroll the operator menu
- select "U.V. LAMP RESIDUAL LIFETIME." and press "SET" [10] key; the display will show:

U.V. LAMP RESIDUAL LIFETIME set XXXX

- where XXXX shows the number of the hours set for lifetime of the U.V. lamp.
- Use the "up and down arrow" keys to adjust the hours parameter
- Then press the "SET" key [10] to confirm the data and/or go back to previous menu
- To conclude programming, press ESC" [9] key.

FILTERS RESIDUAL LIFETIME:

- use "UP/DOWN arrow" keys [8] to scroll the operator menu
- select "FILTERS RESIDUAL LIFETIME." and press "SET" [10] key; the display will show:

FILTER 1 RESIDUAL LIFETIME set XXXX

where XXXX shows the number of the hours set for lifetime of the FILTER 1

- Use the "up and down arrow" keys to adjust the hours parameter
- Then press the "SET" key [10] to confirm the data and pass to filter 2 and so on up to filter 5
- To conclude programming, press ESC" [9] key.

LANGUAGE SELECTION

- use "UP/DOWN arrow" keys [8] to scroll the operator menu
- select "LANGUAGE" and press "SET" [10] key; the display will show:

LANGUAGE

English

- With the "up and down arrow" keys select the desired language (Italian, English, French, German, Spanish). Press the "SET" key to confirm and exit the "LANGUAGE" menu.
- Press the "SET" key to exit the Operator Menu and return to the standard display.
- press "ESC" [9] key to go out.

SET UP THE CLOCK

- use "UP/DOWN arrow" keys [8] to scroll the operator menu
- select "SET UP THE CLOCK." and press "SET" [10] key; the display will show:

SET UP THE CLOCK

set XXXX

- Use the "up and down arrow" keys to change the hours, minutes, days, month, year, weekday
- Then press the "SET" key [10] to confirm the data and/or go back to previous menu
- To conclude programming, press ESC" [9] key.

PASSWORD CHANGE

- use "UP/DOWN arrow" keys [8] to scroll the operator menu
- select "CHANGE PASSWORD" and press "SET" [10] key; the display will show:

CURRENT PASSWORD

PSW:

- digit the present Password then press "SET" key

SET UP PASSWORD

PSW:

- digit the new Password then press "SET" key

CHECK PASSWORD

PSW:

- digit the password again and then press "SET" key to confirm the data and/or go back to previous menu
- To conclude programming, press ESC" [9] key.

DISPLAY OF HISTORICAL FILES

- use "UP/DOWN arrow" keys [8] to scroll the operator menu
- select "HISTORY VIEW" and press "SET" [10] key; the display will show:
- use "UP/DOWN arrow" keys to scroll through the list of the possible troubles happened . The list is in chronological order and contains up to 64 voices
- To conclude programming, press "ESC" [9] key.

REMOTE CONTROL

- use "UP/DOWN arrow" keys [8] to scroll the operator menu
- select "REMOTE CONTROL" and press "SET" [10] key; the display will show:

**REMOTE CONTROL
REMOTE ENABLE**

- press again SET and the display shows the following message:

**REMOTE ENABLE
ENABLE? YES/NO**

- Choose the desired option and press SET
- press "ESC" [9] to exit the operator menu.

4.G DISPOSAL OF WASTES AND CONTAMINATED MATERIALS

DISPOSAL OF ELECTRIC AND ELETTRONIC DEVICES (AEE)



INFORMATION FOR EUROPEAN UNION USER

This symbol on the device means that when it needs to be disposed, it must be handled separately from urban waste.

At the moment of the disposal, contact the dealer, to receive information about the collect and disposal in accordance with the laws in force in the country.

Appropriate disposal of this product will help to prevent potential negative effects on health and environment and to promotes re-use and / or recycling of materials of the equipment.

The improper disposal of the product by holder involves the application of sanctions in accordance with the regulations in their own country.

INFORMATION FOR USERS OUTSIDE THE EUROPEAN UNION

This symbol is valid only in the European Union If you want to dispose this product, contact your local authorities or dealer and ask for the correct method of disposal.

ATTENTION: Before disposal, the cabinet where contaminants and pathogens have been manipulated, must be sterilized

The fluids of pathogenic material removed from the work surface and the liquid collection tank located under the table as well as from the HEPA absolute filters replaced during maintenance work are biologically toxic and harmful and must be submitted to special treatment. For more detailed information on such treatment, see the standards and regulations in force on the treatment and disposal of biologically toxic/harmful wastes.

All other materials, which the cabinet is made, are recyclable but cannot be disposed as local waste materials.

MATERIALS, WHICH THE CABINET IS MADE OF

PARTS OF THE CABINET	MATERIALS
External structure	Epoxy powder painter steel
Inside work chamber	AISI 304 stainless steel
Work surface	AISI 316L stainless steel
Motor-fans	Galvanized steel
Filters	Frame: in aluminium alloy Filtration bed: glass fibre Protection: Fe net/epoxy powder painted Gasket: polyurethane
Keyboard	PE, graphite, circuits in materials compatible with Rohs regulations
Front and side glasses	Stratified soda-calcic silicate sheet
Gaskets	Neoprene
Wirings	Wires according to Rohs regulations, flame-proof cases in PVC
Cablepress	Body/nut in polyamide, inside part in neoprene

4.H ERGONOMICS

This Microbiological safety cabinet has been designed and manufactured according to the general directions on the ergonomics provided for by the EN ISO 14738 standard.

Furthermore all maintenance operations are assured to be carried out in safety by merely following the instructions given in this manual at chapter 7.

5 LIMITATIONS

PRECAUTIONS for the correct use of the cabinet

Listed below are the most important guidelines to be followed and the main substances to be avoided to ensure the correct use of the SCS cabinet:

NEVER USE chlorine-based substances (e.g. sodium hypochlorite) as they are corrosive for the metal structure of the cabinet, and in particular for stainless steel parts.

When the nature of the work carried out under the cabinet changes completely or following an accidental spilling of pathogenic material, STOP working and start again only after having cleaned and sterilized the cabinet,

DO NOT use ethanol as a sterilizing substance if a heat source is used under the cabinet,

DO NOT use cosmetic powders, nail polish, hairspray or cosmetics in general during work,

DO NOT eat, drink or smoke in the work zone,

AVOID substances that release explosive vapours.

In addition, when working with the cabinet, AVOID:

the introduction of extraneous material

the introduction of paper or cloth that might clog the holes of the work surface

working in the part of the work surface near the front opening of the cabinet (longitudinally slotted zone)

upstream contamination of the material, putting the hands or any object between the absolute filter and the sterile material

working under the cabinet if the airflow has not yet been activated, i.e. when the display "STAND-BY" appears, indicating that the motor-fans are not yet on. After the cabinet is switched on, and if the work requires special sterile conditions, chemical sterilization of the work chamber must be carried out using a cloth soaked in bactericide. Then wait for 20-30 minutes for the bactericide to take effect.

using in the work zone large-size bunsen burners, as the flame might damage the absolute filter located in the upper part of the working area

manipulating pathogenic material not included in the categories indicated for Biohazard cabinets Class II according to EN-12469.

Before opening the front window be sure that the inside of the cabinet has been properly decontaminated; in fact this part can be potentially dangerous for the operator's hands as well as for the laboratory air, which comes directly into contact with, after opening the front window.

ATTENTION: the U.V. radiations emitted by the germicidal U.V. lamp can cause erythemas and conjunctivitis. Avoid exposure of skin and eyes to direct radiation

6 OPERATING PROCEDURES

6.A PRELIMINARY CHECKS

Before carrying out any type of work, the following conditions should be verified:

- that the cabinet power cable is connected to a power point at a suitable voltage and frequency as per instructions shown on the label stuck near the electric cable
- that all alarm lights are off
- that the work area inside the cabinet is free from materials used during the previous session.
- that the cabinet has been sterilized in case of change in the nature of work to be carried out

6.B SWITCHING ON the SCS cabinet

To start the cabinet, proceed as indicated below:

1. turn on the light by pushing the blue button [7] (If the UV lamp [14] is on, it switches off)
2. be sure that the sash window is in the work standard position (see para. 4B.)
3. press the main key I/O [1] (see chapter 4C.) and enter the password to switch on the cabinet. At first the display shows "CHECK PANEL" and the corresponding control leds of the keyboard light up. Then the message "STAND-BY" is displayed for about 40 seconds and the hour-counter starts operating
4. after 40 seconds of stand-by, the cabinet is ready for work. "STAND-BY" disappears from the screen and the LAF and protection barrier velocities are displayed
5. wait for 20-30 minutes before starting work
6. during this period of time, introduce into the internal work zone of the cabinet only the materials which are indispensable for the job at hand.

All movements made under the laminar air-flow cabinet should be parallel to the work surface, taking care to work in the middle of the table to avoid upstream contamination (for instance, when taking a sample from a bottle, hold the bottle gently but firmly with one hand, keeping it slightly inclined, and work with the other hand, so that the air that comes into contact with the hand does not directly contact the inside, but rather the outside of the bottle).







6.C SWITCHING OFF THE SCS CABINET

ATTENTION: Be careful that materials in the work area can be contaminated with pathogenic material. Behave accordingly.

At the end of the work session, proceed as follows:

1. remove the material from the internal work chamber *
2. clean the work surface and the inside walls of the chamber, as indicated in the "Cleaning Instructions" section (chapter 7A)
3. Let the laminar air-flow cabinet run for 20-30 minutes after the work is over (if no UV lamp is installed)
4. turn off the light by pushing the blue key [7]
5. press "I/O" [1] key switch and enter the password for switching off the cabinet ("up-arrow" for 5 times, "down-arrow" for 4 times, then press "ENTER").
6. slide the sash window completely down
7. In alternative to above point 6, if necessary, apply UV lamp (optional) on the back wall of the work chamber, plug it into the internal socket installed on the right-hand side of the work chamber, slide the sash window completely down and switch on the germicide lamp by pushing the "U.V." yellow key [14].

6.D SLIDING GLASS INSTRUCTIONS

- To move UP the glass press  once, the glass stops automatically when it reaches the working position. When the glass is in the working position, to reach the maximum glass aperture press  +  to move the glass from the working position, keep pressed .
- To move down the glass press  and  at the same time. If the glass is above the working position, it stops automatically when it reaches the working position.

8.

7 MAINTENANCE

7.A INSTRUCTIONS FOR DAILY CLEANING OF BIOSAFETY CABINETS (by users)

Clean the outside of the SCS 1/2 cabinet, made of varnished iron-carbon sheet steel, using a damp cloth soaked in soapy water or some other commonly available products for varnished metal surfaces. The procedure to follow is:

switch off the cabinet and disconnect the feeding cable;

clean carefully all the varnished surfaces using a damp and squeezed cloth with soapy water or equivalent product.

wipe all the surfaces using a soft cloth absolutely not abrasive.

Clean/sterilize the internal work chamber with a bactericidal agent chosen according to the type of pathogenic micro-organism manipulated (e.g. hydrogen peroxide, ethyl alcohol, ethanol, phenolic compositions, aldehydes, quaternary ammonium salts, etc.).

The procedure to follow is:

switch off the cabinet and disconnect the feeding cable;

protect your hands wearing gloves if required by the bactericidal agent you are using

spray the bactericidal agent on the side walls, the back wall and the work surface in a such uniform way to avoid leaving not sprinkled zones.

do not spray the filtering upper zone to avoid damaging this part

wipe carefully all the sprinkled zones using clean blotting paper. Be sure to remove any residual of the bactericidal agent.

If pathogenic material has been spilled during the work session, sterilize the work surface, then remove it using the small handles mounted on the sides. Sterilize the spilled materials contained in the collection basin located under the table and remove all spilled material by means of absorbent paper.

For thorough cleaning we suggest the use of a 70% ethanol solution or a solution of other bacteriostatic agents.

WARNING: Never use solutions containing free chlorine (for instance, sodium hypochlorite), which cause corrosion to steel and stainless steel, resulting in irreparable damage to the cabinet structure.

7.B CLEANING OF GLASS

for the internal cleaning of the glass proceed as follows (see also para 14A) :

1. switch the cabinet off as per paragraph 6C.

move the glass up in the position of maximum opening by pushing the proper button

to have complete access to the back of the sash window open the control board [1] turning the locks [2] with the proper key (– see fig. 5))

clean the back of the sash window with suitable detergents

close the control board panel [1] and move completely down the sash window.

to have complete access to the front of the sash window open the control board panel [1]

clean the front of the sash window with suitable detergents

close the control board panel [1] locking the relevant locks [2].

ATTENTION : the inside of the sash window can be contaminated. It is operator's responsibility to decide if the sterilization is necessary before cleaning.

7.C INSTRUCTIONS FOR THE FUMIGATION/STERILIZATION OF BIOLOGIC SAFETY CABINETS

Procedure:

For gas disinfection, formaldehyde is evaporated in the tightly sealed sample chamber. The quantity of the formaldehyde used depends on the sample chamber volume of the cabinet version to be disinfected (see Technical Data).

Per cubic meter of sample chamber volume, at least 5 g formaldehyde must be evaporated with 20 ml water (corresponds with 25 ml of a 20 % formaldehyde solution). The formaldehyde evaporates immediately when its boiling point is reached. The required reaction time is at least 6 hours.

After the required reaction time, the formaldehyde should be neutralized by evaporating a 25 % ammonium solution (10 ml per cubic meter of sample chamber volume).

Ambient conditions and accessories:

The temperature at the cabinet location should be approx 21° C, the relative humidity should be between 60 and 85 %. To evaporate the solution, a heating device with a container is required.

NOTE – Disinfection procedure!

A disinfection with formaldehyde must be performed in accordance with the specifications of NSF 49/1992, Annex G. As this procedure has considerable risks, it must only be performed by specially trained and authorized service personnel!

If you use a ENVAIR formalin vaporizer follow this procedure:

1. after filling the two containers of the vaporizer according to the above-said instructions, the vaporizer can be connected to the power point inside the cabinet.
2. set the timer at 6 hours.
3. cover the cabinet completely with a polyethylene sheet which is to be carefully sealed at the bottom with adhesive tape (see enclosed picture 1); also the feeding cable of the cabinet must be sealed as shown in the enclosed picture 2.
4. start the sterilization cycle by pressing SET and STATUS key together, digit the password (3 times arrow up + ENTER). All the functions of the cabinet are deactivated except the power point. Now the fans start working for 30 secs. at intervals of 15 min. for totally 8 hours.
CYCLE: abt. 1 hour of formaldehyde evaporation, 6 hours (time set with the timer) of fumigation process, 1 hour of reagent evaporation. Total time : 8 hours.
5. when the sterilization cycle is over, the message "END STERILIZATION" is displayed
6. to go out of the programme press SET and STATUS key together, digit the password (3 times arrow up + ENTER)
7. At this point, after wearing protective gloves, protective mask and clothing the polyethylene sheet can be removed and must be submitted to special waste disposal according to possible local regulations.
8. Aerate profusely the room in order to evacuate completely the residual gas and smell.

This fumigation operation is to be considered as a suggestion.



Picture 1



Picture 2.

Post-fumigation cleaning

Having performed fumigation, the manipulation of the filters is safe: however, this manipulation should be carried out by technicians wearing protective gloves and clothing.

Before using the cabinet again any possible remains of the foregoing procedure of vaporization and relevant neutralization (which can show, for example, as white dust) must be removed from the work chamber.

ATTENTION: for cabinets that are not connected to the outside, but recycling the air in the environment, make sure that ambient concentration does not exceed $2.5\text{mg}/\text{m}^3$, as higher concentrations are harmful.

The company refuses all responsibility for the performance of such sterilization procedures or of any possible consequences deriving from it, reminding that the full responsibility for the operation lies only and exclusively with the properly trained operator-user.

7.D REPLACEMENT OF HEPA FILTERS (by technical assistance personnel)

ATTENTION: before replacing HEPA filters, the cabinet must be decontaminated (see para. 7C.) and a sterilization certificate must be issued to the technicians before starting the operation. For the safety of the personnel and the environment, the use of relevant personal protection devices is recommended as well as the collection of the replaced HEPA filters in polyethylene bags.

Replacement of main/exhaust HEPA filter (see para-14A. "Diagram for maintenance operations")

LAF Filter

1. Open the front sash window completely by pressing the “arrow-up” button
2. Switch off the cabinet and disconnect it from the mains
3. Open the control board [1] turning the locks [2] with the proper key.

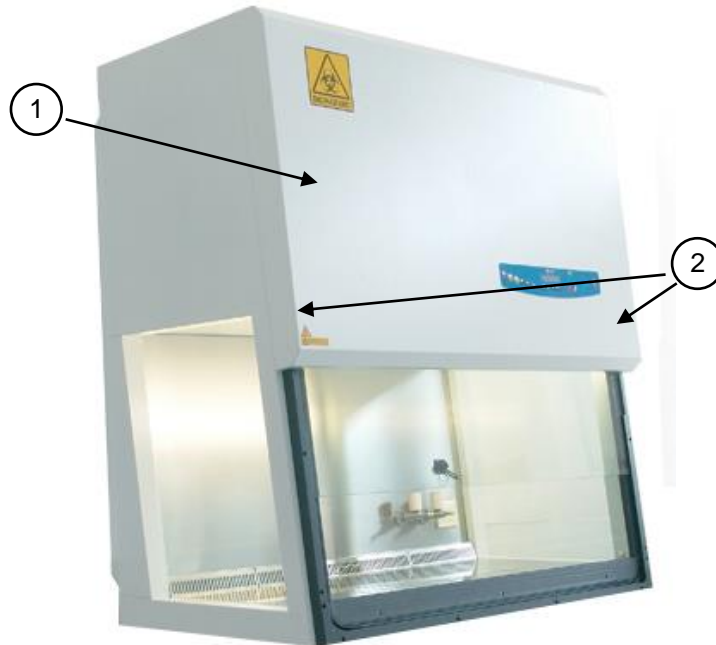

4. Remove the internal panel [3] unscrewing the relevant fastening screws.



5. Rotate the threaded bars [4] to release the HEPA filter [6].

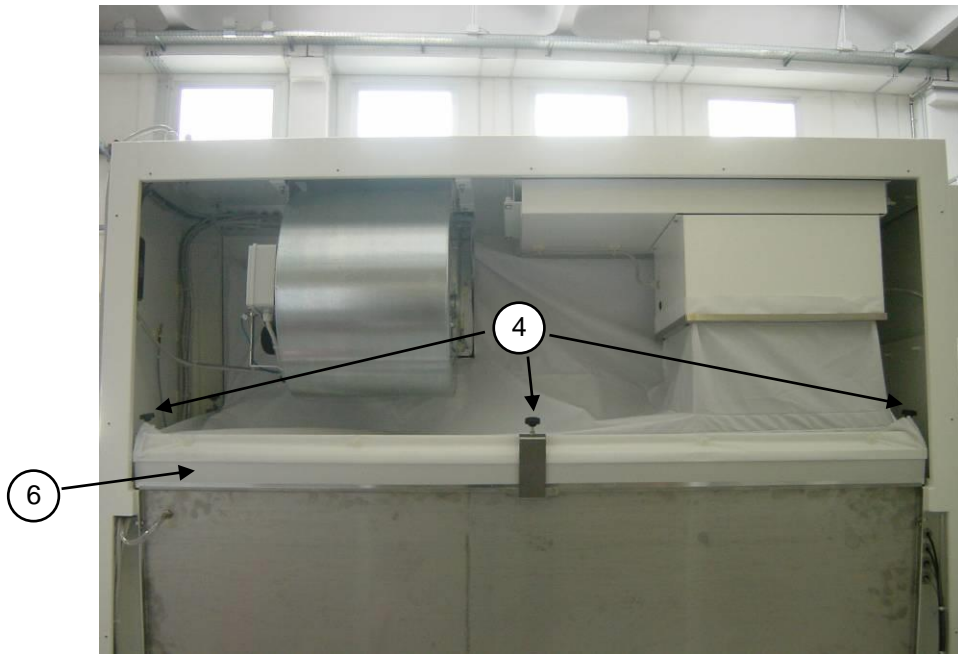

(rear view)

6. Remove the HEPA filter wearing PPD and put it in a hermetically sealed polythene bag.
7. Place the additional gasket (if it is not already present) on the filter shoulder frame opposite the shoulder gasket of filter (already present).
8. Install the new HEPA filter.
9. Lock the HEPA filter [6] by means of the threaded locking bars [4]

Exhaust Filter

10. Rotate the fastening threaded bars [7] to lift down the plenum group [8] and to release the HEPA filter

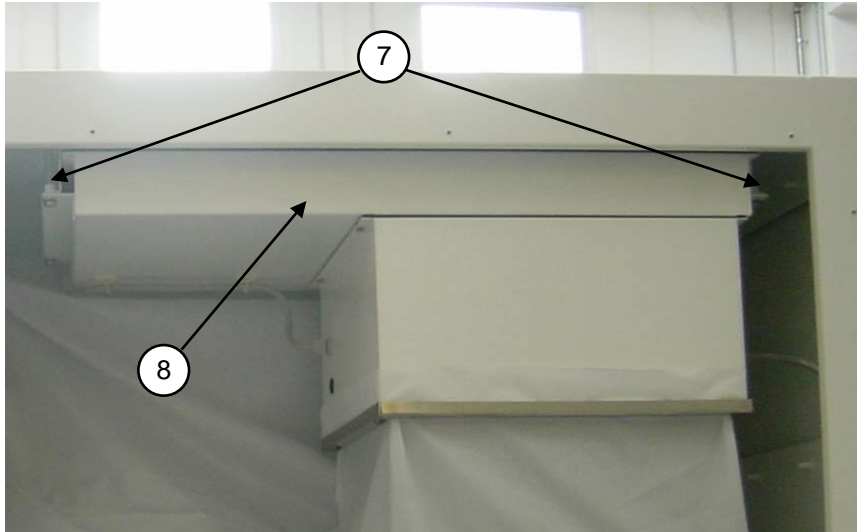

11. Proceed as indicated in above 6, 7 and 8 points.
12. Lock the HEPA filter [9] by rotating the fastening threaded bars [7].
13. Re-close the internal panel [3] with the special fastening screws.
14. Re-close the control board [1] with care and lock it with the closures [2].
15. Proceed with the necessary control-calibration procedures of the laminar air-flow cabinet.

ATTENTION: Gaskets should be of the closed-cell type and have no interstices in the joining points. Gaskets of EPDM, neoprene, hypalon, etc. may be replaced by CAF-type non-adhesive silicone.

ATTENTION: the two main/exhaust HEPA filters should be replaced at the same time. Having replaced the filters, proceed with the calibration of the motor-fan speed. Carry out a check with a particle counter and possibly a D.O.P. test. For these operations, contact your local distributor.

7.E REPLACEMENT OF MOTOR-FANS (by technical assistance personnel)

ATTENTION: before replacing the motor-fans, the cabinet must be decontaminated and a sterilization certificate must be issued to the technicians before starting the operation (see par. 7D). For the safety of the personnel and the environment, the use of PVC gloves is recommended as well as the collection of the replaced materials in polyethylene bags.

Replacement of main motor-fan.

1. Proceed as indicated in sub-section "Replacement of HEPA filters", from 1 to 4 points.
2. Remove the frame [19] in front of the fan and release the textile plenum [5]



3. Disconnect electrical connectors from terminal board in the plastic box.
4. Unscrew fastening screws [10] of the main motor-fan [11] and the flow sensor group [15] unscrewing the relevant stirrup from the motor-fan

5. Remove the main motor-fan [11] including the side stirrup [12].



6. Position the new motor-fan after having mounted again the flow sensor group [15] and the relevant stirrup.
7. Fasten the motor-fan with the relevant screws and reconnect electrical connectors.
8. Proceed as indicated in the sub section "Replacement of HEPA filters", from 13 to 15 points.

Replacement of exhaust motor-fan (only for SCS-II).

1. Proceed as indicated in sub-section "Replacement of HEPA filters", from 1 to 4 points and remove the exhaust HEPA filter.
2. Remove the textile plenum
3. Remove the anemoetric fan [14]

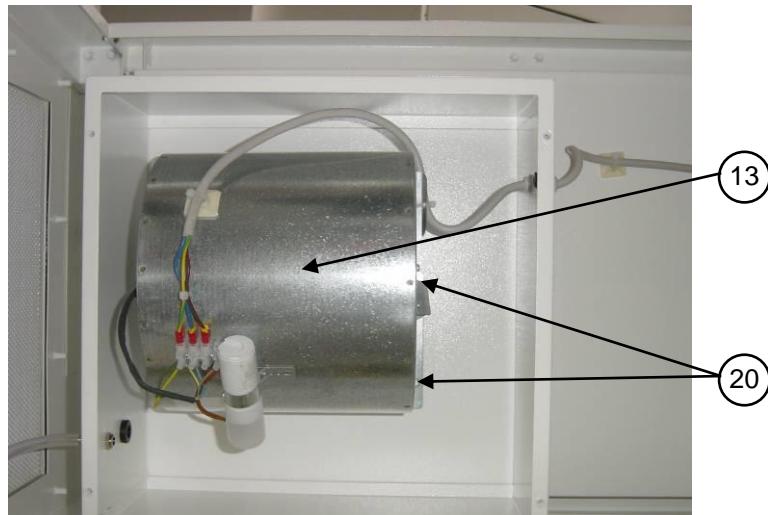

4. Remove the screws [20] of the exhaust fan [13] and the electrical connection. Place the new exhaust fan and set the wiring.
5. Re-place the textile plenum

7.F REPLACEMENT OF FLUORESCENT LAMPS (by technical assistance personnel)

Lift down completely the front sash window

Disconnect the mains power.

Open the front control panel [1] unscrewing the fastening locks [2],

Replace the lamps [16]

Close the front control panel [1] with the fastening locks [2].

7.G REPLACEMENT OF U.V. GERMICIDE LAMP (by technical assistance personnel)

Disconnect the electrical connections of the lamps from the outlet.

Remove the protection grid of the lamp

Replace the germicide bulb.

Fasten the protection grid and connect the electric connections again.

IMPORTANT: during the installation of the new U.V. lamp, pay attention not to leave fingerprints on the lamp which will block the UV effect.

7.H SPARE PARTS LIST

CODE	DESCRIPTION	SCS 1/2			
		3	4	5	6
V20000003990	24V gas electro-valve	1	1	1	1
V20000004010	Electro-valve connector	1	1	1	1
V20000004510	Plate IP-55	1	1	2	2
V20000004325	UNEL socket	1	1	2	2
V20000006030	30 W/84 fluorescent lamp	2	-	-	-
V20000006040	36 W/84 fluorescent lamp	-	2	-	-
V20000006050	58 W/84 fluorescent lamp	-	-	2	2
V20000006350	2x30W lampholder	1	-	-	-
V20000006360	2x36W lampholder	-	1	-	-
V20000006370	2x58W lampholder	-	-	1	1
V20000006900	Line Filter	1	1	1	1
V30000007500	Flat cable BIOH 15 cm	1	1	1	1
V30000000470	Potentiometer 22HP-10E	1	1	1	1
V30000000090	Proximity Namur AEG 8/2	2	2	2	2
V30000007000	MicroP "BHCPU_P" card	1	1	1	1
V30000007100	"BIOHP_A" power card	1	1	1	1
V30000007200	Glass motor control board	1	1	1	1
V30000006000	Keyboard	1	1	1	1
V40000004150	350N 234mm course gas spring	2	-	-	-
V40000004160	400N 234mm course gas spring	-	2	-	-
V40000004180	500N 234mm course gas spring	-	-	2	-
V40000004540	550N 234mm course gas spring	-	-	-	2
V40000004190	P100 support for gas springs	4	4	4	4
V40000007000	Motor to move front glass up and down	1	1	1	1
V50000000130	4 MF 450V Condenser	2	2	2	2
V50000001400	DDM 9/7, 300W C/F main motor-fan IP-55	1	-	-	-
V50000000200	DDM 9/9, 300W C/F main motor-fan IP-55	-	1	-	-
V50	DAREB 10/8 XLP2 main motor-fan	-	-	1	1
V50000000070	61022Z DDM 133-190 exh. Motor fan	1	1	-	-
V500000000480	DAREB 146-190 exh. Motor fan	-	-	1	1
V500000000900	Exh. sensor fan diam. 154	1	1	1	1
V500000000910	LAF sensor fan diam. 200	1	1	1	1
V50000100350	Main HEPA filter, 915 x 610 x 69mm	1	-	-	-
V50000100360	Main HEPA filter, 1220 x 610 x 69mm	-	1	-	-
V50000100370	Main HEPA filter, 1525 x 610 x 69mm	-	-	1	-
V50000100380	Main HEPA filter, 1830 x 610 x 69mm	-	-	-	1

V50000100220	HEPA filter 457 x 457 x 69mm (exhaust)	1	-	-	-
V50000100230	HEPA filter, 457 x 610 x 69mm (exhaust)	-	1	-	-
V50000100240	HEPA filter, 457 x 762 x 69mm (exhaust)	-	-	1	-
V50000100250	HEPA filter, 457 x 915 x 69mm (exhaust)	-	-	-	1
K60021231400	Right -hand side glass	1	1	1	1
K60021230800	Left -hand side glass	1	1	1	1
K60020930900	Frontal glass SCS 3	1	-	-	-
K60021230900	Frontal glass SCS 4	-	1	-	-
K60021530900	Frontal glass SCS 5	-	-	1	-
K60021830900	Frontal glass SCS 6	-	-	-	1
V20000006070	UV lamp15W	1	1	-	-
V20000006080	UV lamp 30W	-	-	1	1

8 MONITORING SYSTEM

ALARM OR ERROR MESSAGE	DESCRIPTION
Min. LAF Alarm	Airflow speed in the work chamber under minimum threshold value
Min. BARRIER Alarm	Insufficient air suction from the front aperture, thus air speed in the exhaust channel under minimum threshold value
LAF Triac Failure	Too fast and uncontrollable main motor-fan (LAF)
No encoder input LAF	No input from the fan anemometer installed on the LAF main motor-fan
No encoder input EXH	No input from the fan anemometer installed in the exhaust duct
Max LAF Alarm	Airflow speed in the work chamber over maximum threshold value
Front glass open	The front window is not closed correctly
UV Lifetime over	Residual lifetime of the UV lamp expired
Sensors failures	Failure to one of the sensors. Press "MUTE" key and the correspondent sensor is displayed
BLACK-OUT	Warning of black-out when the cabinet is working Press "MUTE" to stop the alarm
HEPA Filters Check	Possible clogging of absolute (HEPA) filters
Exhaust Duct Check	Possible clogging of the exhaust duct
Position the window	The sash window is not in the correct position
F1 (2, 3, 4, 5) lifetime over	Filter 1 (2, 3, 4, 5) residual lifetime is over
ATTENTION DANGER Reduced airflow. DO NOT WORK	Warning to pay attention when the speed reduction is activated (only for keyboards with "SPEED REDUCTION" key)
CHECK THE GLASS	The view-screen has not moved properly Check there are not obstacles below the screen. In case the screen is blocked by an obstacle, call technical assistance.

9 TROUBLESHOOTING - Probable causes of malfunctions

PROBLEM	CAUSE	REMEDY
Cabinet does not work	<ul style="list-style-type: none"> – the electricity supply has been cut off at the mains – Electronic board out of order – Blown fuse(s) 	<ul style="list-style-type: none"> – check the voltage input to the cabinet – Replace PCB – Replace fuses
Alarm: “HEPA filters check”	Main HEPA filter clogged	Replace HEPA filter
Alarm: “low barrier velocity”	Double-fan cabinet: the exhaust motor-fan does not work	Check the exhaust motor-fan Check F6 fuse on the power card Check that the exhaust duct is not clogged
	Single-fan cabinet	Check that the exhaust duct is not clogged
“minimum LAF alarm”. [Possible contamination of the product but protection of the environment]	HEPA filters clogged .	Replace HEPA filters.
	The main motor-fan does not work	Check the terminal voltage of the power card of the main motor-fan Check F7 fuse on the power card Replace the power card Replace the microprocessor card
“Black-out ” Alarm (probable exchange of air between the work chamber and the outside and possible contamination of the environment)	Blackout	Check the feeding cable, the connection plug/socket, the power supply line Press “Mute” [15] key to silence the alarm
Alarm “Sensors failure”	Failure of sensor XX	Replace XX sensor.
Alarm: “No encoder input LAF”	No signal from LAF flow sensor	Replace the LAF sensor
Alarm: “No encoder input EXH”	No signal from Exhaust flow sensor that is out of order	Replace exhaust sensor

10 TRANSPORT, PACKING and STORAGE INSTRUCTIONS

ATTENTION: Disconnect the power and sterilize the unit before performing any of the following operations

The following instructions are essential if the end user needs to transport, pack or store a cabinet after a period of routine use (e.g. laboratory/plant relocation):

- Disconnect tubes for gas/vacuum
- If the cabinet exhausts to the outside of the building or is connected to the intake channel of the air treatment system, remove the connection tube from the cabinet to the outside or cabinet to the air treatment system. Be careful not to damage or cover with dust (or any other material) the exhaust filter of the cabinet
- Remove the work surface and cover it with a protective film
- Close the cabinet front opening

If the cabinet is to be moved from one laboratory to another within the same building:

- on a table with wheels: it is sufficient to put the cabinet on the table; do not place it on one side or on the back panel.
- by a forklift: put the cabinet on a pallet to ensure good stability and to protect the basin under the cabinet and the front window against damage in transit

Take care not to damage protruding parts (e.g.: gas/vacuum taps, exhaust duct) when passing through doors/windows

If the cabinet is to be kept temporarily unused at final destination, cover the cabinet itself with a protective film (pluriball or expansible film) taking care to protect also the exhaust filter, especially from dust

We recommend extreme caution in long-distance moving carried out by forwarding agents (e.g. change of address): we suggest that you use the original packaging supplied by the manufacturer with the cabinet.

Packaging characteristics:

Wooden pallets of the following dimensions:

SCS 3:	113 x 90 x 12 cm.
SCS 4:	145 x 90 x 12 cm
SCS 5:	175 x 90 x 12 cm
SCS 6:	205 x 90 x 12 cm

Cardboard base to be laid on the pallet of the following dimensions:

SCS 3:	110 x 87x 1 cm. (sp.)
SCS 4:	142 x 87x 1 cm. (sp.)
SCS 5:	172 x 87x 1 cm. (sp.)
SCS 6:	202 x 87x 1 cm. (sp.)

Pluriball to wrap and protect the cabinet from dust

Cardboard outer package of the following dimension:

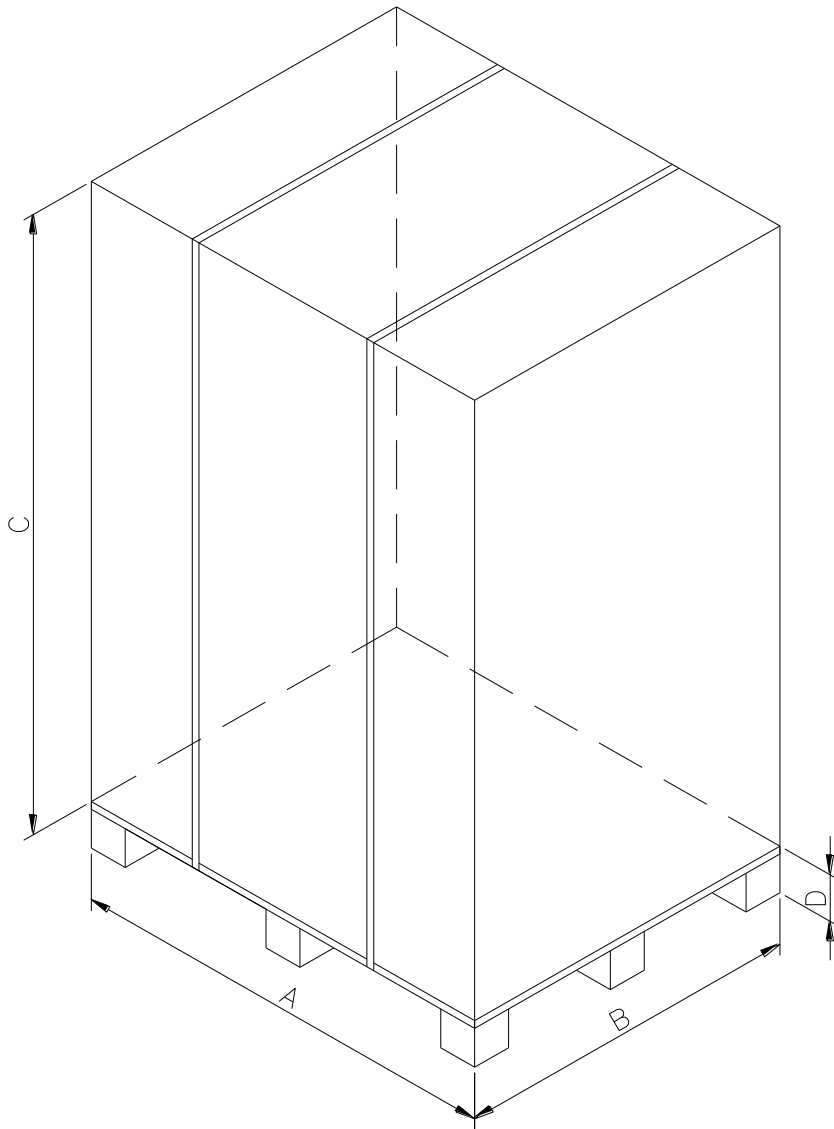

Cabinet model	A	B	C	D
SCS 3	1130	900	1600	120
SCS 4	1450	900	1600	120
SCS 5	1750	900	1600	120
SCS 6	2050	900	1600	120

Steel straps and clips

During transport take care to maintain the package in a vertical position (i.e. the pallet at the bottom)
The cabinet (with or without the package) must be kept in a place with the following environmental conditions:

- Min. temperature: 0°C
- Max. temperature: 60°C
- Max. humidity: 95%

11 ADDITIONAL INFORMATION

11.A GUARANTEE

The guarantee for SCS 1/2 Biohazard vertical laminar air-flow cabinets is 24 months from date of invoice.

In addition to those cases specifically indicated in Chapter 5 relating to improper use of the cabinet, the guarantee offered, also excludes certain improper uses described in the instruction manual, of which the most important are listed again below :

installation in a place which does not conform to the manufacturer's recommendations

wrong power voltage

poor earthing

use of chlorine or its derivatives, incompatible with stainless steel, for cleaning the cabinet,

tampering or changes made by the client

tampering with the cabinet using any type of tool

improper connection between the electrical outlet and the power cable, wrong connection between the gas cock or electro-valve and gas mains

11.B ADDRESS FOR TECHNICAL ASSISTANCE (for the distributor)

12 TESTS PERFORMED ACCORDING TO EN 12469 STANDARD

12.A MEASUREMENT OF LAMINAR AIRFLOW VELOCITY

The LAF velocity is measured at 10 cm. over the bottom of the front window. The standard provides for the reading in at least 8 points:

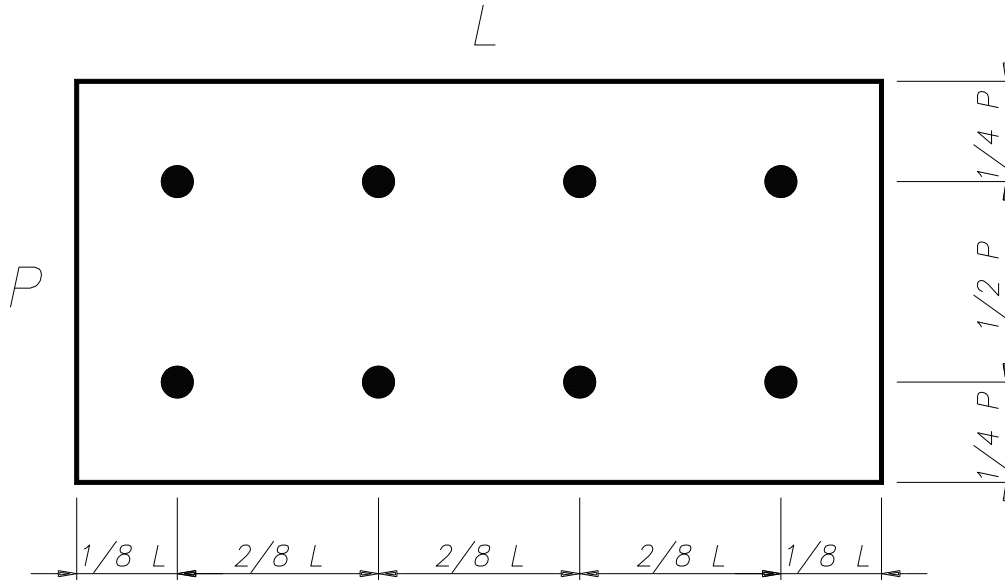

In our tests the readings are taken in 12 points as above-diagrammed. Each one of the 12 readings lasts at least 1 minute. The velocity is measured with a hot-wire thermoanemometer with the following features:

Measure-Range	0÷2 m/s
Precision (of the device including the probe)	+/- 0.05 m/s +/- 5%
Working temperature	from – 20 to + 70°C.
Resolution	m/s

The average velocity is obtained by the following formula:

$$\text{Average velocity} = (V_1 + V_2 + \dots + V_n) / n$$

n = number of readings points

V_1, V_2, \dots, V_n = velocities measured in the various points.

The average velocity must be within the range of 0,25 und 0,5 m/sec

Ensure that no single measurement differs from the average of all the measurements by +/- 20 %.

12.B MEASUREMENT OF THE EXHAUST AIR VELOCITY

Measure the average velocity on the exhaust HEPA filter by means of an anemometer with the following features :

Precision	+/- 0.2 m/s +/- 5%
Working temperature	from - 20 to + 70°C.
Resolution	m/se

Being careful to set the device properly.

Report the reading of the average exhaust velocity (V) in the "Test Report" showing also the other data requested i.e. the section (in m²) of the exhaust duct (S1) and the section (in m²) of the working aperture of the cabinet (S2).

Now the air barrier velocity (VI) is given by the following formula:

$$VI = (V \times S_1) / S_2$$

Also this value must be reported in the "Test Report".

The air barrier velocity must be ≥ 0.4 m/s

12.C MEASUREMENT OF THE NOISE LEVEL

For a correct testing the background noise in the laboratory with the cabinet off should not exceed 55 dBA.

The microphone of the phonometer must be placed at 1 m from the centre of the working aperture of the cabinet between the glass and the work surface or 1m from any part of the cabinet.

The sound pressure level must not be over 65 dBA. (sound level according ISO 3746).

The measure taken must be reported in then "Test report".

12.D MEASUREMENT OF LIGHTING

Take the measure with a luxmeter placed inside the work chamber in the middle of the work surface.

Consider at least 4 readings points where the two side points should be 150mm away from the side walls and the middle points will be spaced max. 300mm apart, if possible. Then calculate the average value, which should be at least 750 lux.

Register the average value of the lighting in the "Test report".

12.E MEASUREMENT OF VIBRATION

Take the measures with a vibration analyser, which is to be placed as follows according to the models:

- SCS 3 in the middle of the central section of the work surface
- SCS 4/5/6 : in the middle of the two central sections of the work surface

The test must be performed firstly when the cabinet is off and then when the cabinet is working.

The difference of the taken values is the real datum of the cabinet vibration. This value should not exceed 0.005 mm RMS

Record the data in the "Test Report"

12.F CONTROL OF ALARMS

ALARM FOR MISFUNCTIONING OF MAIN MOTOR-FAN (LAF)

This alarm can be simulated by disconnecting the feeding cables of the main motor-fan. When the cabinet is switched on and the "stand-by" period is over, check that the red light of the relevant alarm and the visual and sound (buzzer) signals start.

ALARM FOR MISFUNCTIONING OF SECONDARY MOTOR-FAN (EXHAUST)

Also this alarm can be simulated by disconnecting the feeding cables of the main motor-fan. . When the cabinet is switched on and the "stand-by" period is over, check that the red light of the relevant alarm and the visual and sound (buzzer) signals start.

ALARM FOR REDUCTION OF THE EXHAUST DUCT CAPACITY

To verify this alarm, clog the exhaust duct gradually at the end of stand-by period and check that the red light of the relevant alarm and the visual and sound (buzzer) signals start. Furthermore check that when the clogged duct is cleared, the alarm stops.

ALARM FOR CHANGING THE STANDARD OPENING OF THE SASH WINDOW OF THE CABINET

To verify this alarm it is enough you move the front sash window from its standard work position by pressing the relevant keys and check that the red light of the relevant alarm and the visual and sound (buzzer) signals start. Re-position the sash window in its standard work position and check that the alarm stops.

ALARM FOR REDUCTION OF LAMINAR AIRFLOW VELOCITY IN THE WORK CHAMBER

During the normal working of the cabinet, cover the work surface almost completely with a PVC or cardboard sheet and check that the relevant red light switches on. When the correct operating conditions of the laminar airflow are restored, the alarm will stop.

OTHER ALARMS

With the help of technicians also the alarms for LAF and protection barrier velocity below the minimum threshold or over the maximum threshold can be checked

12.G D.O.P TEST FOR MAIN AND EXHAUST HEPA FILTER

OBJECT AND PRINCIPLE OF THE TEST:

Check of the integrity of the HEPA filters through an analysis of the filtering system, able to find out possible small leaks and/or defects altering the efficiency of the filters and at the same time to test leaks around gaskets.

The HEPA filter system fitted to the cabinet is tested for leakage by subjecting it to an aerosol on the upstream side and measuring passage of the aerosol to the downstream side

INSTRUMENTS TO BE USED FOR TESTING :

1. Aerosol generator
2. Photometer

REAGENTS:

Liquid aerosol agent composed of Emery 3004 or equivalent in concentration of 60 microg./l.

Suitable measures must be taken to prevent or reduce the operator's exposure to aerosol.

TEST PROCEDURE:

The photometer must be used at a threshold sensitivity specific to the test aerosol of 0.0001 micro-g/l and capable of measuring aerosol concentrations up to about 80 micro-g./l.

The test must be performed as follows:

- Place the aerosol generator in such a way that the aerosol produced is immediately caught by the barrier airflow and then recycled into the intake channel
- Switch the generator on and adjust the photometer to give a reading of 100% when sampling this concentration
- Ensure that the threshold of reading sensitivity of the photometer is 0.0001 microg./l.
- Operate the cabinet with airflow velocity as per specs.
- Using a sampling probe attached to the photometer scan the main and exhaust filter faces, seals and construction joints, moving the sampling probe at not more than 30 mm/s
- Check the values read by the photometer constantly, in order to detect possible leakage.
- Acceptance criteria: downstream reading must be less or equal to 0.01%

12.H INSTRUCTIONS FOR THE CLEANING TEST OF BIOLOGICAL SAFETY CABINETS

ATTENTION: Before carrying out the cleaning test wear the suitable rubber gloves to avoid direct contact with parts potentially contaminated.

The first step of the test is to pour some drops of milk inside the work chamber on several points included those more difficult because near the edges and corners.

Then the whole work chamber must be cleaned and brushed carefully, at first by using a lukewarm solution of water and soap (for the cleaning use a sponge and in the most critical points a brush) and then, after wiping the whole chamber, isopropyl alcohol.

The check that all contaminants have been removed can be performed by means of a microbiological test called IGIENEST HACCP 100, which is able to find out the presence of residual proteins and sugar, or equivalent

Method:

1. Add a drop of B Reagent (included in the test kit) in a test tube already containing A reagent
2. Shake the test tube gently: the solution will become green. Move the test tube into its support inside the kit
3. (N.B.: do not close the test tube with the thumb because the contact with the skin could distort the result. Use the cap)
4. Take a pad, being careful not to touch the end. The pad must be used only once: its re-use gives wrong results. If the surface to be tested is dry, add one or two drops of the hydrating solution included in the kit. Do not use water to wet the pad
5. Pressing firmly, rub the pad on the surface which is to be tested repeatedly. Do not touch the end of the pad in fibre in order not to distort the results
6. Move the pad into the test tube previously prepared. The pad must be well soaked in the solution. Wait 10 minutes for the reaction.
7. After about 10 minutes the reaction generates the colour, which is to be interpreted according to the following table:

Level 1	Level 2	Level 3	Level 4
Green colour	Grey colour	Violet colour	Dark Violet colour
0 micro-g proteins on the surface	100 micro-g proteins on the surface	300 micro-g proteins on the surface	1000 micro-g proteins on the surface
Judgment	Judgment	Judgment	Judgment
good	At the limit	unsatisfactory	unsatisfactory

12.1 EVALUATION OF PROTECTION FACTORS

The test shown here below can be performed when installing the cabinet.

The operator protection factor (Apf) is defined as the ratio of exposure of airborne contamination generated on the open bench to the exposure resulting from the same dispersal within the cabinet under test.

The expression for the protection factor becomes:

$$(N \times V) / (10^4 \times n)$$

where:

N = number of particles liberated

n = the number recovered at a sampling rate of V (dm³/min)

The value of n is determined from an examination of the developed and dried filter membrane,

For a biological safety cabinet, which is to pass the containment test, the total number of spots of potassium iodide on the membrane can be easily counted by examining each filter with x 10 magnifier at disposal

The N value (number of generated spots of potassium iodide) is calculated by the expression

$$N = 3.1 \times 10^7 \times M$$

where

M = quantity of potassium iodide expressed in ml dispersed by the aerosol generator (20 ml)

This expression incorporates the constant derived from droplet size, flowrate and velocity of disk rotation.

The sampling flowrate V is 100 dm³/min when the vacuum on the air sampler is 8" of water column (200 mm of H₂O)

Required tests: at least 5 consecutive tests must be performed, each of one must give a protection factor not less than 10⁵ estimated for each sampling.

BACKGROUND TEST

Before performing the test on Biological Safety cabinets make sure that the environment is not contaminated by Potassium iodide.

Proceed in performing the tests in the same way as in the measurement of the protection factor.

A count of more than 5 spots in one of the two membranes during a 10 min test should be regarded as unsatisfactory

KI-DISCUSS – TEST PROCEDURE

Pour 20 ml potassium iodide solvent into the mist generator.

Be careful that the needle valve is closed.

The suction fan is to be activated 30 seconds before the generator.

When the green light on the control panel is on (which shows that the disc runs at the correct speed) open the needle valve from 1/10 to 1/12 turn anticlockwise allowing then the solution to feed on to the centre of the spinning disc through the silicone rubber pipe and the hypodermic pipe.

The solution passing through the pipe as well as the mist generated by the spinning disc are visible.

The correct dimension of the particles is produced by the spinning disc when the quantity of potassium iodide flow varies from 1 to 2 ml/min. It is important to check this change of flow measuring the time taken to empty the container. This control ensures that the hypodermic pipe is not partially clogged.

When the test is over, a small quantity of solution usually remains in the hypodermic pipe, which is responsible for the clogging of the pipe when it is filled in again and the needle valve opened. For this reason it is advisable to squash the silicone pipe near the hypodermic pipe once or twice in order to clean it and allow a constant flow. The cycle during which the potassium iodide solution flows on the spinning disc should be over in abt. 15 min.

Turn the disc motor off but continue to run the fan for a further 5 min to recover any dispersed particle.

When the suction fan has completely stopped, incline the air samplers vertically, remove the cover of a sampler, unscrew the brass cone and remove the filter membrane.

Place the membrane in the petri dish containing the palladium chloride solution, with the surface that has been exposed to the airflow facing upwards.

Note the sampler from which the membrane was removed.

Within 30 s to 45 s the membrane will become saturated with palladium chloride and any potassium iodide particles will become visible as brown spots. Remove the membrane and immerse in distilled water for 3 s to 4s and then place it on a clean filter paper to dry.

The membrane must be kept in the suitable container waiting for the test.

Repeat this procedure with the filter membrane from the other air sampler. Replace cover over the petri dish.

Be careful that the tweezers used for placing the membrane in the palladium chloride solution are not used for loading the air samplers.

EXAMINATION OF THE FILTER MEMBRANES

Examine each filter membrane with x 10 magnifier and count the number of brown spots on the filter membrane

If the number exceeds 50/100 it will be necessary to use a graticule with the magnifier and to count the spots within a square or a convenient circle and to use an appropriate multiplication factor as per following table:

GRATICULE CIRCLE (diameter)	Y FACTOR
2,5 mm	77
2,0 mm	121
1,0 mm	483
0,9 mm	597
0,8 mm	756
0,7 mm	988
0,5 mm	1.935

SQUARE ON THE GRATICULE

1 cm ²	3,8
Quadrato più piccolo	1.520

These factors take into account the percentage of the total surface of the membrane area on which the particles can deposit.

13 DRAWINGS AND DIAGRAMS

LEGENDA

Ref. DESCRIPTION

1	Control board panel
2	Control panel locks
3	Internal panel
4	LAF plenum tie-rod
5	LAF plenum
6	Main HEPA filter
7	Screws fixing exhaust motor-fan
8	EXHAUST plenum
9	EXHAUST HEPA filter
10	Screws fixing Main motor-fan
11	Main motor-fan
12	Stirrup main motor fan
13	EXHAUST motor-fan
14	Exhaust anemometer fan
15	Main anemometer fan
16	Lamps
17	Work chamber
18	Work surface
19	Frame
20	Fixing screw
21	UV lamp socket
31	UV lamp carter
32	UV lamp
33	UV lamp holder

13.A DIAGRAM FOR MAINTENANCE OPERATIONS

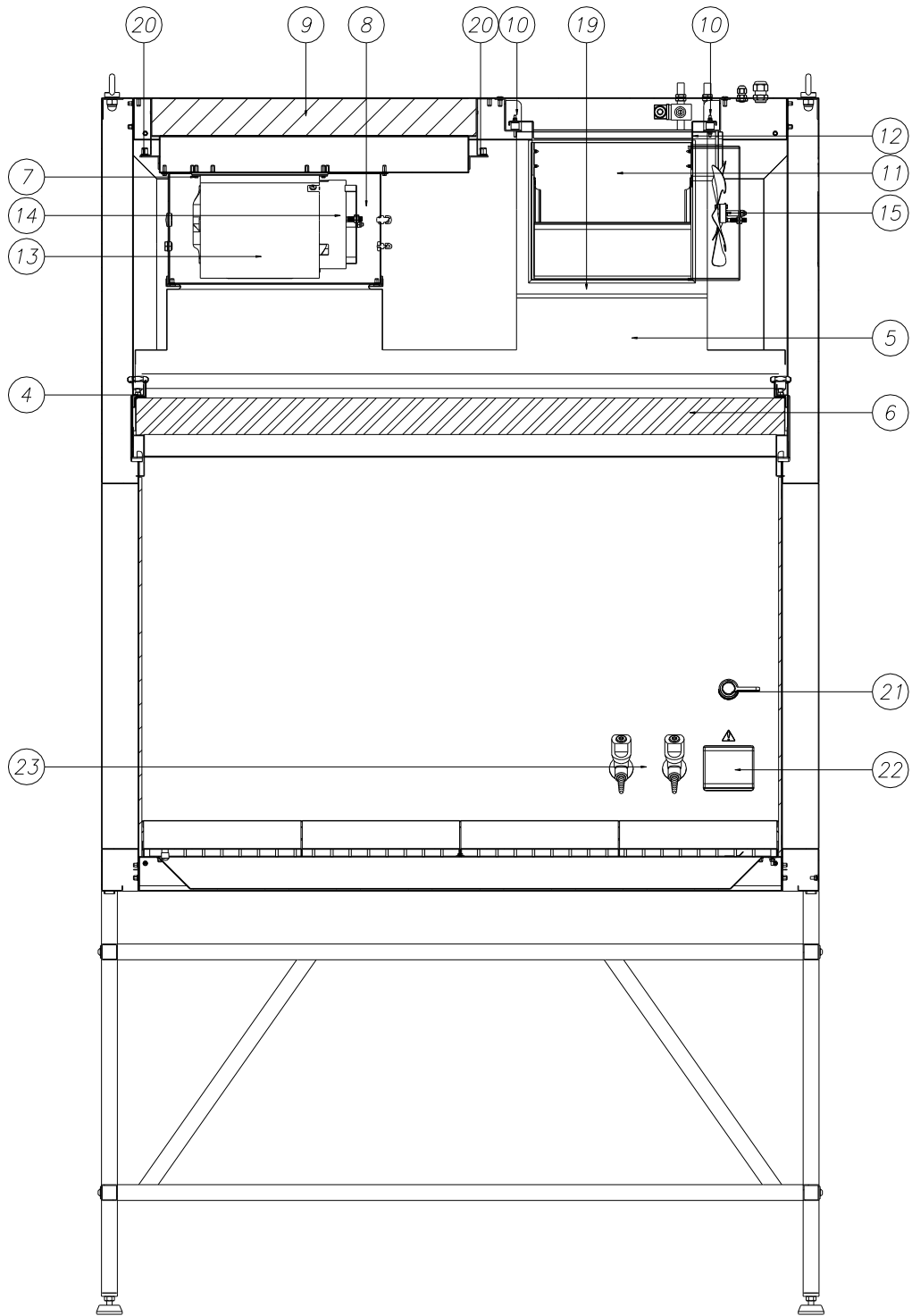

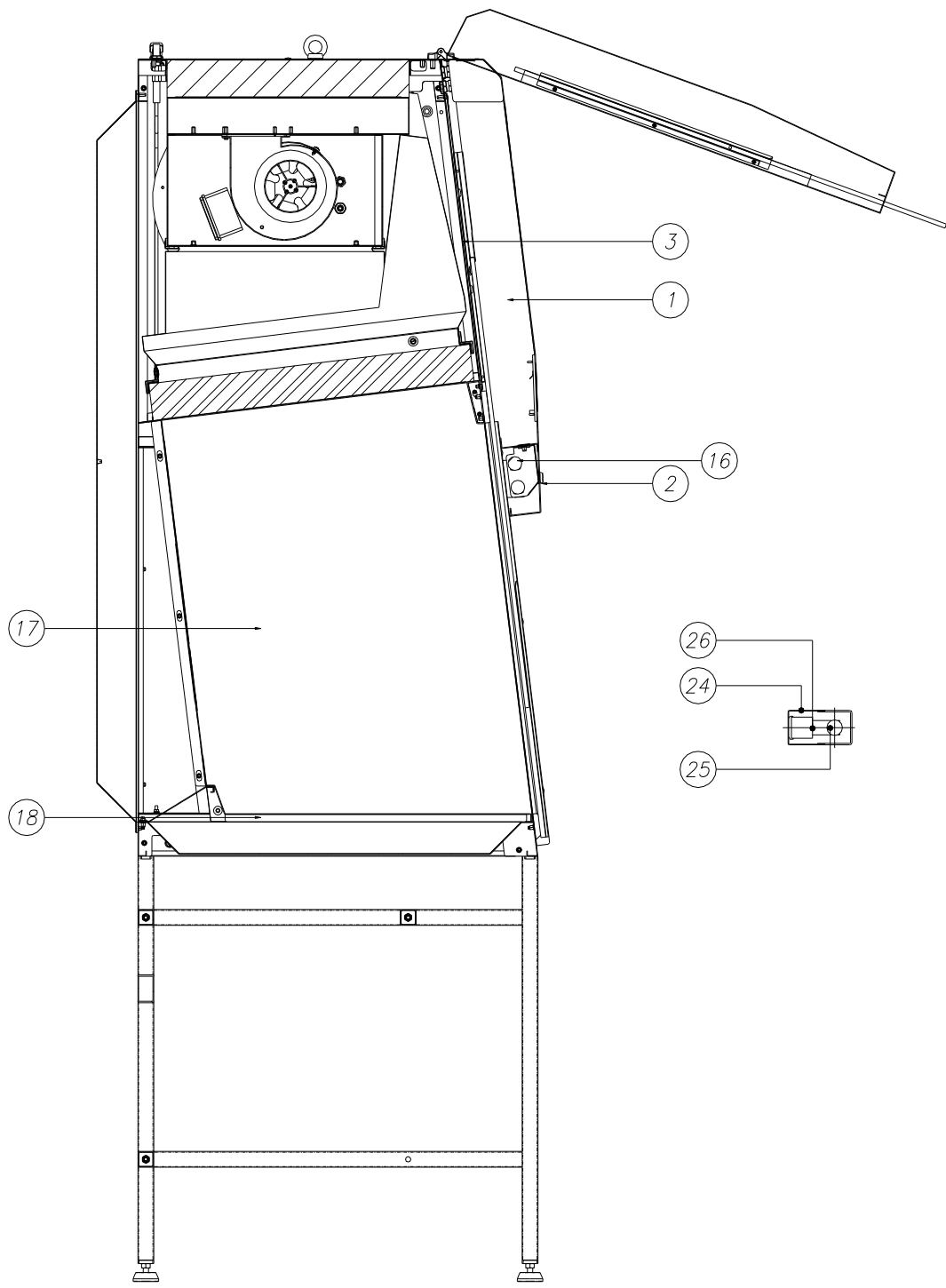

13.B FRONTAL DIAGRAM

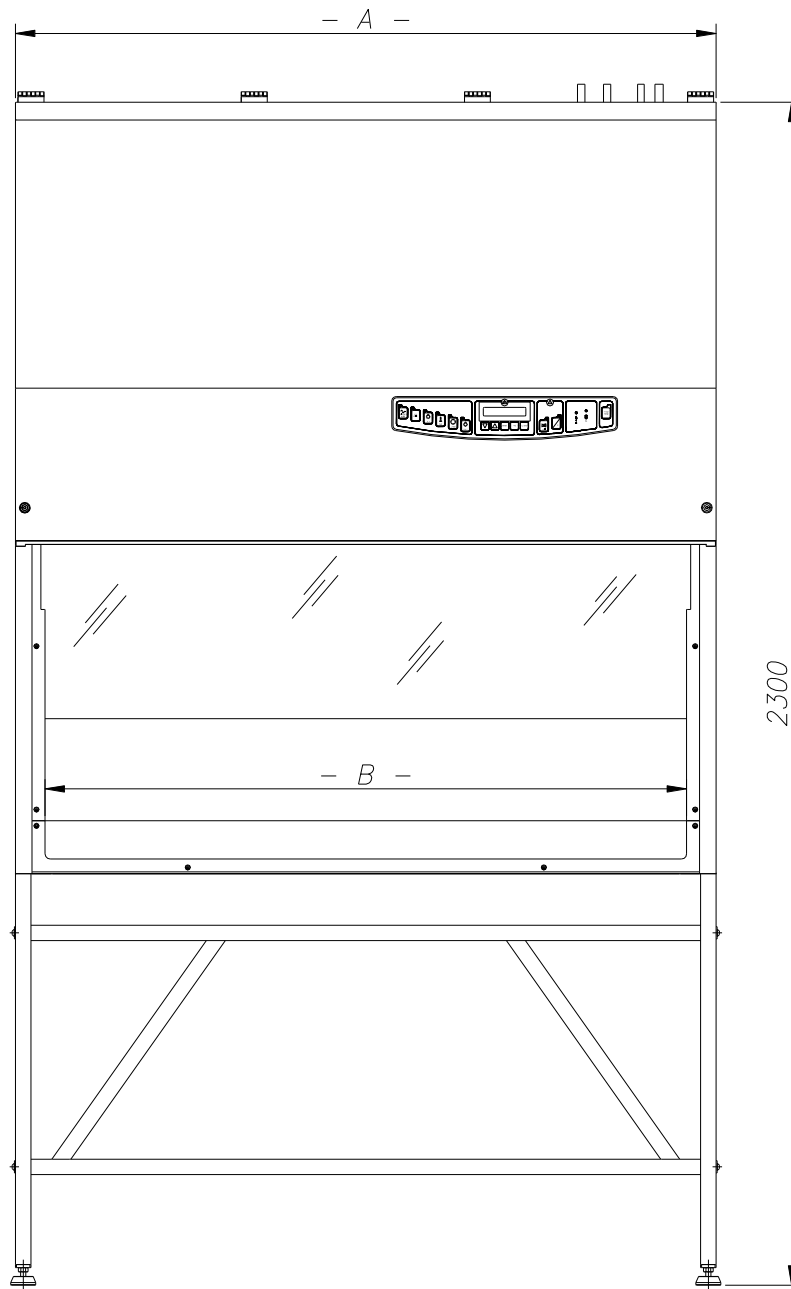

SCS	A	B
3	1045	899
4	1350	1194
5	1655	1499
6	1960	1804

13.C SIDE DIAGRAM

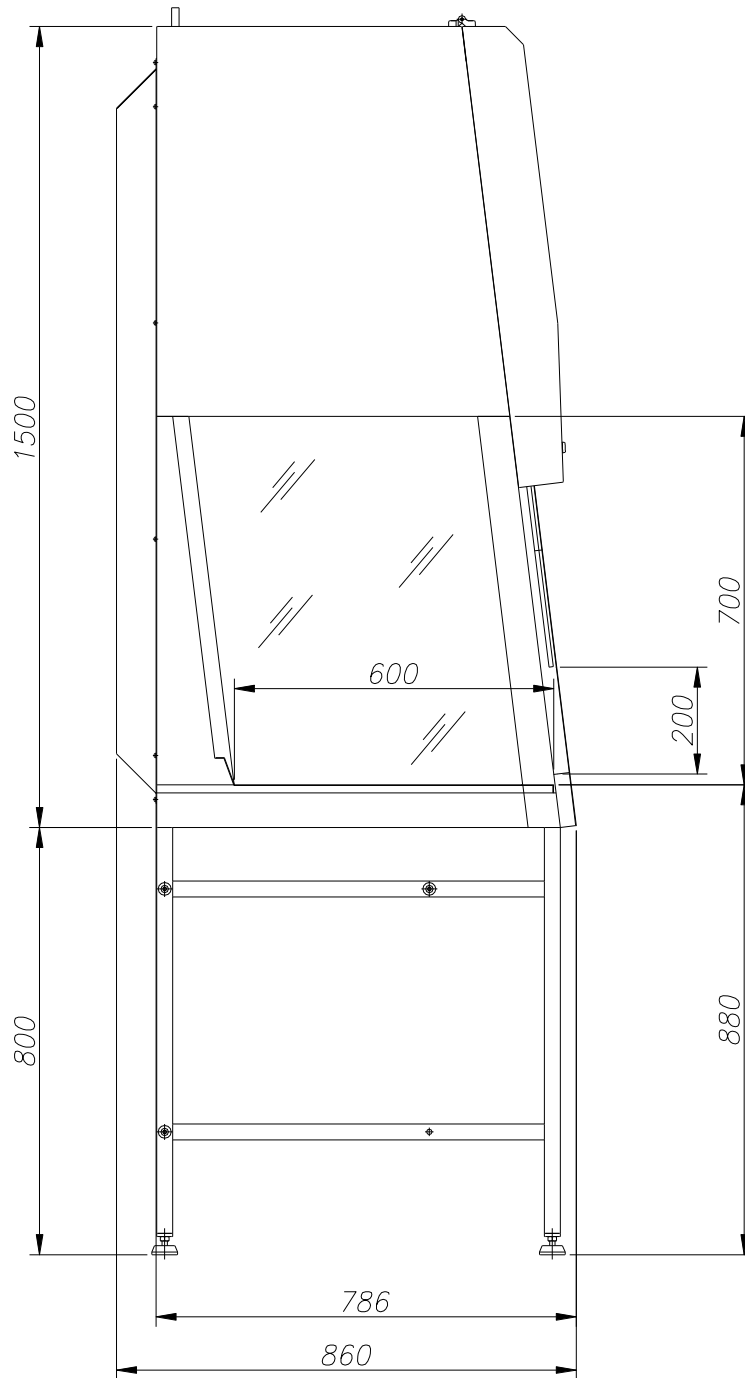

14 ASSEMBLY of SUPPORT TABLE

The supporting stand is supplied not assembled, with, the kit of screws and the feet.

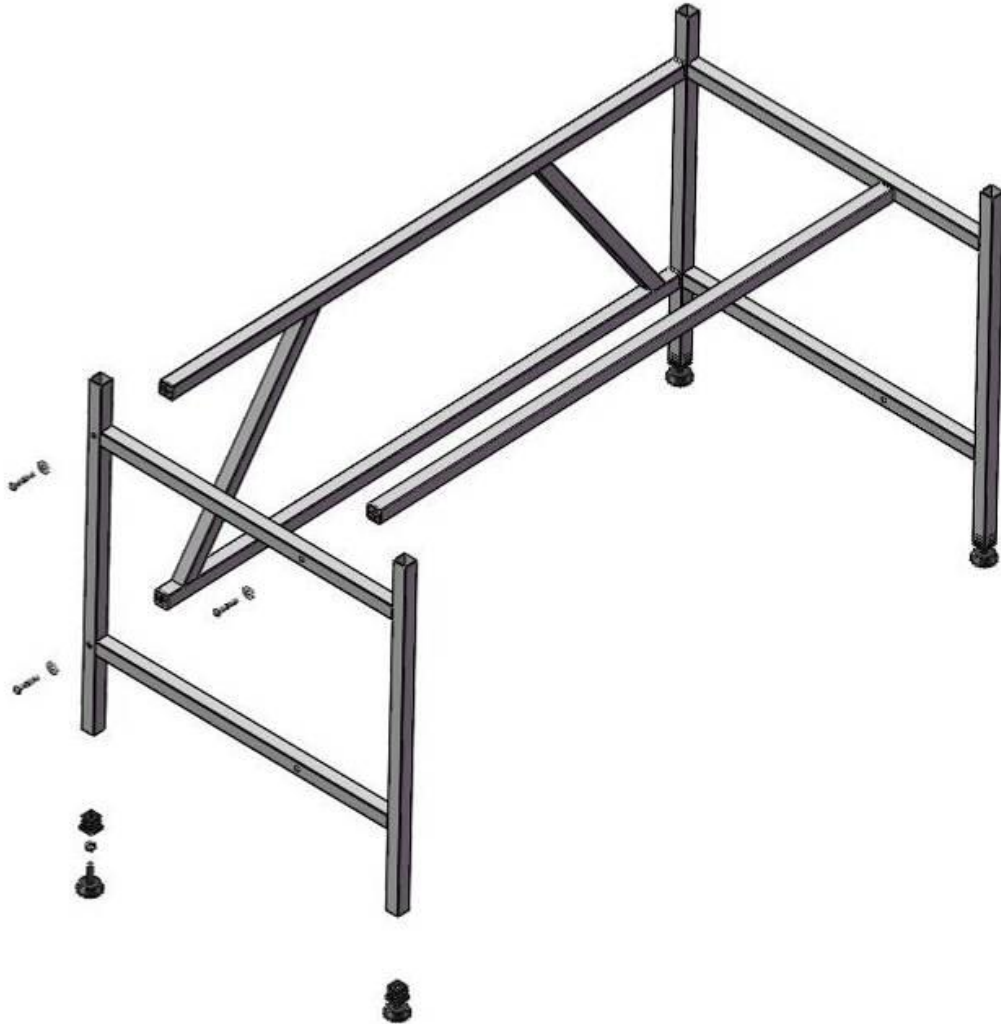

15 ASSEMBLY OF THE CABINET ON THE SUPPORTING STAND

When the stand has been assembled the cabinet can be installed following this procedure :

- Check the correct levelling of the stand and in case adjust the height of the feet [3]
- Check the tightening of all the screws and the firmness of the stand
- Lift the cabinet with suitable equipment (for example a forklift) complying with the safety rules (the weight of the cabinet is shown in the “table of technical features” para. 9) and put it on the stand
- Put the cabinet on the stand , taking good care to fit together the jutting feet of the cabinet and the cavities of the stand

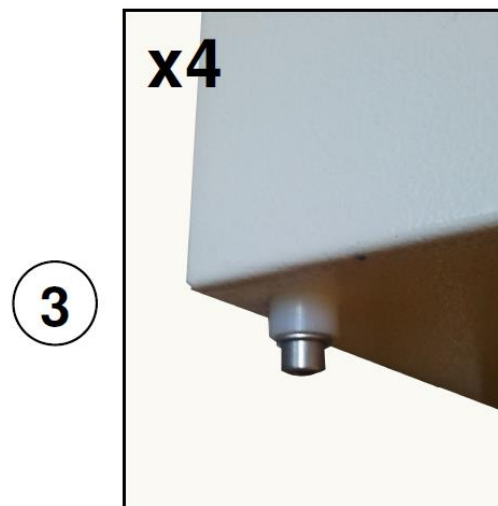
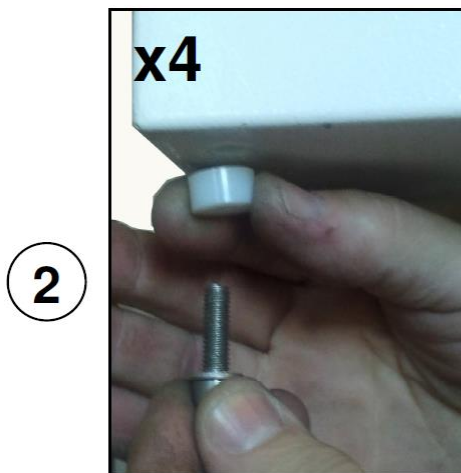

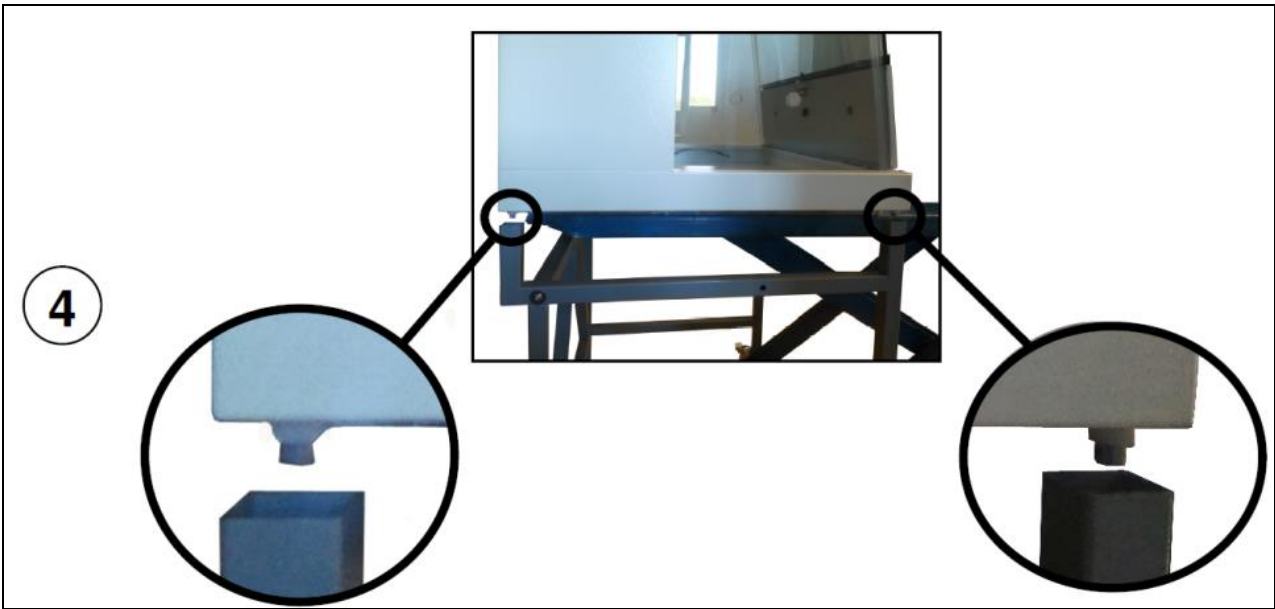

- The two eyebolts positioned on the top of the cabinet can be used to lift the cabinet

16 SAFE WORKING AREA DIAGRAM

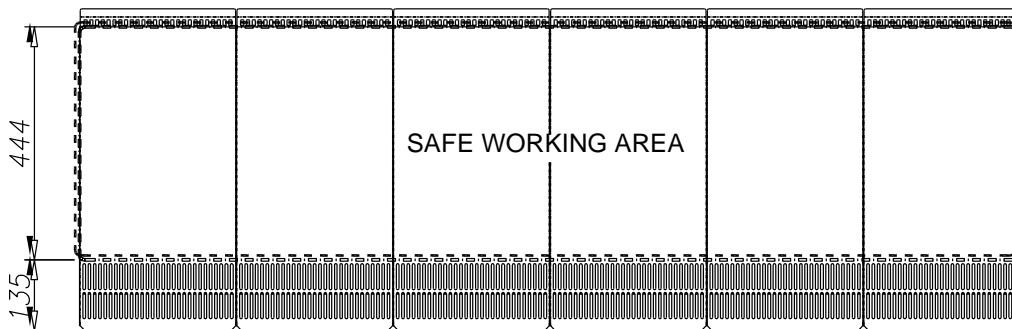
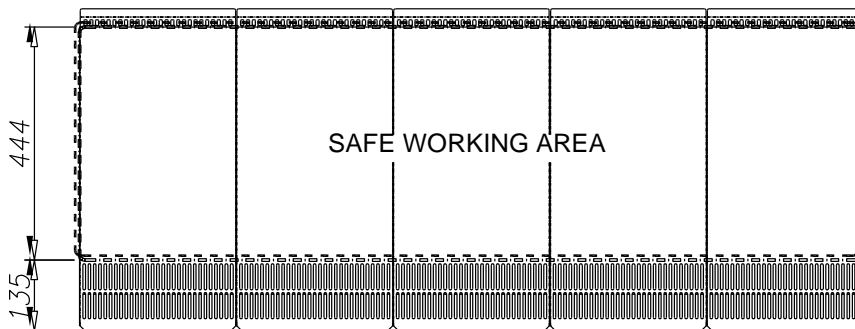
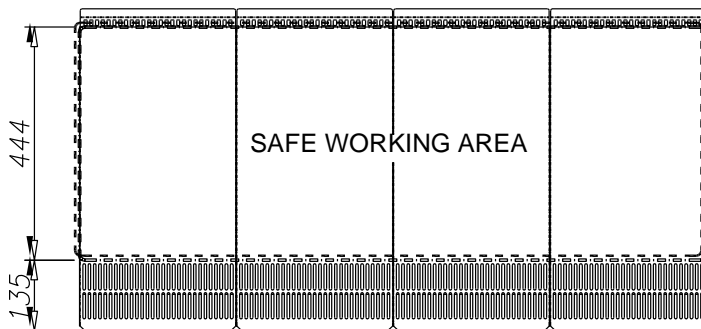
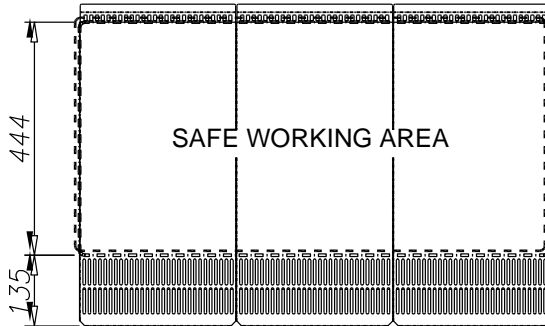

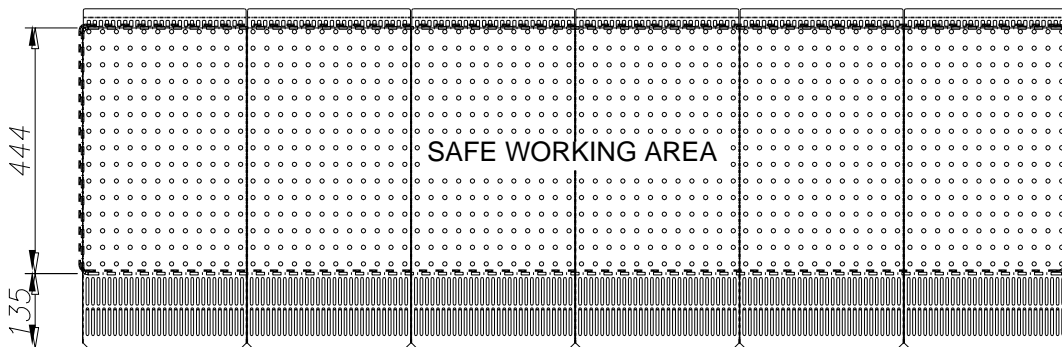
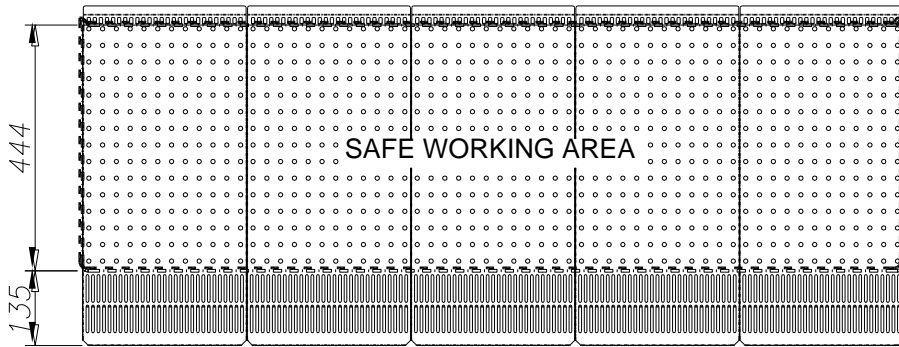
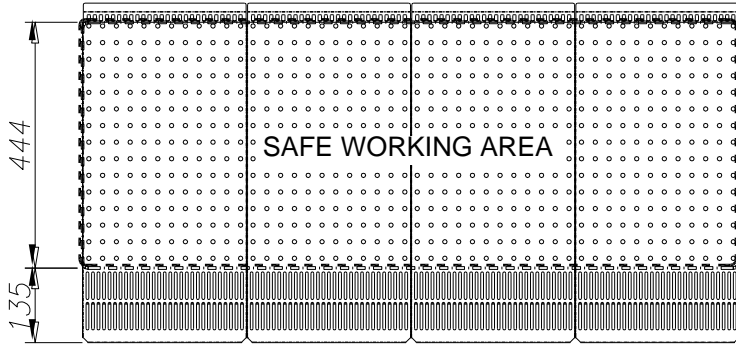
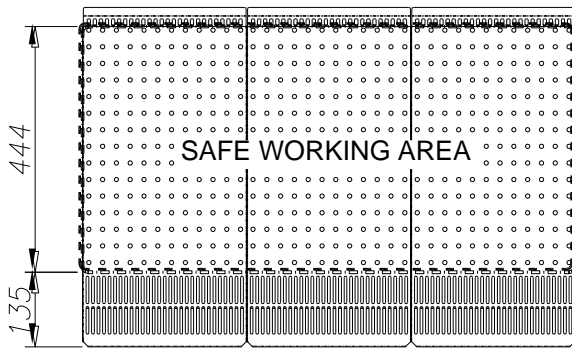

17 SENSORS LIST

PCB PLUG	SOFTWARE NAME OF THE SENSOR	DESCRIPTION
J4	S16	GLASS POTENTIOMETER
J9	S0	LAF
J10	S1	EXH
J11	S2	not used
J12	S3	not used
J13	S4	not used
J14	S5	not used
J15	S6	not used
J16	S7	not used
J17	S8	Card NBHG
J18	S9	Card NBHG

18 WIRING DIAGRAM

18.A SCS 3 – 4 (230V 50Hz)

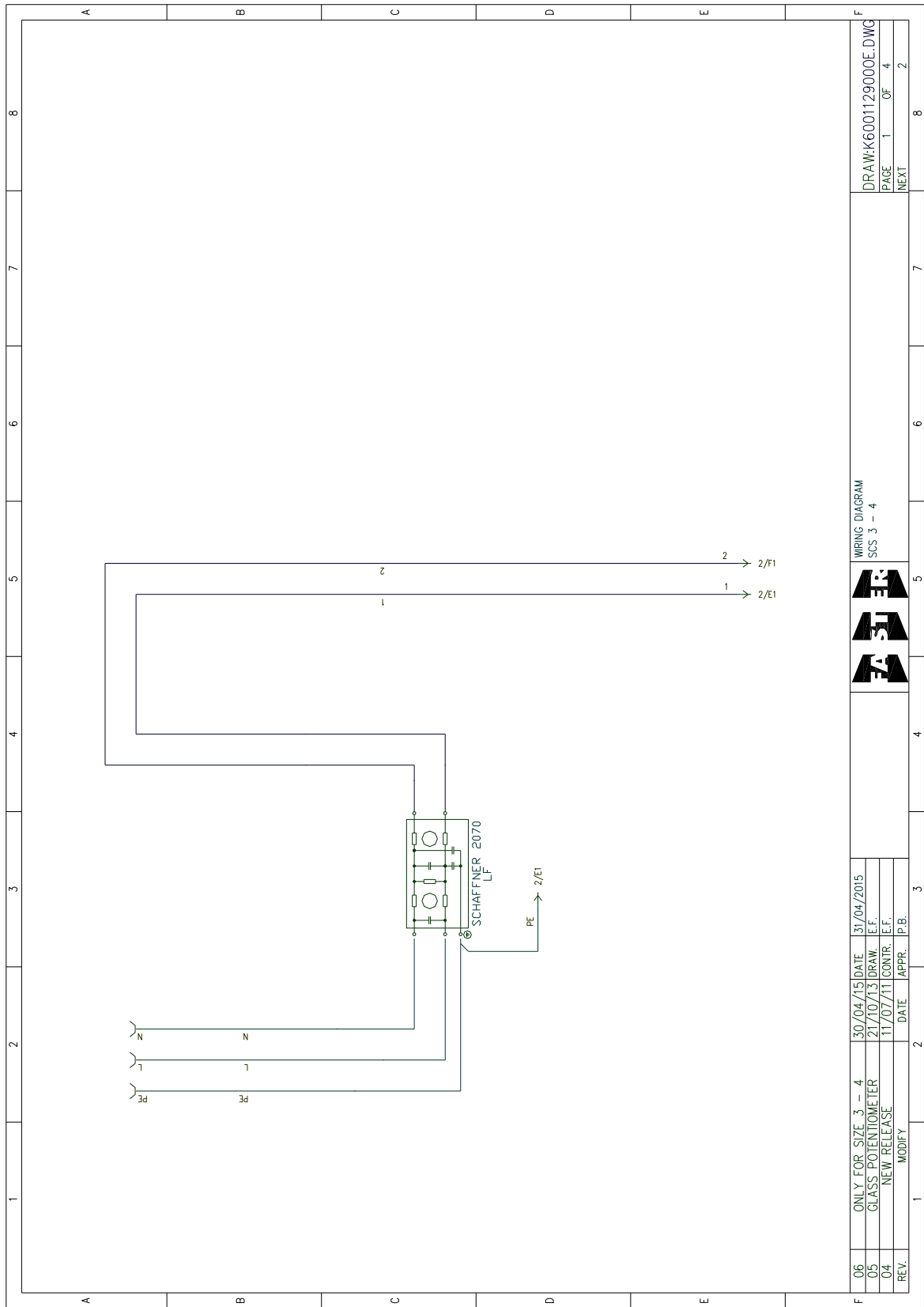

06	ONLY FOR SIZE 3 - 4	30/04/15	DATE	31/04/2015	DATE	DRAW:K6001129000E.DWG	
05	GLASS POTENTIOMETER	21/10/13	DRAW.	E.F.	PAGE 1 OF 4		
04	NEW RELEASE	11/07/11	CONTR.	E.F.	NEXT 2		
REV.	MODIFY	DATE	APPR.	P.B.			
				1	2	3	4
				5	6	7	8
				WIRING DIAGRAM			
				SCS 3 - 4			

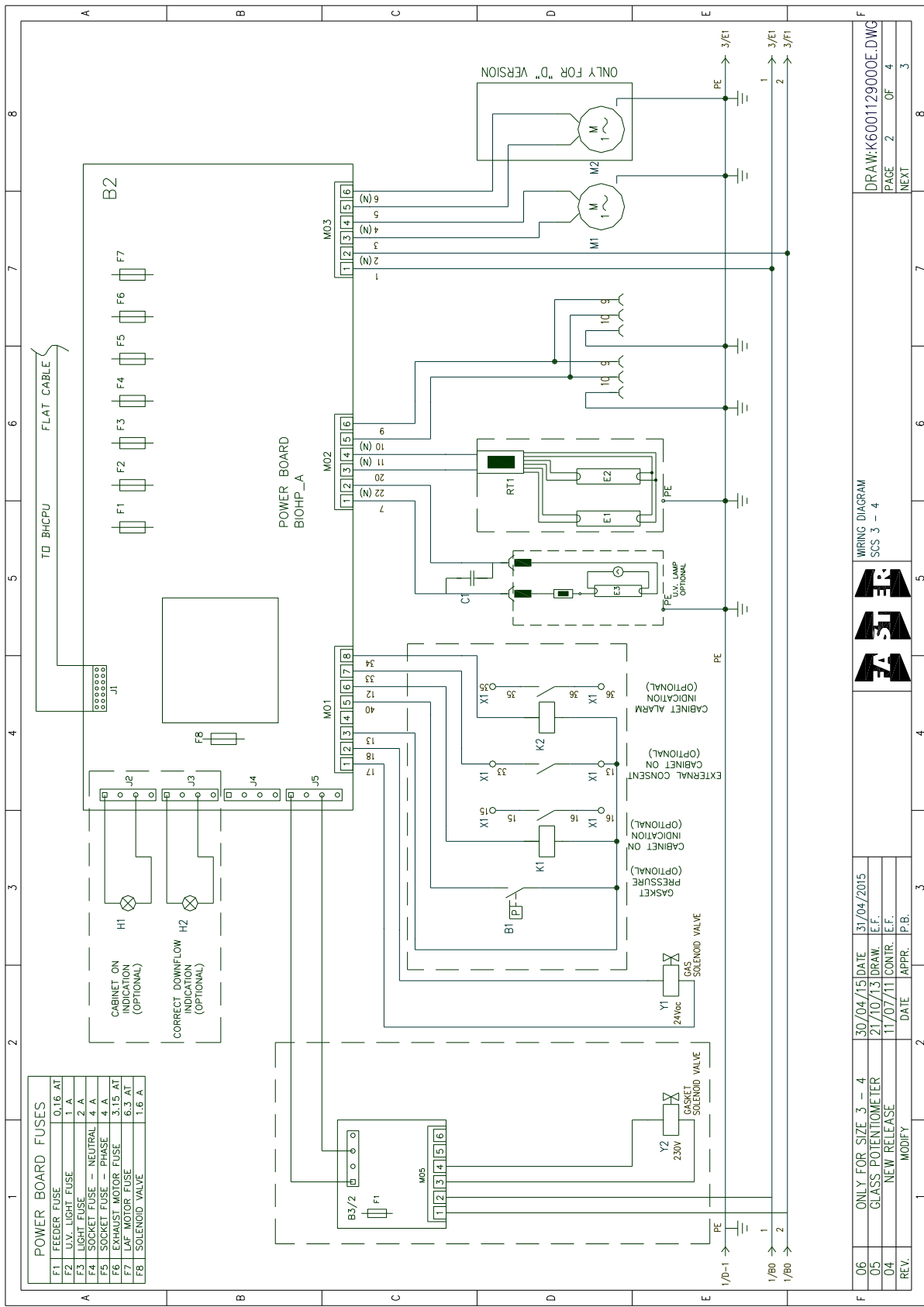

POWER BOARD FUSES

F1	FEEDER FUSE	0.16 AT
F2	U.V. LAMP FUSE	2 A
F3	U.V. LAMP FUSE	2 A
F4	SOCKET FUSE - NEUTRAL	4 A
F5	SOCKET FUSE - PHASE	4 A
F6	EXHAUST MOTOR FUSE	3.15 AT
F7	LAF MOTOR FUSE	6.3 AT
F8	SOLENOID VALVE	1.6 A

06	ONLY FOR SIZE 3 - 4	30/04/15	DATE	31/04/2015
05	GLASS POTENTIOMETER	21/10/13	DRAW.	E.F.
04	NEW RELEASE	11/07/11	CONTR.	E.F.
REV.	MODIFY	DATE	APPR.	P.B.

WIRING DIAGRAM		DRAW:K6001129000E.DWG	
SCS 3 - 4	PAGE 2	OF 4	
	NEXT	3	

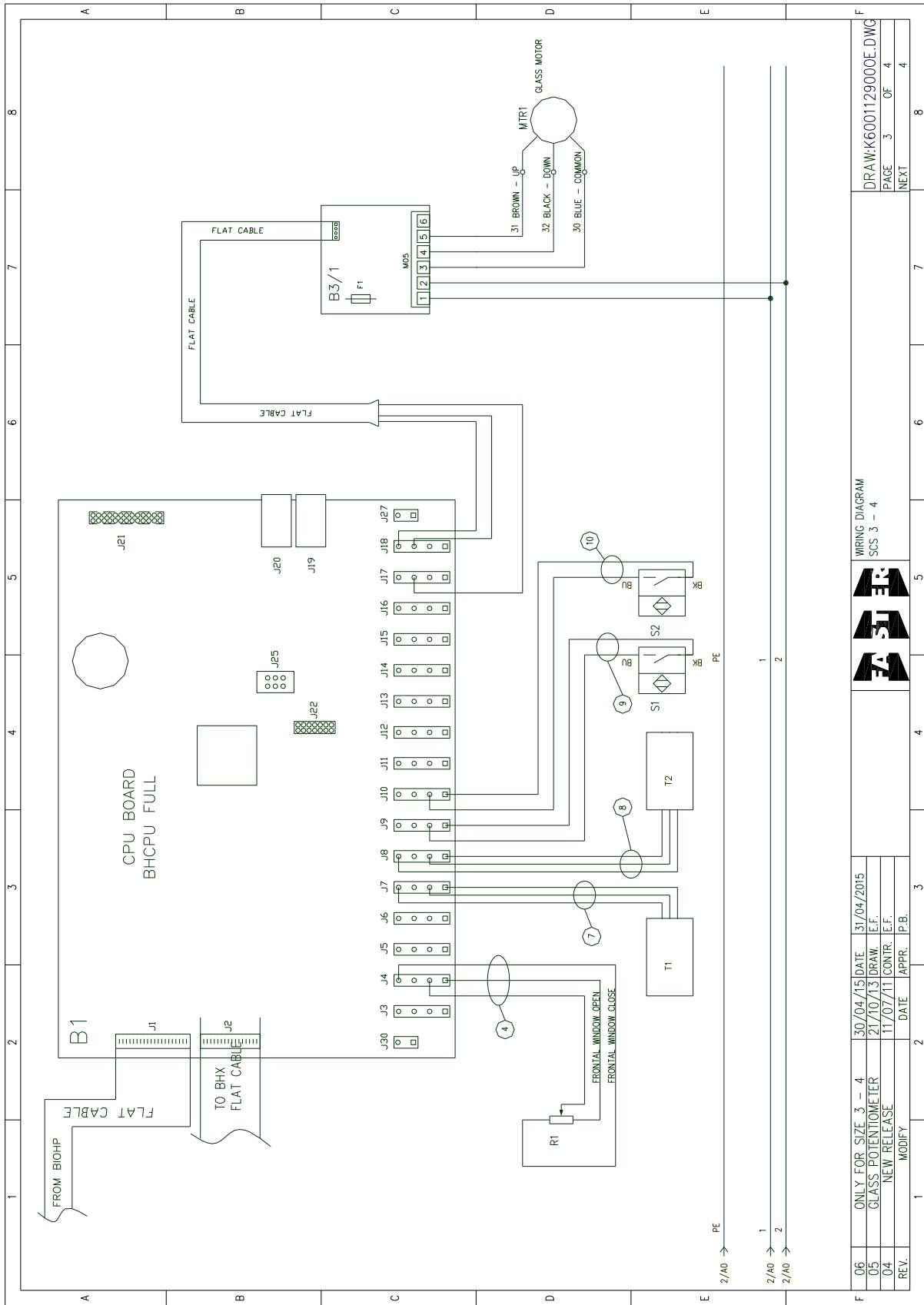

INITIALS	DESCRIPTION	QUANTITY	SCS 3 I/II	SCS 4 I/II	NOTE
T1	INTERNAL TEMPERAT. SENSOR	1			
T2	EXTERNAL TEMPERAT. SENSOR	1			
S1	LAF MOTOR PROXIMITY	1	AEG 8/2	AEG 8/2	
S2	EXHAUST MOTOR PROXIMITY	1	AEG 8/2	AEG 8/2	
R1	WINDOW POTENTIOMETER	1	10kΩ	10kΩ	
F1	FEEDER FUSE	1	0.16 AT	0.16 AT	DIM. 5 X 20
F2	U.V. LIGHT FUSE	1	1 A	1 A	DIM. 5 X 20
F3	LIGHT FUSE	1	2 A	2 A	DIM. 5 X 20
F4	INTAKE FUSE - PHASE	1	4 A	4 A	DIM. 5 X 20
F5	INTAKE FUSE - NEUTRAL	1	4 A	4 A	DIM. 5 X 20
F6	EXHAUST MOTOR FUSE	1	3.15 AT	3.15 AT	DIM. 5 X 20
F7	LAF MOTOR FUSE	1	6.3 AT	6.3 AT	DIM. 5 X 20
F8	ELECTRIC VALVE FUSE	1	1.6 A	1.6 A	DIM. 5 X 20
F1 (B3/1)	WINDOW MOTOR FUSE	1	1.6 A	1.6 A	DIM. 5 X 20
F1 (B3/2)	INFLATABLE GASKET FUSE	1	1.6 A	1.6 A	DIM. 5 X 20
E1	NEON TUBE	1	30 W	36 W	TYPE G13
E2	NEON TUBE	1	30 W	36 W	TYPE G13
E3	NEON TUBE U.V.	1	15 W	15 W	OPTIONAL
M1	LAF MOTOR	1	DDM 9/7-300 W	DDM 9/9-300 W	
M2	EXHAUST MOTOR	1	DDM 133/190	DDM 133/190	ONLY "D" VERSION
MTR1	WINDOW MOTOR	1			
Y1	ELECTRIC VALVE	1	24 V c.a.	24 V c.a.	
C	CAPACITOR	1	4 microF 450 V	4 microF 450 V	
B1	CPU BOARD	1	BHCPU_C	BHCPU_C	
B2	POWER BOARD	1	BIOHP_A	BIOHP_A	
B3/1	WINDOW MOTOR BOARD	1	NBHG_A	NBHG_A	
B3/2	GASKET BOARD	1	NBHG_A	NBHG_A	OPTIONAL
LF	LINE FILTER	1	FN2070A-10-06	FN2070A-10-06	
Y2	GASKET ELECTRIC VALVE	1	230 V c.a.	230 V c.a.	OPTIONAL
K1	12 V DC MY3 RELAY	1	12 V d.c.	12 V d.c.	OPTIONAL
K2	12 V DC MY3 RELAY	1	12 V d.c.	12 V d.c.	OPTIONAL

WIRING DIAGRAM
SCS 3 - 4



REV. 06	ONLY FOR SIZE 3 - 4	DATE	31/04/2015
05	GLASS POTENTIOMETER	DATE	21/10/13
04	NEW RELEASE	CONTR.	E.F.
REV.	MODIFY	APPR.	P.B.

DRAW: K6001129000E.DWG
PAGE 4 OF 4
NEXT

18.B SCS 5 – 6 (230V 50Hz)

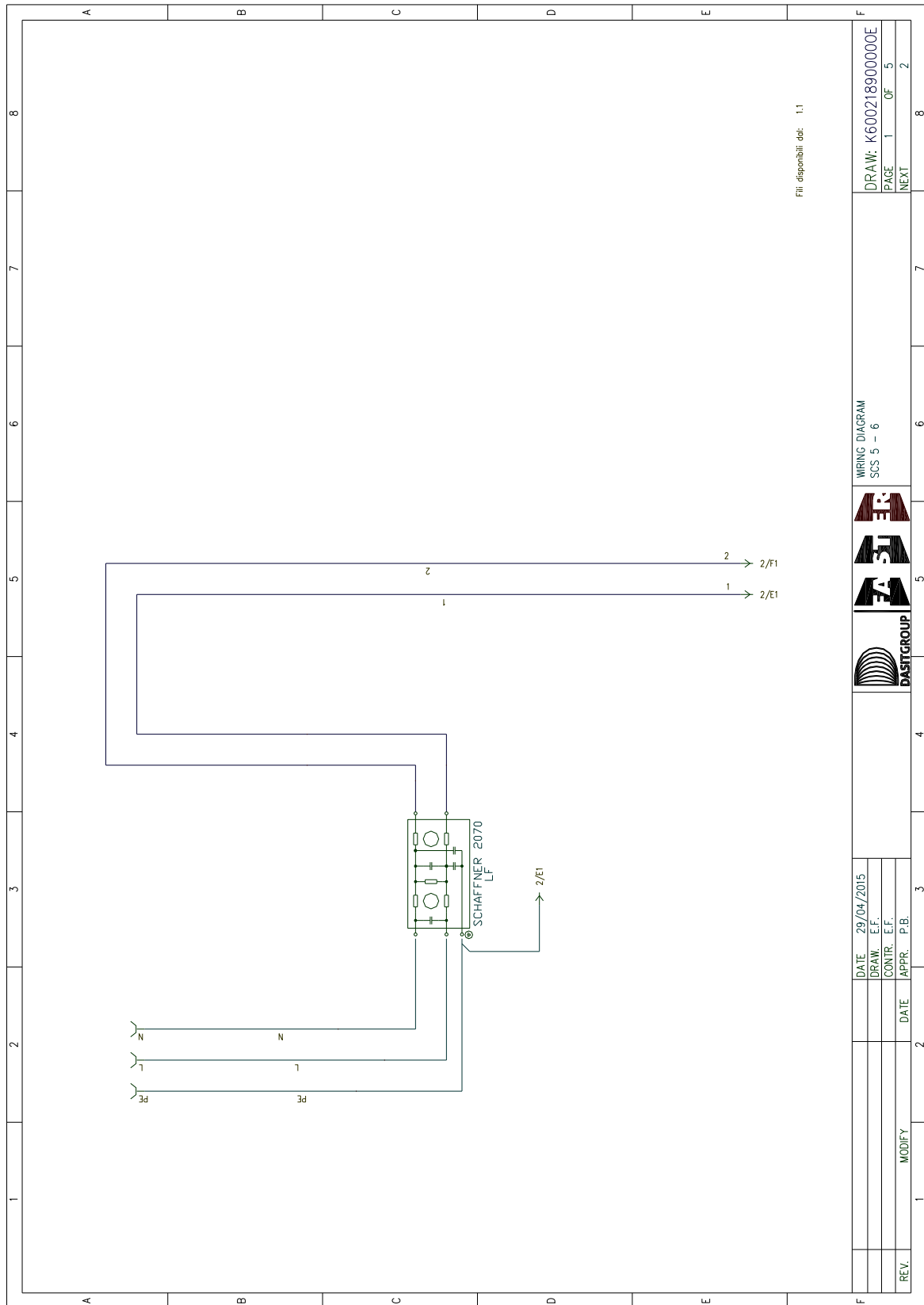

DATE	29/04/2015		
DRAW.	E.F.		
CONTR.	E.F.		
APPR.	P.B.		
REV.	1	MODIFY	2
DATE			
DATE			
APPR.			
P.B.			
WIRING DIAGRAM		SCS 5 - 6	
DRAW:	K600218900000E		
PAGE	1	OF	5
NEXT			2
			8

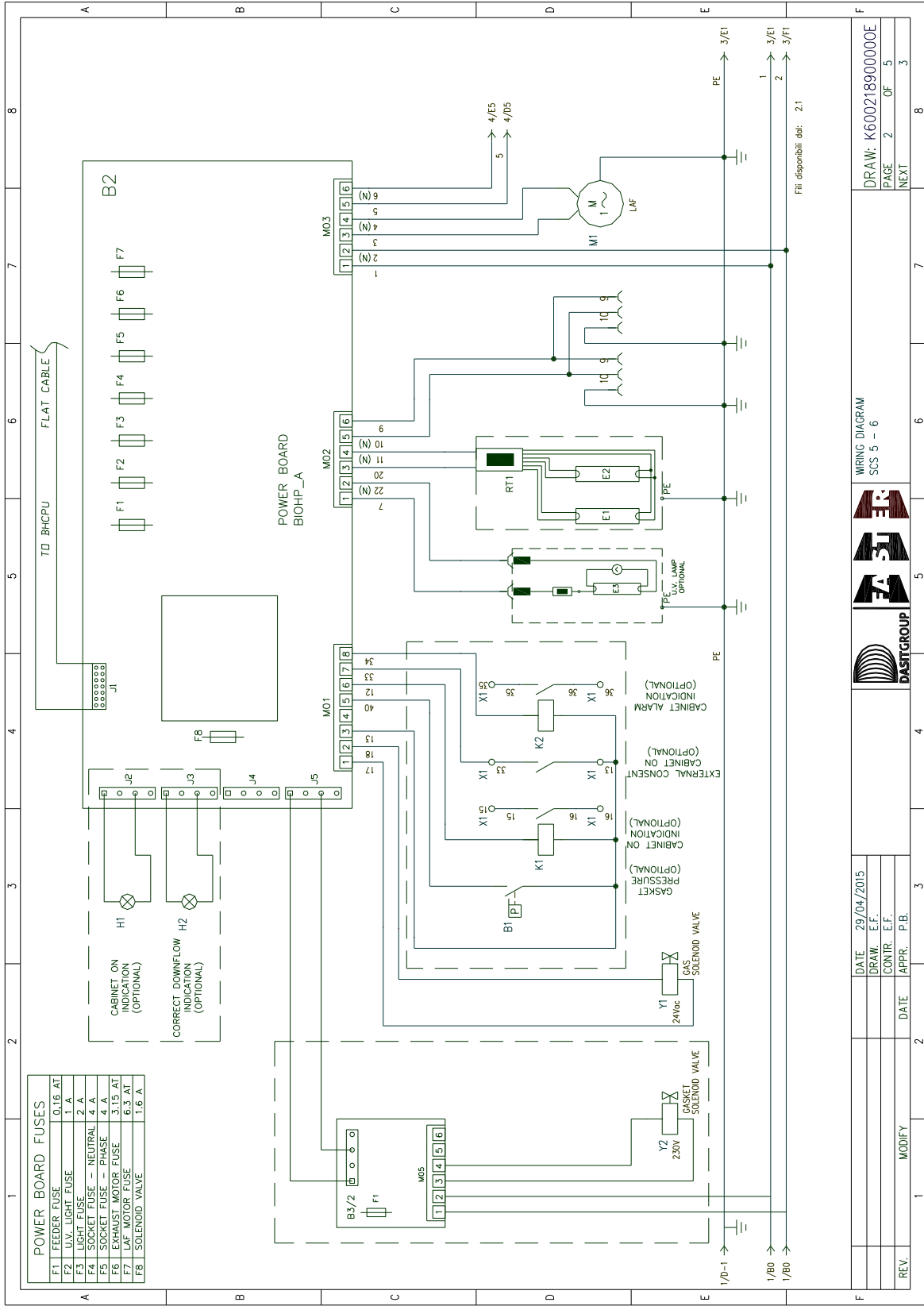

POWER BOARD FUSES	
F1 FEEDER FUSE	0.16 AT
F2 U.V. LIGHT FUSE	1 A
F3 LOGIC FUSES - NEUTRAL	2 A
F4 LOGIC FUSES - PHASE	4 A
F5 EXHAUST MOTOR FUSE	3.15 AT
F6 LAF MOTOR FUSE	6.3 AT
F7 SOLENOID VALVE	1.6 A

DATE: 29/04/2015
 DRAW: E.F.
 CONTR: E.F.
 DATE: _____
 APPR: P.B.

REV. 1 MODIFY
 2
 3
 4
 5
 6
 7
 8

WIRING DIAGRAM
 SCS 5 - 6

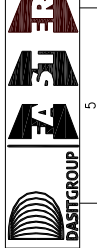

DRAW: K600218900000E
 PAGE 2 OF 5
 NEXT

Fili disponibili: dti: 2.1

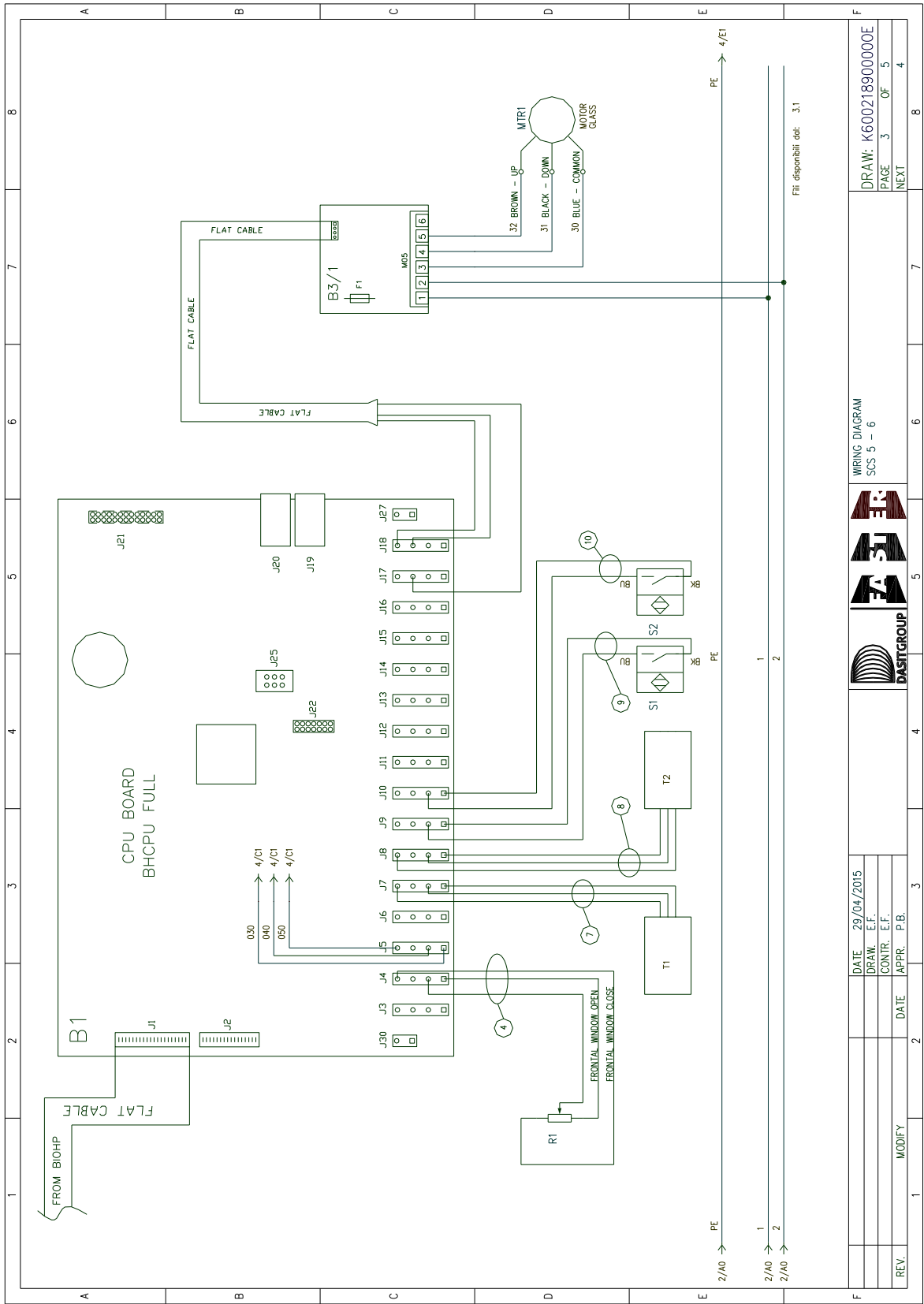

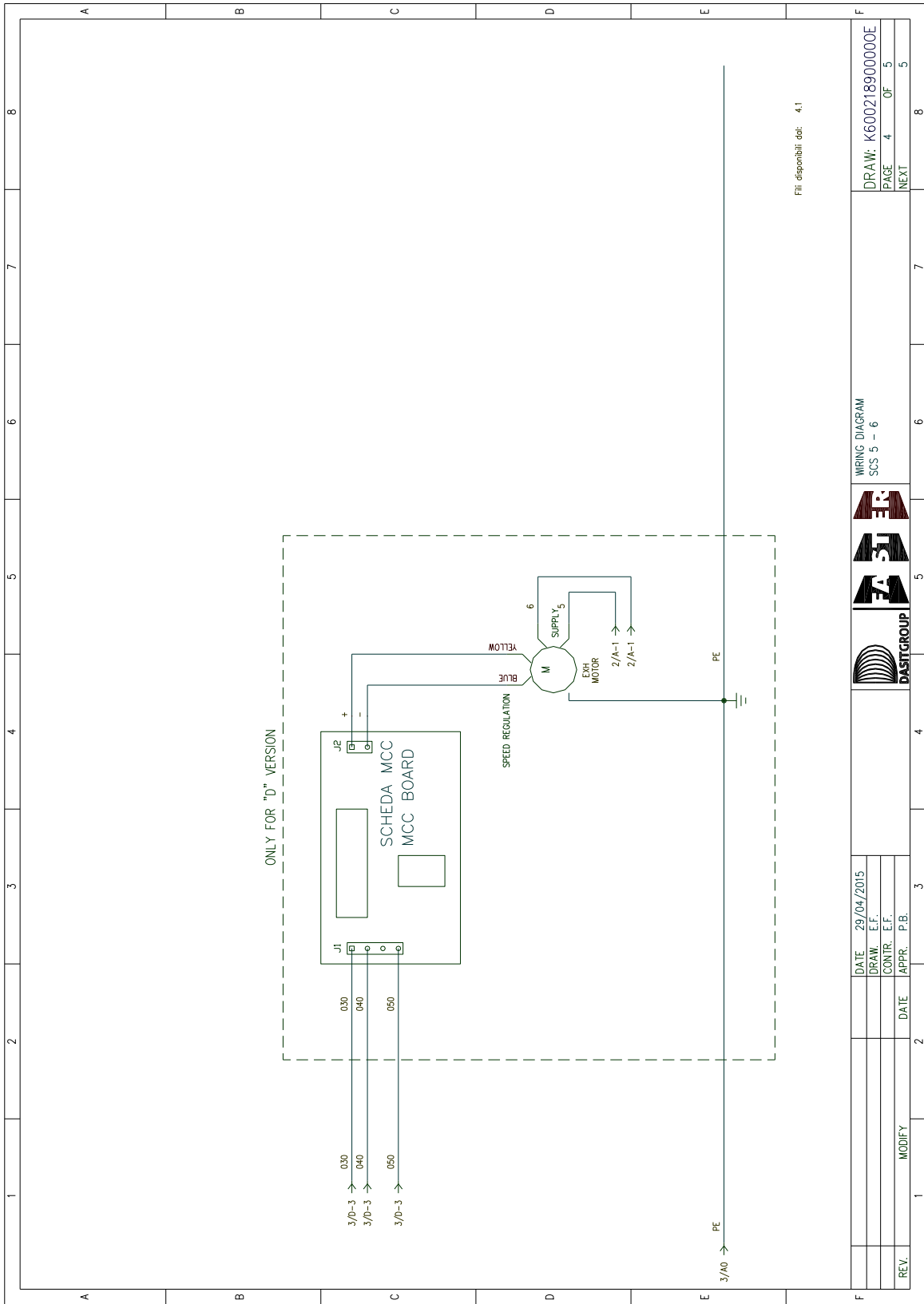

DATE 29/04/2015
 DRAW. E.F.
 CONTR. E.F.
 APPR. P.B.

WIRING DIAGRAM
 SCS 5 - 6



DATE 29/04/2015
 DRAW. E.F.
 CONTR. E.F.
 APPR. P.B.

REV.	MODIFY	DATE

DRAW: K600218900000E
 PAGE 4 OF 5
 NEXT

18.C SCS (110V 60Hz)

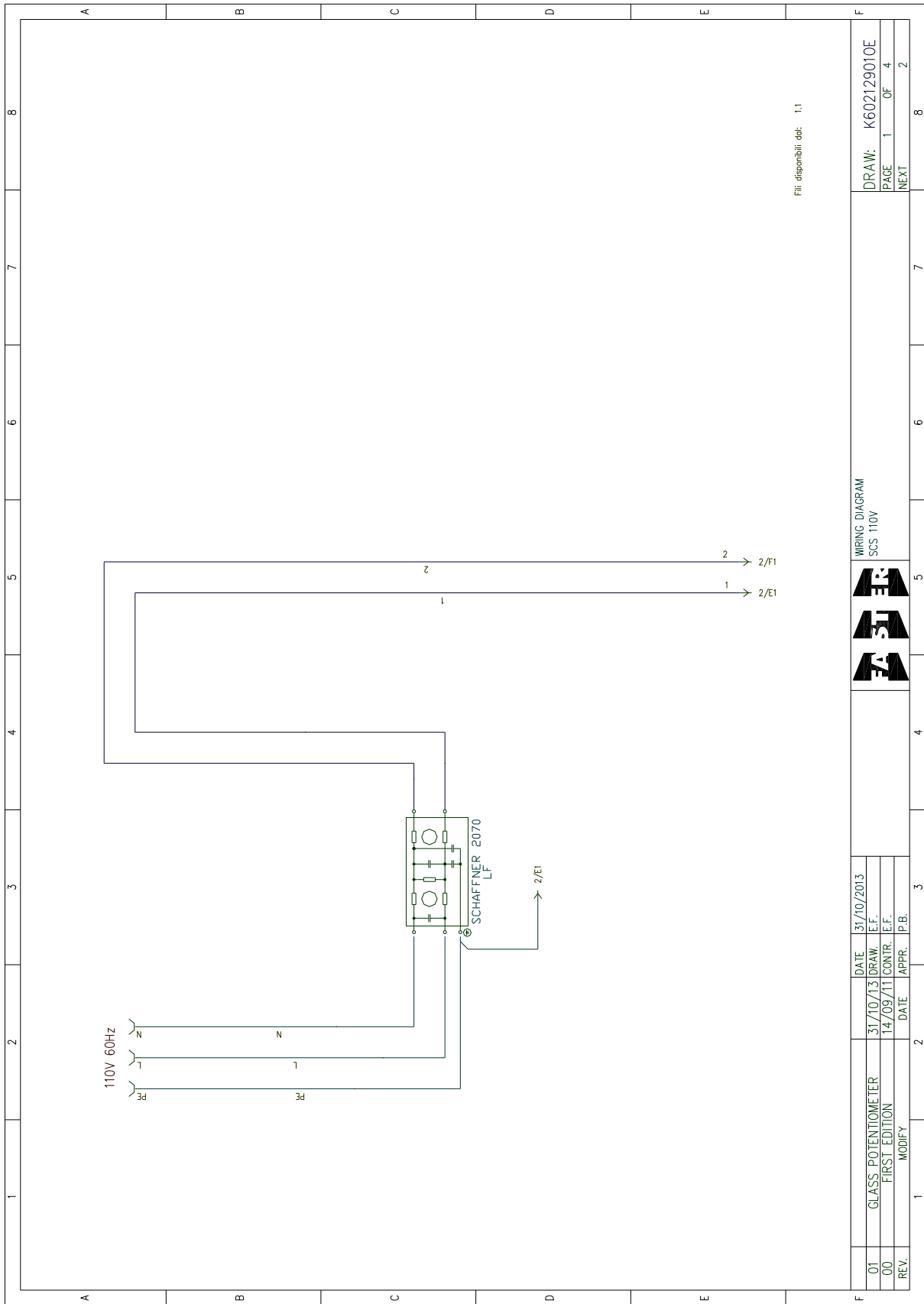

WIRING DIAGRAM
SCS 110V



DRAW: K602129010E
PAGE 1 OF 4
NEXT 2

REV.	DATE	DATE	DATE	DATE	DATE
01	GLASS POTENTIOMETER	31/10/13	31/10/2013		
00	FIRST EDITION	14/09/11			
	MODIFY				

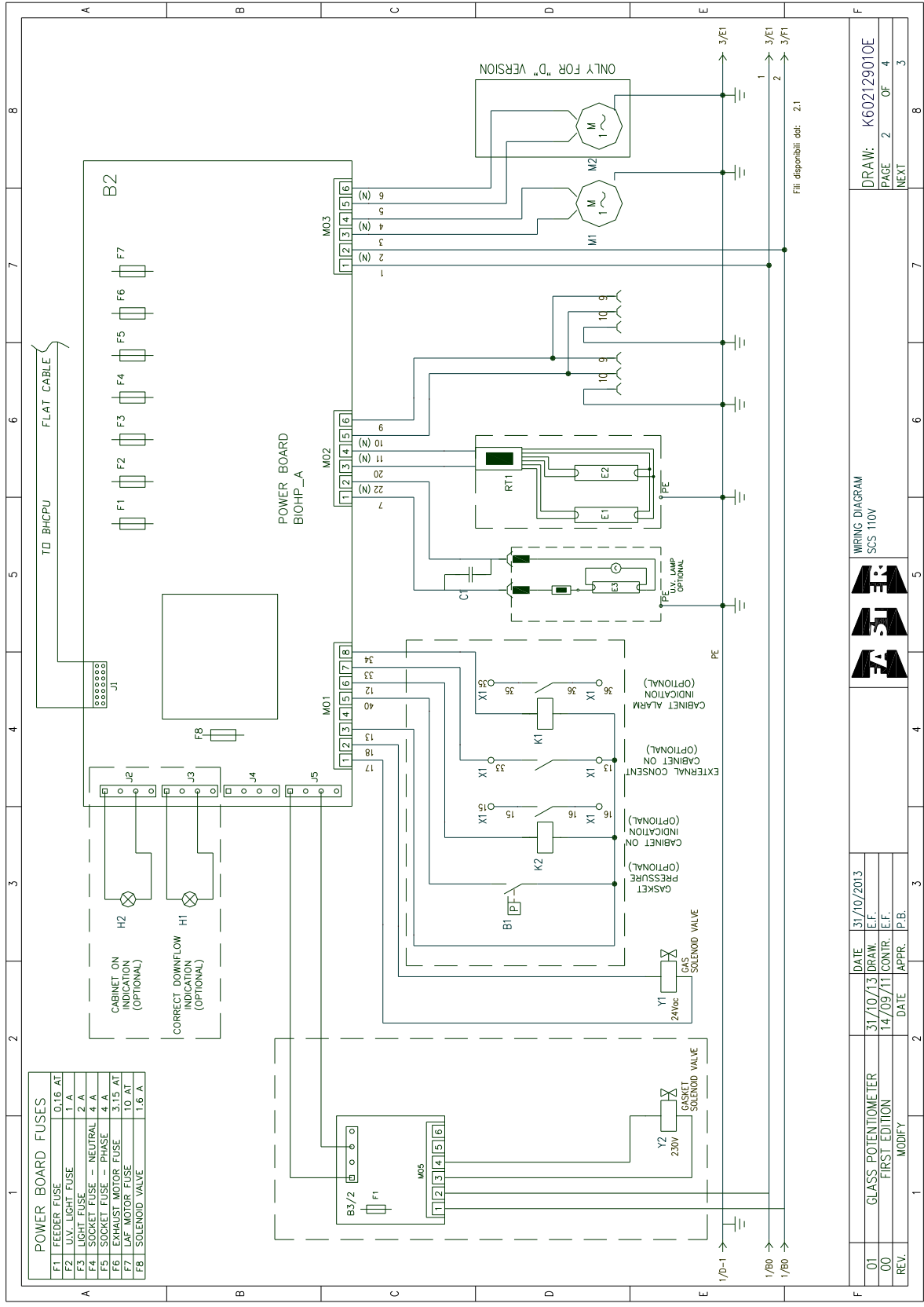

Fili disponibili: idt 2.1

01	GLASS POTENTIOMETER	DATE	31/10/2013
00	FIRST EDITION	31/10/13	DRAW. I.E.F.
REV.	MODIFY	14/09/11	CONTR. I.E.F.
		DATE	APPR. I.P.B.

WRING DIAGRAM
SCS 110V

DRAW: K602129010E
PAGE 2 OF 4
NEXT 3

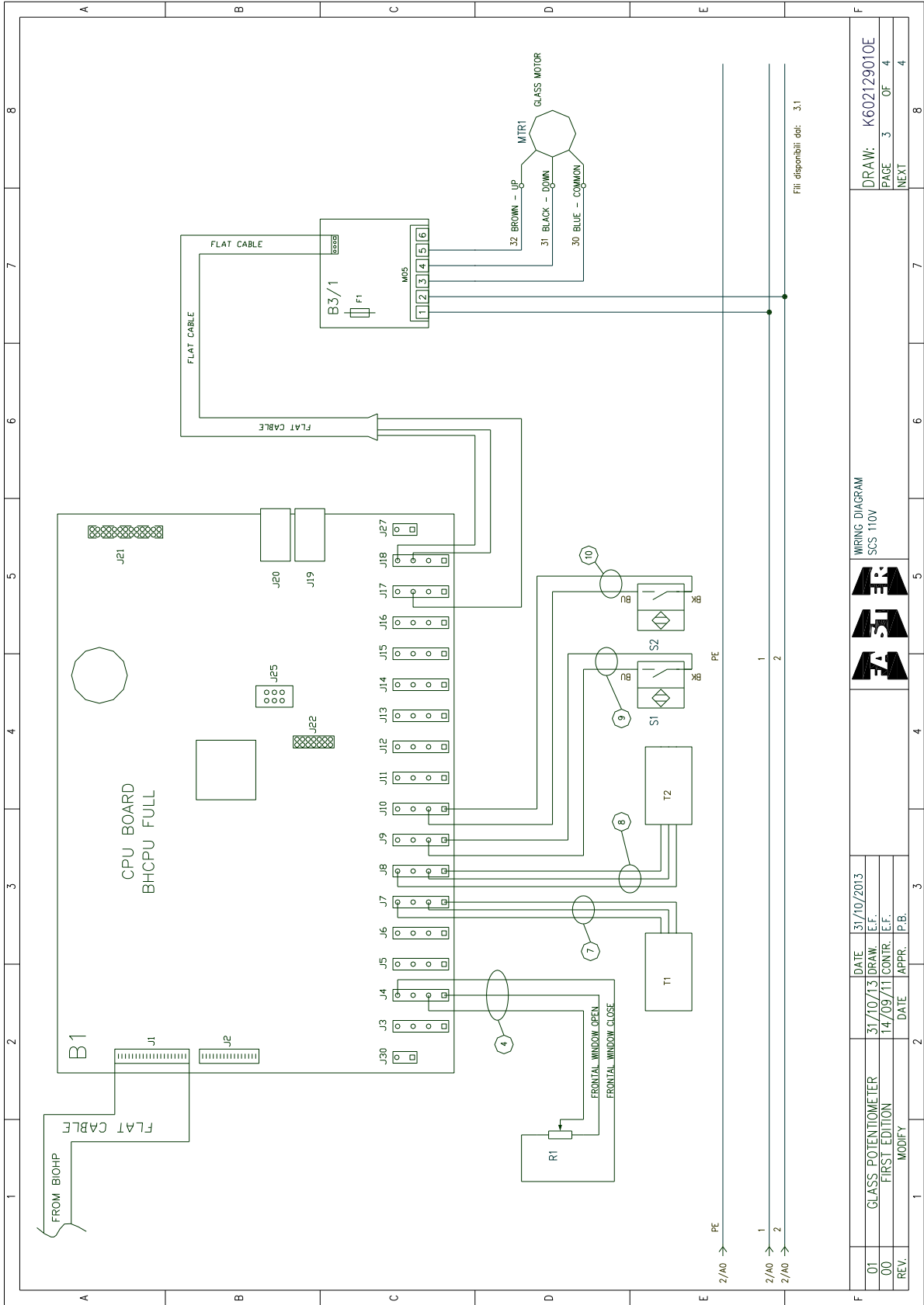

File disponibil: 3.1

01		GLASS POTENTIOMETER	DATE	31/10/2013	WIRING DIAGRAM		DRAW: K602129010E	
00		FIRST EDITION	31/10/13	DRAW	E.F.	SCS 110V		PAGE 3 OF 4
REV.		MODIFY	14/09/11	CONTR.	E.F.	FA SUI ER		NEXT 4
			DATE	APPR.	P.B.			

19 DECLARATION OF CONFORMITY

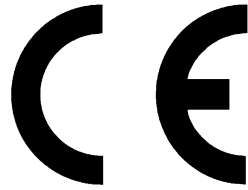

The undersigned legal representative of the company ENVAIR. hereby declares that the follow products:

SCS

are in compliance with the following directives:

2006/42/EC	Directive of the European Parliament and of the Council on machinery
2014/30/UE	Directive of the European Parliament and of the Council on the approximation of the laws of the Member States relating to electromagnetic compatibility
2014/35/UE	Directive of the European Parliament and of the Council on the harmonisation of the laws of Member States relating to electrical equipment designed for use within certain voltage limits
2011/65/EU	Restriction of the use of certain hazardous substances in electronic equipment
2009/125/EU	Establishing a framework for the setting of ecodesign requirements for energy-related products

and with the following standards:

EN 12469	Biotechnology: performance criteria for microbiological safety cabinets
EN 61010-1	Safety requirements for electrical equipment for measurement, control and laboratory use Part 1: general requirements
EN 61326-1	Electrical equipment for measurement, control and laboratory use EMC requirements

and, according to the above-mentioned directives, the CE IIA mark has been applied.

The undersigned also declares that the person who is authorised to compile the relevant technical documentation is Ing. Pietro Bascapè.

Cornaredo, November 7, 2016

ENVAIR.

Maria Giulia Turzi
Chairman of the board