

Operating Instructions TissueLyser

Retsch[®]



Notes on the operating instructions

These operating instructions for the type TissueLyser provide all the necessary information on the topics named in the table of contents.

They act as a guide for the defined target group(s) in the relevant fields towards the safe and correct procedures for handling the TissueLyser. Safe and correct handling is only possible when the relevant target group(s) are familiar with the chapters concerned.

This technical documentation constitutes both a reference work and a tutorial. The individual chapters are self-contained units.

These operating instructions do not contain any instructions on repairs. Should any repairs become necessary, please contact your local supplier or contact

Retsch GmbH & Co. KG www.retsch.de
Qiagen GmbH www.qiagen.com

Notes on the operating instructions	2
Safety	4
Notes on safety	4
Warning notes.....	5
Repairs	5
Confirmation.....	5
Technical Data	6
Use for the intended purpose	6
Safety systems	7
Description of function	7
Drive	7
Vibration frequency of the grinding jar fastening	7
Power rating	7
Emissions	7
IP rating.....	7
Dimensions.....	7
Installation area required	7
Transport and installation	8
Packaging.....	8
Transport	8
Temporary storage	8
Scope of supply.....	8
Parameters for the installation point	8
Installation	9
Electrical connection	9
Operation	10
Controls and operation.....	10
Graphical display of the controls:	10
Table of controls	11
Clamping with the ratchet fastening.....	12
Racks and adapters	13
Switching on / off	14
Setting the time	14
Setting the frequency	14
Programming the TissueLyser	15
Calling up a program	15
Starting, pausing, stopping.....	15
Adjustment lockout.....	16
Changing fuses	16
Notes on operation.....	17
General	17
Cleaning.....	17
Maintenance	17
Necessary safety tests	17
Copyright	18
Modifications.....	18
Troubleshooting list	18
Safety regulations (table).....	19
Warranty Conditions	20

Safety

Target group: All persons dealing with the machine in any way.

The TissueLyser is a highly modern, efficient product from Retsch GmbH. Its engineering is state of the art. When handled correctly by persons familiar with this technical documentation, the TissueLyser is perfectly safe and reliable in operation.

Notes on safety

You, as the operator, are responsible for ensuring that the persons appointed to work with the TissueLyser

- have read and understood all the regulations concerning safety,
- are familiar with all procedures and instructions for their relevant target group before starting work,
- have access to the technical documentation for this machine at all times and without difficulty.

You should ensure that new personnel are instructed in safe and correct handling, either orally by a competent person and/or using this technical documentation, before starting work with the TissueLyser.

Incorrect operation can lead to damage or injury. You are responsible for your own safety and that of your staff.

Please ensure that no unauthorised persons have access to the TissueLyser.



For your own protection, have your staff confirm that they have been instructed in the operation of the TissueLyser. You will find an appropriate draft form at the end of the chapter on safety.



We accept no liability whatsoever for any damage or injury resulting from non-observance of the following notes on safety.

Warning notes

We use the following signs to warn you against:

	Personal injury
	Damage to property

Repairs

These operating instructions do not contain any instructions on repairs. For your own safety, only have repairs performed by Retsch GmbH or by an authorised representative (service technicians).

In such cases, please notify:

The Retsch agency in your country
Your supplier
Retsch GmbH direct

Your service address:

Confirmation

I have read and noted the chapters entitled Foreword and Safety

Operator's signature

Service technician's signature

Technical Data

Machine type designation: TissueLyser

Use for the intended purpose

The TissueLyser is the first laboratory vibration mill to allow a high-throughput scale cell analysis to be performed with the adapters exclusively available from QIAGEN GmbH. The adapters allow Collection Microtube racks (for 96 Collection Microtubes) or racks for 3 x 8 test tubes to be fastened in the vibration mill. In this way, when suitable grinding balls are used, 2 x 96 samples (Collection Microtube rack) or 2 x 24 samples (rack for 3 x 8 test tubes) can be broken down in the shortest possible time, so as to permit cleaning of the nucleic acids by the QIAGEN method in an efficient manner.

For information on ordering the adapters and further notes on applications, please contact

QIAGEN GmbH
Max-Volmer-Straße 4
40724 Hilden
Germany
Tel. 02103/29-12400 (Technical Service)
<http://www.qiagen.com>

or the QIAGEN sales office or the distributor in your region.

The TissueLyser Laboratory Vibration Mill is not designed as a production machine, but as a laboratory device intended for 8 hour single shift operation with a continuous duty factor of 30%.

The load on the TissueLyser drive is directly affected by the diameters of the grinding balls, or rather the mass of the grinding balls. The ball mass resulting from the materials and the corresponding ball diameters are the upper limit for the load. When using different ball materials, these masses must not be exceeded!

Use of the max. grinding ball mass in:

Collection-Microtube racks (96 Collection Microtubes) with
1 tungsten carbide ball in each up to max. \varnothing 4mm=0.5g or
1 steel ball in each up to max. \varnothing 5mm=0.5g

Racks for 24 test tubes with
1 tungsten carbide ball in each up to max. \varnothing 5mm=1.0 g

Grinding jars of different volumes and materials are available from Retsch GmbH & Co. KG www.retsch.de



With milling processes using the balls, or rather the ball masses, mentioned above the vibration frequency reachable can, depending on the local variation in the mains voltage, drop to approx. 25 Hz or 1500 oscillations/minute.

For further information, please contact our applications laboratory staff, who will be pleased to help.



Do not modify the machine in any way, and use only spare parts and accessories approved by Retsch.

Otherwise the conformity with European Directives declared by Retsch will be invalidated.

Furthermore, this will lead to all warranty claims being rendered null and void.

Safety systems

The grinding chamber of the TissueLyser laboratory mill is surrounded by a robust cover.

The machine can only be started when the cover is closed.

If the cover is opened before operation has finished, an electrical brake brings the grinding vessels to a standstill in a fraction of a second.

Description of function

The milling process in the TissueLyser laboratory mill is performed by the beating effect of the grinding balls on the process material and the friction between the grinding balls and the walls of the grinding jars.

The grinding jars, positioned horizontally, are subjected to radial oscillations which ensure that the grinding balls impact against the material one after the other.

The speed can be set from 3 - 30 Hz (180 - 1800 oscillations/minute) and is kept constant by a speed controller during operation.

The milling and mixing duration can be preset digitally from 10 sec. to 99 min.; the setting is preserved in standby mode for further operations.

Drive

Single phase AC motor

Vibration frequency of the grinding jar fastening

3 - 30 1/s = 180 - 1800 1/min

Power rating

Approx. 184 VA

Emissions

Noise characteristics:

Noise measurement to DIN 45635-031-01-KL3

The noise levels are also influenced by the properties of the material to be milled.

Example 1 :

Sound power level $L_{WA} = 93$ dB(A)

Workplace related emission level $L_{p_{eq}} = 83.2$ dB(A)

Service conditions:

Vessels= 2 Collection Microtubes racks in an adapter

Milling unit= 13mm stainless steel ball per tube

IP rating

IP40 / IP20 casing aperture for grinding jar fastening

Dimensions

Height: up to approx. 225mm, Width: 300mm, Depth : 470mm

with cover open

Height: up to approx. 410mm, Width: 300mm, Depth : 470mm

Weight: approx. 20 kg without analysis sets

Installation area required

300 mm x 470 mm; no safety clearances are necessary.

Transport and installation

Packaging

The packaging is suitable for the particular means of transport. It complies with the general packaging regulations.



Please keep the packaging for the duration of the guarantee period, as your guarantee claim may be invalidated if there is a complaint and the unit is returned in inadequate packaging.

Transport



The TissueLyser must not be jarred, shaken or thrown during transport. This could damage the electronic and mechanical components.

Temperature fluctuations



When subjected to major temperature fluctuations (e.g. during air transport) the TissueLyser is to be protected from condensation. Damage to the electronic components may otherwise result.

Temporary storage

Ensure that the TissueLyser is stored in a dry place even when storage is temporary.

Scope of supply

- TissueLyser
- 1 power cable
- 1 instruction manual

Check that the delivery is complete, including any accessories ordered in addition.

Check that the TissueLyser functions perfectly (see the chapter on operation).



In cases of incomplete delivery and/or transport damage, you must notify the forwarding agent and Retsch GmbH without delay (within 24 hours). It may not be possible to accept complaints later.

Parameters for the installation point

Ambient temperature:

5 °C to 40 °C



If the ambient temperature is above or below that specified, the electrical and mechanical components may be damaged and performance data may change to an unknown extent.

Humidity:

Maximum relative humidity 80% at temperatures up to 31 °C, declining in a straight line to 50% relative humidity at 40 °C



Higher humidity can cause damage to the electrical and mechanical components, and performance data can change to an unknown extent.

Site altitude:

Max. 2000 m above sea level

Installation

Always set the TissueLyser on a firm base.

Remove the braces fitted for transport:

Two such braces **P** are located on the bottom of the TissueLyser. **Fig.1** They are marked by arrows.

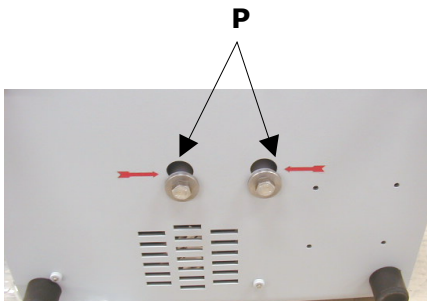

Fig.1

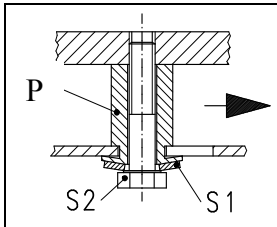
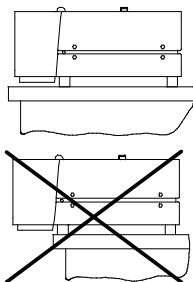

Fig.2

- Loosen bolts **S2**, see **Fig.2**
- Loosen the bolts **S2** of the transport brace **P** with washer **S1** by shifting the slot and removing it
- Keep the braces for use if the machine will have to be transported again.



If the machine is operated **with** the transport braces still in place or transported with the braces **not** in place,
mechanical components may be damaged.



The machine must be positioned fully on the laboratory bench. Its cover must not project over the front of the bench.

Otherwise, it may be possible to reach into the machine.

Danger of injury to the hands!

Electrical connection

- See the type plate for the voltage and frequency of the TissueLyser.
- Ensure that the values agree with those of the available power supply.
- Connect the TissueLyser to the power supply using the power cable supplied.



Failure to observe the values on the type plate can lead to damage to electrical and mechanical components.

Operation

Target group: Operators

Controls and operation

Graphical display of the controls:

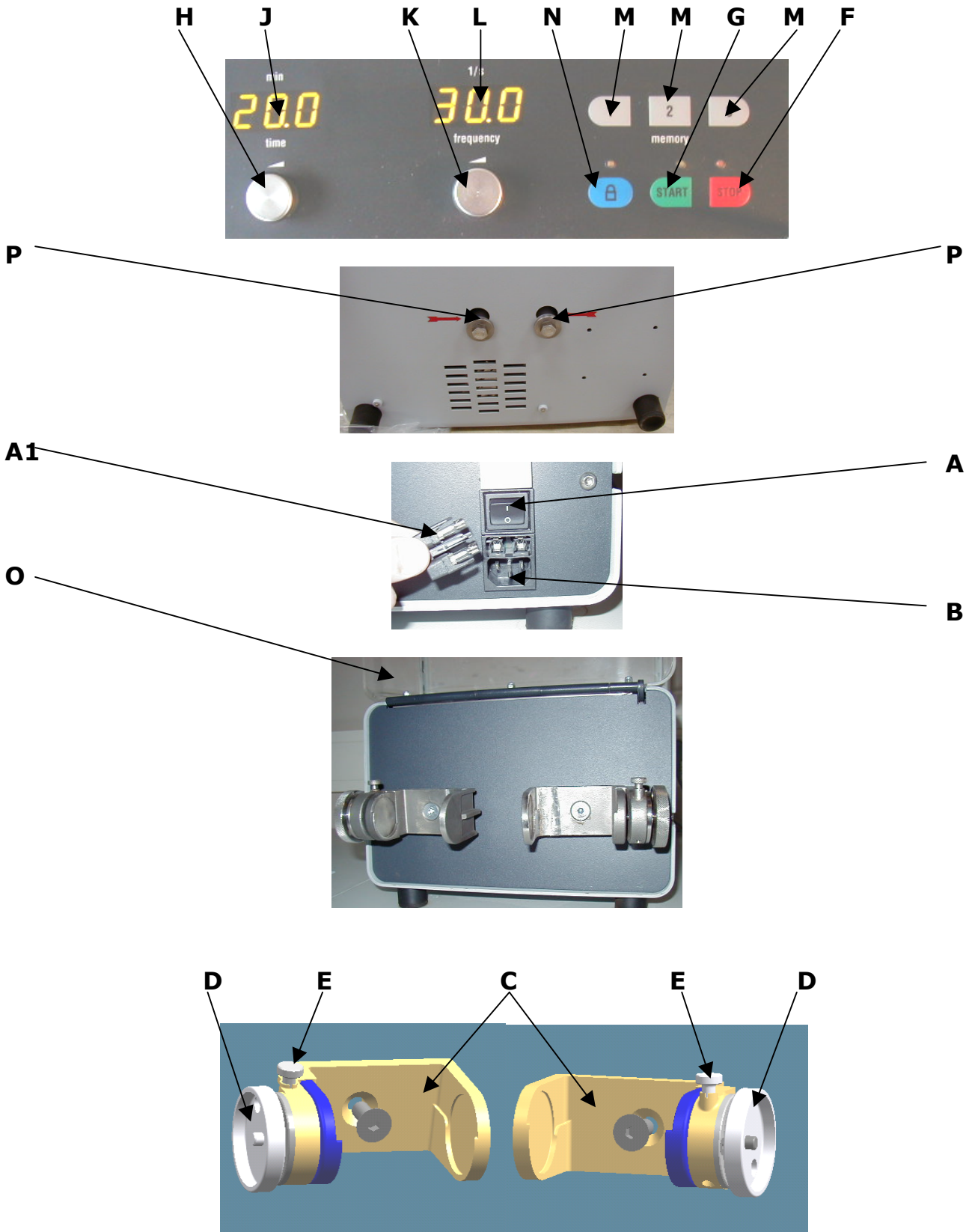
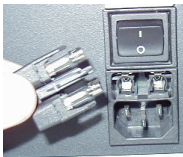
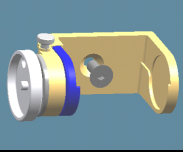
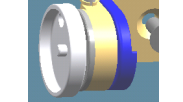
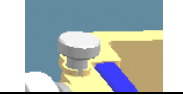

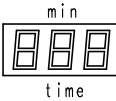

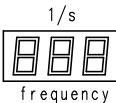

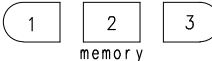



Table of controls

Item	Element	Illustration	Function
A A1 B	main switch fuse tray Power socket		Connects the TissueLyser to, and isolates it from, the mains Accommodates the mains cable
C	Ratchet fastening		Accommodates the corresponding adapter
D	Hand wheel with compression disk		Clamps the adapter
E	Locking bolt		Secures against unintended loosening of the hand wheel
F	START button		Starts the grinding process LED lights up Access to adjustment mode
G	STOP button		Stops the grinding process before the set time has expired. LED lights up Press the STOP button a second time = standby Access to pause function
H	Display of machine running time		Indicates the pre-selected running time from 10 sec. to 99 min
J	Rotary knob for time setting		Facilitates programming of the desired running time.
L	Frequency display		Displays the pre-selected frequency and the operating frequency.
K	Rotary knob for frequency display		Regulates motor speed and accordingly the vibration intensity of the grinding jars.
M	Memory function		Facilitates storage and call-up of up to three times and frequency combinations.
N	Adjustment lockout		Prevents adjustment of time and frequency. Press button P to activate the adjustment lockout: the LED will then light up. To deactivate the lockout, press button P in standby mode
O	Plexiglas cover	Not shown	Prevents inadvertent reaching into a running machine
P	Transport brace	Not shown	Protects the internal components of the machine during transport

Clamping with the ratchet fastening

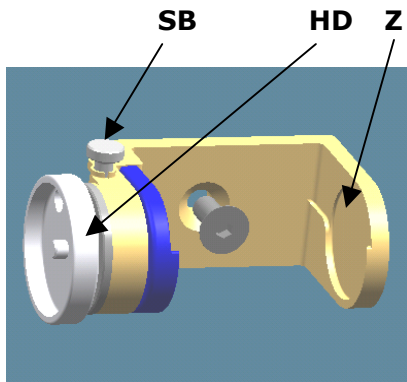

Fig. 1

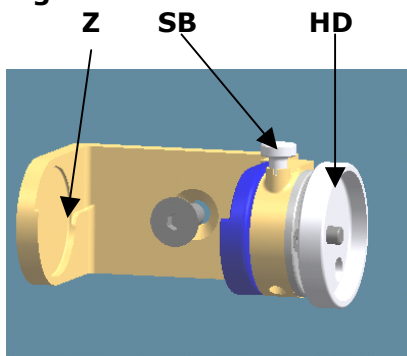

Fig. 2

- Pull up the clamping bolt **SB** out of the groove and rotate it by 90°. **Fig.1/2**

Now the automatic locking is deactivated.

- Turn the hand wheel **HD** counterclockwise until the max. clamping zone is available. **Fig.1/2**
- Rotate clamping bolt **SB** back by 90° until it locks back into the groove.
- Rotate the hand wheel **HD** with two fingers counterclockwise until the grinding jar is held just without play in the fastening. Now the hand wheel is turned clockwise for 8-12 clearly audible "clicks"; the clamping bolt **SB** is raised and lowered when these clearly audible "clicks" are produced.

The locked in clamping bolt safely prevents the unintended opening of the grinding jar fastening.

If the locking pin SB cannot be loosened by pulling upwards, loosening must not be forced by using a hammer or similar tool. Retighten the handwheel HD briefly in a clockwise direction, and the locking pin will then be freely movable again.

Otherwise the hardened locking pin can break off.



Load both ratchet fastenings with approximately the same mass.

Unduly rough running of the TissueLyser can lead to damage of the mechanical and electronic components



If the locking pin SB cannot be loosened by pulling upwards, loosening must not be forced by using a hammer or similar tool. Retighten the handwheel HD briefly in a clockwise direction, and the locking pin will then be freely movable again.

Otherwise the hardened locking pin can break off.

Racks and adapters

Various racks, lids and a base are available for construction of the analysis sets.

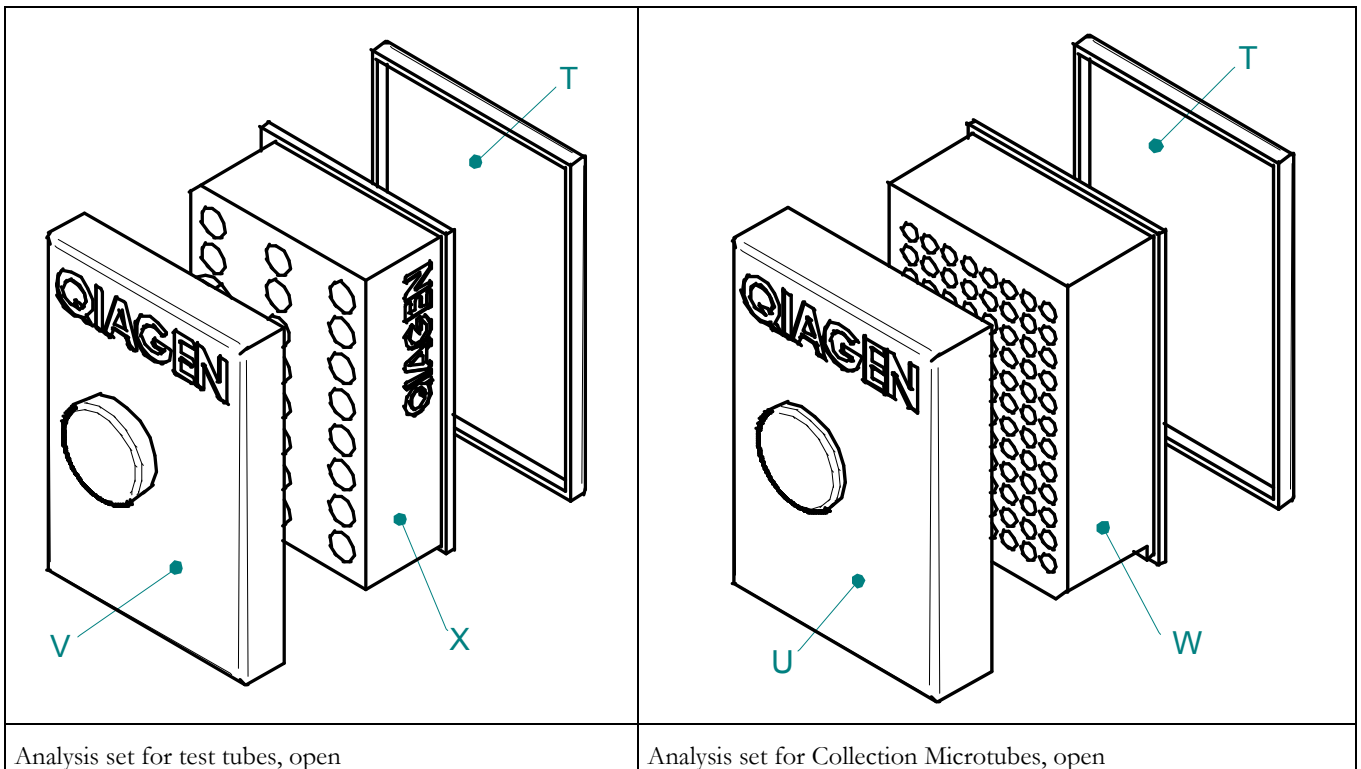
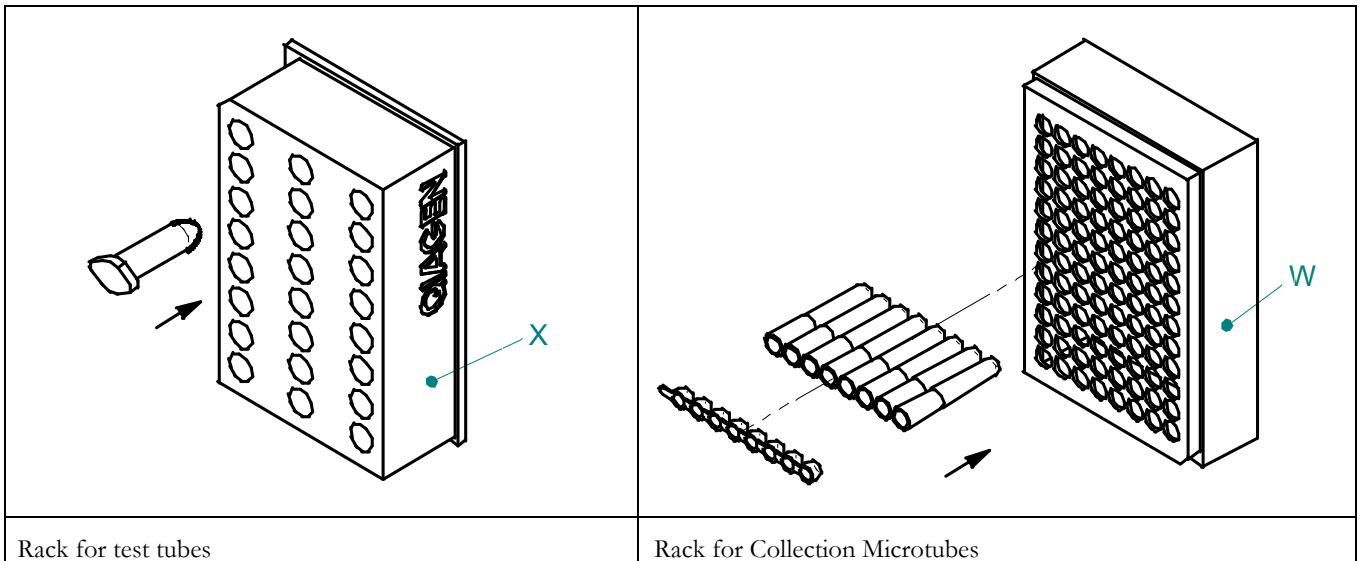

Legend:

- T = Adapter for test tubes and Collection Microtubes
- U = Pressure plate for Collection Microtubes
- V = Pressure plate for test tubes
- W = Rack for Collection Microtubes
- X = Rack for test tubes

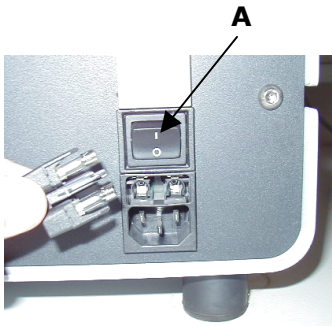

Fig.2

Switching on / off

The main switch **A** is located at the rear of the TissueLyser
Fig.2

- Turn on the main switch **A**.
- The LED above STOP **F** flashes briefly after the machine has been turned on. **Fig.3**
- The **time** display shows the time last set.
- The **frequency** display shows the speed last set.

The TissueLyser is now in programming mode.

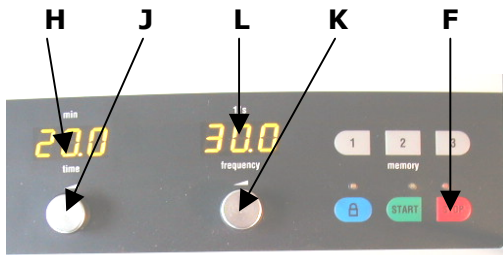

Fig.3

Setting the time

When the TissueLyser is switched on it automatically goes into programming mode. The running time last used is shown on display **H**.

Set time to 10 sec - 99 minutes: Fig.3

- By turning knob **J** counterclockwise you can reduce the time set down to 10 seconds.
- By turning knob **J** clockwise you can increase the time set up to 99 minutes.

Running time can be set freely between 10 sec. and 99 min. From 10 min. onwards, the time can only be set in full minutes.

Turn knob slowly to move in steps of 1 sec. / 1 min.

Turn knob rapidly to move in steps of 30 sec. / 5 min.

Setting the frequency

When the TissueLyser is switched on it automatically goes into programming mode. The frequency last used is shown on display **L**.

Set frequency to 3 - 30 Hz: Fig.3

- By turning knob **K** counterclockwise you can reduce the frequency set down to 3 Hz.
- By turning knob **K** clockwise you can increase the frequency set up to 30 Hz.

The frequency can be set freely between 3 and 30 Hz [1/s].

Turn knob slowly to move in steps of 0.1 Hz [1/s].

Turn knob rapidly to move in steps of 5 Hz [1/s].



The TissueLyser is equipped with an electronic overload indicator.

If there is an overload, the frequency display changes back and forth between the frequency that you have set and the maximum frequency reached.

Lower the frequency to the maximum frequency reached!

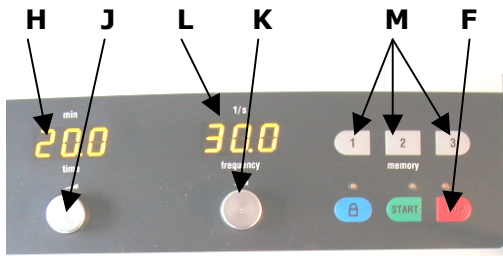

Fig.4

Programming the TissueLyser

The TissueLyser has three memory buttons **M** with which parameter combinations of time and frequency can be saved to memory. **Fig.4**

- Turn the main switch on.
- The LED above the STOP button **F** flashes briefly after the machine has been switched on.
- The displays **H** and **L** indicate the parameters last used.
- Set time using rotary knob **J**.
- Set frequency using rotary knob **K**.
- Keep one of the three memory buttons **M** depressed; after 1.5 seconds displays **H** and **L** will start flashing.
- When the displays stop flashing the parameters have been saved to memory.

Calling up a program

- Press the relevant memory button **M**, **Fig. 4**, briefly. The programmed parameters will be shown on displays **H** and **L**.
- Start the TissueLyser.

Starting, pausing, stopping

Starting: Fig.5

- Press the START button **G**. The green LED above button **G** lights up and the TissueLyser starts up.

Within the set tolerance, the frequency is kept constant while grinding is in progress.

Pause function: Fig.5

- Press the STOP button **F** once. The red LED above button **F** lights up and the values on the displays remain visible.
- Press the START button **G**. Grinding recommences.

Stopping (Standby function) : Fig.5

- Press the STOP button **F** twice. The red LED above button **F** lights up and the **time** and **frequency** displays go out (standby).

Pressing button **G** reactivates the TissueLyser and new parameters can be entered. Then

- press the START button **G** a second time.

The TissueLyser starts up again.

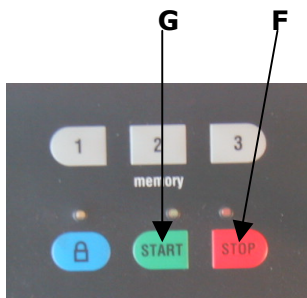

Fig.5

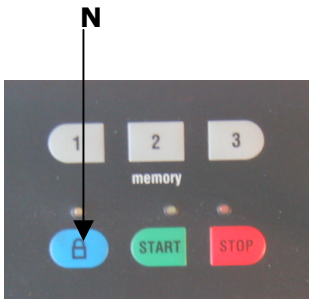

Fig.6

Adjustment lockout

The TissueLyser has an adjustment lockout **N**. Button **N** can be pressed when programming or during operation of the machine. **Fig.6**

- Press the adjustment lockout **N**.
- The LED lights up.

It is now impossible to change the time or frequency settings and no values saved to memory can be called up.

The lockout can only be deactivated by pressing button **N** in standby mode.

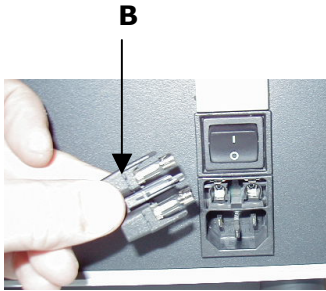

Fig.8

Changing fuses

Two glass fuses (5x20 mm) are required.

2 fuses mT 0.63 A 220-240V/50-60Hz

2 fuses T 2 A 100 / 110 and 120V 50-60Hz

Changing fuses: Fig.8

- Disconnect the mains plug
- Pull out fuse tray **B**
- Replace the fuses
- Slide the fuse tray back in

Notes on operation

General

The TissueLyser is a highly modern, efficient product. The laboratory vibration mill of type TissueLyser has been specially developed for applications in microbiology and molecular biology. It has an adapter system for the clamping of Collection Microtube racks or an adapter for the test tubes from QIAGEN (www.qiagen.com).

Application notes can be taken from the attached Handbook.

Cleaning



Do not clean the TissueLyser under running water.

Danger of fatality from electric shock.

Use a moist cloth only.

Use no organic solvents.

The ingress protection rating of the TissueLyser is IP40 / IP20 (casing aperture for grinding jar fastening).

Maintenance

The TissueLyser is to the greatest possible extent maintenance-free.

When used in accordance with the manufacturer's instructions the machine requires no maintenance or adjustment.

Necessary safety tests

The limit switch and the brake must be checked for correct functioning every six months.

1. Limit switch

- Remove the analysis sets or grinding jars from their fastenings.
- Switch the TissueLyser vibration mill on.
- Set the frequency to 30Hz.
- Start the TissueLyser.
- Open the Plexiglas cover.
- When the Plexiglas cover has been opened by max. 8 mm, measured from the bottom edge of the housing, the motor brake must be activated.
- The motor must not restart when the Plexiglas cover is closed.

2. Brake

- Switch on the TissueLyser vibration mill.
- Set the frequency to 30Hz.
- Switch the TissueLyser vibration mill on.
- Open the Plexiglas cover.
- The brake must act within 1 second.

If the machine fails to behave as described in points **1** and **2** above, contact our service technicians.

Copyright

Dissemination or duplication of this documentation, utilisation and dissemination of its contents will only be permitted with the express approval of Retsch GmbH & Co. KG. Contravention will give rise to liability for damages.

Modifications

The right is reserved to modify any specification without notice.

Troubleshooting list

Fault or error code	Cause	Remedy
LED in button F does not light up.	No mains power	Check external fuses
	Fuses in main switch are defective	Pull out fuse tray and check fuses
	Controller is defective	After sales service
Grinding jar fastening does not move.	Drive belt is loose or broken	After sales service
	Motor is defective	After sales service
F01 = No speed pulses received	Drive is blocked Motor defective Controller defective	Remove block and press STOP button Inform after sales service Inform after sales service
F02 = Speed too high	Hall sensor defective Controller defective	Inform after sales service Inform after sales service
F03 = Braking time too long	Motor brake defective	Inform after sales service
F04	Cover open	Close cover and press STOP button

Safety regulations (table)

for the TissueLyser from the individual chapters

Subject	Action	Hazard
Safety	Failure to observe the notes on safety can lead to damage to property and personal injury.	We accept no liability whatsoever for any damage or injury in this case.
Use for the intended purpose	The sample quantity should not fall below 25 % of the grinding jar volume	Otherwise the grinding balls could damage the grinding jar.
	The materials used for the grinding jar and grinding balls must always be identical.	Otherwise the grinding balls could damage the grinding jar.
	Do not modify the machine in any way, and use only spare parts and accessories approved by Retsch.	Otherwise the conformity with European Directives declared by Retsch will be invalidated. Furthermore, this will lead to all warranty claims being rendered null and void.
	Do not clamp ceramic grinding jars for the MM 2/200 or jars without complete steel jacket.	If clamped in the grinding jar holder of the TissueLyser, the metallic parts can cause damage to the ceramic parts.
Packaging	Please keep the packaging for the duration of the guarantee period.	Your guarantee claim may be invalidated if there is a complaint and the unit is returned in inadequate packaging.
Transport	The TissueLyser must not be jarred, shaken or thrown during transport.	This could damage the electronic and mechanical components..
Temperature fluctuations	When subjected to major temperature fluctuations, the TissueLyser is to be protected from condensation.	Damage to the electronic components may otherwise result.
Scope of supply	In cases of incomplete delivery and/or transport damage, you must notify the forwarding agent and Retsch GmbH without delay (within 24 hours).	It may not be possible to accept later complaints.
Ambient temperature	Not below 5 °C. Not above 40 °C.	Higher humidity can cause damage to the electrical and mechanical components, and performance data can change to an unknown extent..
Humidity	Do not exceed a maximum relative humidity of 80% at temperatures up to 31 °C, declining in a straight line to 50% relative humidity at 40 °C.	Higher humidity can cause damage to the electrical and mechanical components, and performance data can change to an unknown extent.
Transport braces	Remove the transport braces before commissioning. Secure the machine with transport braces when it is to be transported.	If the machine is operated with the transport braces still in place or transported with the braces not in place, mechanical components may be damaged.
Setting up the TissueLyser	The machine must be positioned fully on the laboratory bench. Its cover must not project over the front of the bench.	Otherwise, it may be possible to reach into the machine. Danger of injury to the hands!
Electrical connection	Ensure that the values on the type plate agree with those of the available power supply.	Electronic components could otherwise be damaged
Clamping the grinding jar	Do not load the TissueLyser unequally.	In order to ensure smooth running of the TissueLyser, both milling points must be loaded with the same mass.
	Do not clamp grinding jars from the MM 2/200 or without complete steel jacket.	If clamped in the grinding jar holder of the TissueLyser, the metallic parts can cause damage to the ceramic parts.
Setting the frequency (vibration intensity)	If overloaded by a too high frequency setting, the display will alternate between the max. reached and the frequency set by you. Reduce the frequency setting to the max. value reached.	The TissueLyser does not run at the set frequency.
Grinding process	Do not open the Plexiglas cover during the grinding process.	The analysis sets or grinding jars are brought to a standstill immediately by the built-in brake, but the grinding process cannot be continued for the remaining time. The TissueLyser has to be restarted. The initial parameters are then once again available
	Do not load the TissueLyser unequally.	In order to ensure smooth running of the TissueLyser, both milling points must be loaded with the same mass.
Cleaning	Disconnect the mains plug before every cleaning operation.	Danger of fatality from electric shock!
	Do not clean the under running water	Danger of fatality from electric shock!

Warranty Conditions

1. If legitimate claims are made we shall remedy the defect or replace the goods free of charge.

The purchaser shall only have a right to rescind the contract or reduce the purchase price if we have decided that it is not possible to remedy the defect and a replacement delivery cannot be made or the time limit therefore cannot be complied with or if a reasonable additional time limit of six weeks granted by the customer has not been complied with due to our fault.

If the remedy or replacement delivery in fact fails the customer shall have the right to reduce the price or rescind the contract at his discretion. Further claims, in particular for damages in relation to damage not caused to the goods themselves, such as lost production, are excluded in so far as we have not acted willfully or negligently. For goods produced by third parties we pass on the liability of the manufacturer.

2. We shall bear the costs directly incurred through the remedying of defects or the replacement delivery on the condition that claim is found to be legitimate. This also applies to the freight costs as well as the reasonable costs of removal and installation. The customer, however, undertakes to bear the reasonable costs of providing his own technicians and assistants on site.

If our customer carries on business overseas, however, we shall be entitled to pay the costs, in particular costs of transport, tolls, wages and materials, ex German border.

3. The warranty term for newly manufactured goods is two years, for used it is one year.

The guarantee refers to deployment in a laboratory in 1-shift operation. In case of multi-shift operation or other areas of application, the guarantee term is shortened accordingly.

No warranty is given for parts subject to wear and tear.

4. We warrant that our goods are free from manufacturing defects. The suitability, classification and function of our goods are determined exclusively on the basis of the performance descriptions contained in the order confirmation even if these differ from the order. In the latter event the customer may, within two weeks after receipt of the order confirmation, draw any possible difference from the order to our attention and come to an agreement on these with us. If the customer does not object to the specifications in the order confirmation then these shall be deemed to have been accepted.

Unless an agreement to the contrary has been reached, we shall not be held liable for the suitability of the goods delivered for the use to which the customer intends to put them. The same applies to performance figures expected by the customer unless we have been able to carry out appropriate preliminary practical experiments and have, in our order confirmation, declared in writing that these performance figures shall be binding.

5. Our warranty shall also become invalid if persons other than those employed by us carry out repairs or in any other way interfere with or make alterations to the goods delivered by us or do not use suitable parts to the extent that the defect is causally connected thereto. In addition, it is a condition of our warranty that our directions for use and operation be followed.

6. If, without a release having first been obtained from us, the goods are installed in and /or connected to, attached to or incorporated in other systems or production plants then our guarantee is limited exclusively to the parts delivered by us.

7. The remedying of defects or replacement of defective parts shall, at our discretion, be carried out on site or at the seat of our company. If the repair is carried out on site, the customer shall ensure that our employee has access, unlimited in either time or space, to the purchased item. In addition, the customer may only demand that work necessary in order to fulfil warranty obligations be carried out during the normal local business hours. If such work is carried out outside our normal business hours on request, the customer shall bear the additional costs. If he wishes to have other particular work performed which goes beyond the work warranted then these costs shall be payable at the actual valid price.