



HYDROLAB[®]
WATER PURIFICATION SYSTEMS



Water source in your laboratory



www.hydrolab.eu



ABOUT US

Hydrolab is a company that designs, produces and provides service of water purification systems for laboratory purposes.

Hydrolab is a leader on the Polish market in water purification systems production. For over 20 years Hydrolab has been introducing and implementing the newest technologies of water purification by mechanical filtration, adsorption, iron removal, softening, membrane technologies (reverse osmosis, microfiltration, nanofiltration, ultrafiltration), as well as usage of 185nm and 254nm UV radiation and deionization.

In our offer we have more than a hundred models of water purification systems. On the basis of our experience and research, we designed and developed three series of demineralizers: TECHNICAL, HLP and SPRING, which are an ideal solution suiting all of the requirements of a modern laboratory in areas of ultrapure water supply. We also made a variety of unique and innovative solutions, that extend our standard offer. These are: BASIC, ULTRA, R, TECHNICAL PLUS and industrial systems: SPRING, TECHNICAL. Demineralizers may be used in analytical laboratories, as well as in dental operating rooms, beauty salons, and such industries as: electronic, food, chemical, pharmaceutical etc.

Hydrolab offers complex services of supplying laboratories with the highest quality water, giving advices in matters of a demineralized water supply - providing support from planning to installation (with a full IQ, OQ, PQ documentation).

The company has implemented the ISO 9001:2015 quality management certificate in areas of design, production and service of water purification systems, which guarantees a high quality of our products and services.

WATER

Clean water is the most important chemical reagent in a laboratory. Hydrolab offers systems producing water fitting the parameters of every water purity class, specified in PN-EN ISO 3696:1999, ASTM, CLSI, FP standards.

The quality of water in a modern laboratory, depending on its usage, should remain unchanged and proper, and its parameters (for example conductivity and temperature) should be constantly monitored. Basic standard of water quality in force in Poland are PN-EN ISO 3696:1999 for analytical laboratories, and Farmakopea Polska IX for pharmaceutical. The PN-EN ISO 3696:1999 standard describes three classes of water purity:

Class 1

Water without diluted contamination (colloidal ionic or organic), meeting the most strict analytical requirements, including a high-performance liquid chromatography. It is advised to obtain it from second purity class water, treating it with further processes (filtering through 0,2 µm membrane for substance removal, or double distillation in a quartz apparatus).

Class 2

Water with very low non-organic, organic and colloidal contamination. Should be obtained by a deionization or deionization forwarded by a reverse osmosis.

Class 3

Water for general purposes, used for „wet“ chemical tasks. Obtained by a single distillation, a deionization or a reverse osmosis.



WATER PURIFICATION TECHNOLOGY

254nm UV lamp

Disinfection of water by means of irradiation with electromagnetic waves of 254nm length, which destroy the DNA structure of microorganisms.

185/254 nm UV lamp - element combining the processes occurring in the 185-nm photo-oxidation module and UV 254 nm sterilizer.

Ultrafiltration module

The reduction of endotoxins, RNaz and Dnaz.

Microfiltration capsule 0,2/0,45µm – retention of 0,2µm particles, it constitutes the microbiological protection of the system.

Mechanical filtration

Mechanical and carbon filtration (module A) – preparing tap water for the process of reverse osmosis; it is essential because of the sensitivity of osmotic membranes to mechanical contamination and chlorine.

Softening

Softening filtration – prepares tap water for the process of reverse osmosis, removes calcium and magnesium ions from water.

Iron removal

Iron removal filtration – preparing water for the process of reverse osmosis, removes iron ions from water.

Reverse osmosis module - RO

reverse osmosis (*module RO*) – removes up to 96-99% of substances dissolved in the water supplying the system, this process determines the hydraulic efficiency of the whole system.

Demineralization on an ionex resin

Demineralization on an ionex, mixed resin (*modules H6, H7, H6TOC, H7TOC*) – the mineral salts remaining in the osmotic water are detected; after this process the conductivity of purified water reaches 0,055-0,1 µs/cm.



Technical 5/C



TECHNICAL SERIES

The TECHNICAL demineralizers are widely used water purification systems powered by tap water, and retain 96-99% of dissolved organic and non-organic contamination. Fully automated and maintenance-free, equipped with a control and measurement system, monitoring all the stages of the water purification process. Obtained water matches the PN-EN ISO 3696:1999, ASTM, CLSI standards for the third* class water quality.

Perfect for dishwashers, analyzers, autoclaves, environmental chambers, water baths, HLP demineralizers, as well as, through developing a proper network, supplying several laboratory rooms and floors in an entire building.

** depends on the quality of tap water.*

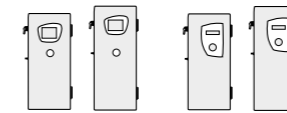

Technical 5



Technical 10

(type A automatic)

Models	Efficiency l/h	Dimensions mm	5µm	Module A2	Catalogue no
Technical 5	5	235x440x510	+	+	DT-0005-0A
Technical 10	10	235x470x570	+	+	DT-0010-0A
Technical 20	20	235x470x570	+	+	DT-0020-0A
Technical 30	30	235x470x570	+	+	DT-0030-0A
			EO-005-10	EO-MA-12	

(type C automatic)

Models	Efficiency l/h	Dimensions mm	5µm	Module A2	GAC 10"	Catalogue no
Technical 5/C	5	235x440x510	+	+	-	DT-0005-0C
Technical 10/C	10	235x470x570	+	+	-	DT-0010-0C
Technical 20/C	20	235x470x570	+	+	-	DT-0020-0C
Technical 30/C	30	235x470x570	+	+	-	DT-0030-0C
Technical 40	40	270x470x570	+	-	+	DT-0040-0C
Technical 60	60	270x470x570	+	-	+	DT-0060-0C
			EO-005-10	EO-MA-12	EW-001-10	

General information

- Powered fed by: tap water.
- Efficiency: 5-60 l/h.
- Water intake speed: 1-2 l/min.
- Retention level > 96-99%.
- Bacteria < 1cfu/ml *

Norm

Purity class of the demineralized water fits the PN-EN ISO 3696:1999 standard for a third class of water purity.

Usage

The obtained water may be used for mediums, buffer solutions, reagents. It can serve as a water supply for other laboratory devices: washers, analyzers, autoclaves, polishing systems etc.

*Device equipped with a UV lamp

** depends on the quality of tap water, retention level is 96-99%

Technical parameters:

- Works under tap water pressure.
- Water purification levels:
 - sediment filtration module 5µm,
 - module A2 (sediment-carbon-softening),
 - UV lamp (optional),
 - reverse osmosis.
- System efficiency: app. 5-60 dm³/h.
- Equipped with a pump (increasing the feed water pressure) with automatics.
- Retention level: 96-99%.
- Maximum filtrate pressure - 3 bar.
- Maintenance-free and automated.
- Equipped with a nozzle with a minimum range of 2 meters.
- Optional tank installation.
- Automatic system shutdown when the tank is full or the filtrate valve is closed.
- Optional connection to a dishwasher, an autoclave, a washer, a climatic chamber etc.
- May be used for making a demi water network with several water intake points.
- Maintenance procedures may be performed by the user (easy disposables replacement).
- Energy consumption: 40 - 100 W.
- Optional installation of a UV sterilizer.
- Can be installed by the user.
- Power supply: 230V/50Hz.

Functions protecting the device:

Pump shutdown when:

- the feed water pressure is too low (lack of feed water)
 - low pressure sensor,
 - the tank is full - high pressure sensor,
- Thermal protection of the RO module, automated system shutdown when the feed water temperature is below 4°C or above 40°C (automatic C).
- Can be automatically shut down when any alarm occurs (automatic C).
 - System autostart. (automatic C).

Functions monitoring system performance

(type A automatic):

- 24 V automatics with a microprocessor control and measurement system:
 - LCD display,
 - Conductometer measuring conductivity and temperature of demineralized water in units µS/cm or MOhm,
 - temperature compensation,
 - clock displaying date and time,
 - system status information,
- Graphic and sound alarms:
 - when need to change an A2 module (mechanical-carbon-softening),
 - when need to change a UV lamp (in models containing a UV lamp),
 - alarm informing to replace RO module,
 - service dates view,
 - service phone number customization,
 - RS 232 connector for modification of service, frequencies and alarm levels.
- Software.
- Built-in feed water manometer.

Functions monitoring the device

(type C automatic):

- The device has an automatics with a microprocessor control and measure system that includes:
- color Touch Panel display screen,
 - conductometer measuring conductivity and temperature of feed water and treated by reverse osmosis in units: µS/cm lub MOhm,
 - displaying values compensated and uncompensated thermally,
 - clock displaying date and time,
 - current system status info,
 - membrane module retention level info,
 - tank fill level,
 - water dosing (option),
 - alarm informing about necessity to change the A2 module (mechanical-carbon-softening),
 - alarm informing about necessity to change the RO module,
 - graphic and sound alarms,
 - service dates info.
- Built-in RS 232/USB connector for customizing service frequencies and alarm levels.
 - Software.
 - Built-in feed water manometer.

Feed water parameters:

- Conductivity < 1200 µS/cm
- Pressure > 3,0 bar
- Temperature: 4-40°C
- Hardness < 250 mg CaCO₃/dm³
- Fe < 0,2 mg/dm³

Required connections:

- Cold tap water connection ½" or ¾".
- 230V socket.
- Drain.

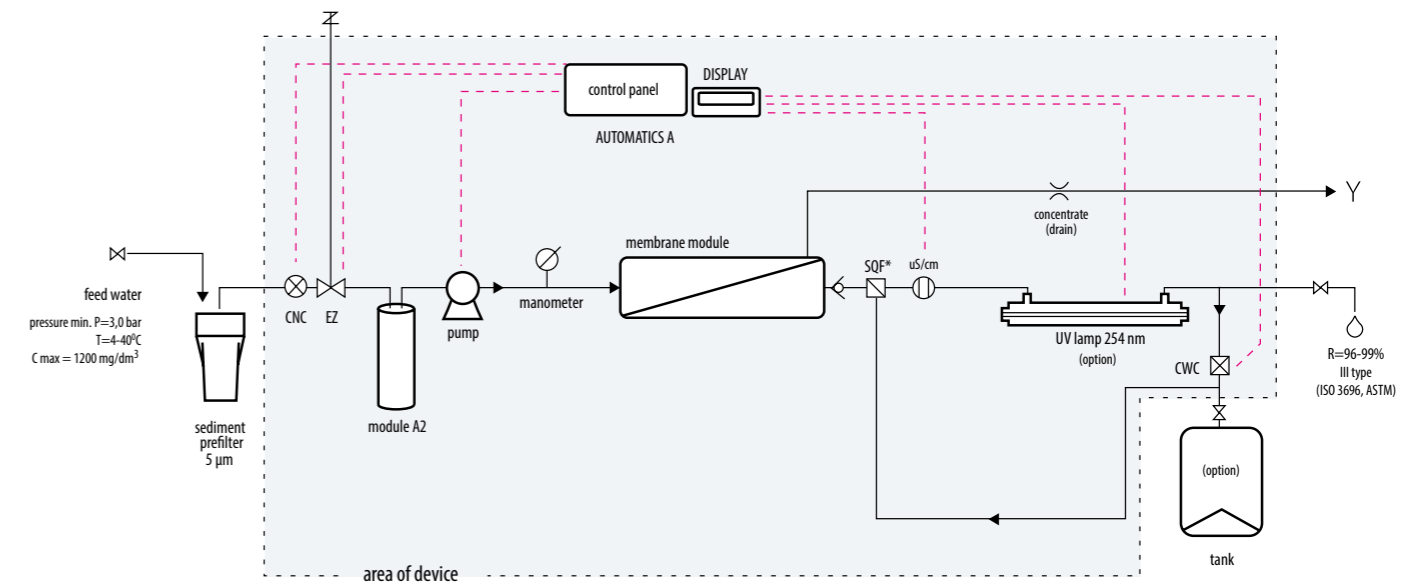

TECHNICAL
MODEL WITH AUTOMATIC A

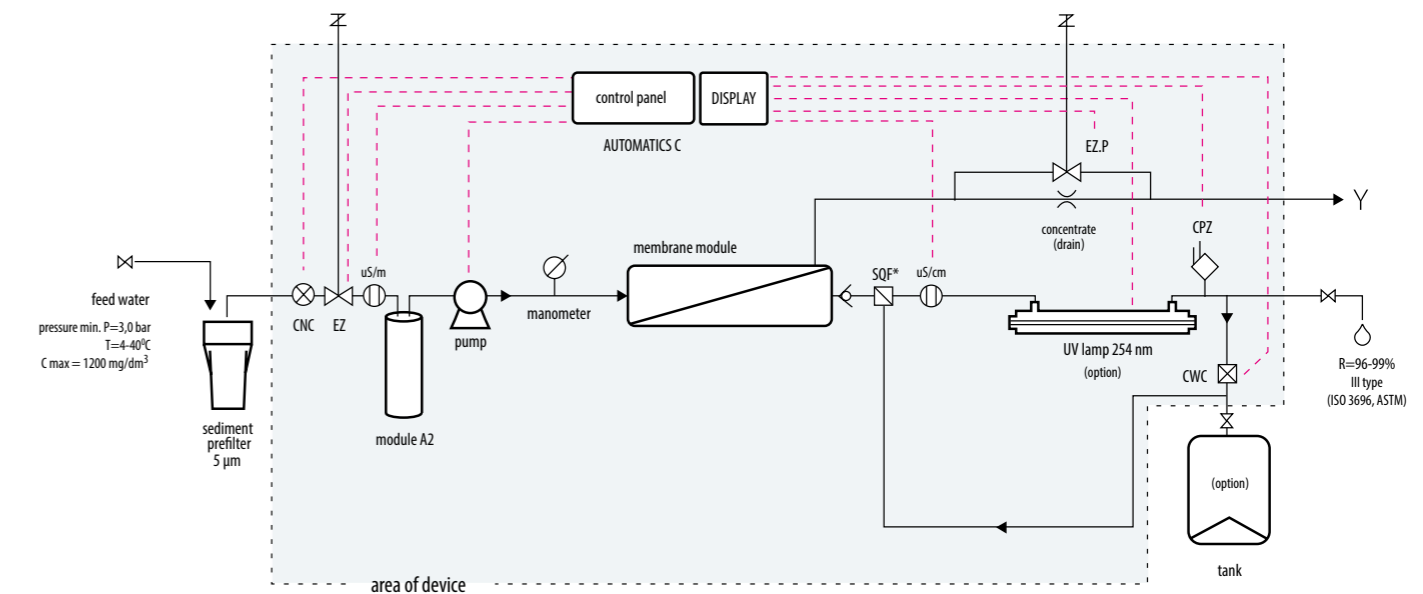

TECHNICAL
MODEL WITH AUTOMATIC C



TECHNICAL PLUS SERIES



Technical 5 PLUS



The TECHNICAL PLUS demineralizers are widely used water purification systems powered by tap water. Fully automated and maintenance-free, equipped with a control and measurement system, monitoring all the stages of the water purification process. Obtained water matches the PN-EN ISO 3696:1999, ASTM, CLSI standards for II and III class water quality.

By using the newest technology Technical Plus allows its users to decide about the quality of the water within 0,06µS/cm and 15-20 µS/cm. This process guarantees the optimization of operating costs.

Obtained water is used for preparation of mediums, reagents, buffer solutions; can be used as a source for other laboratory devices – washers, analyzers, autoclaves, environmental chambers, cleaning systems and chemical analysis.

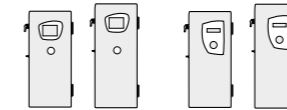

Models	Efficiency l/h	Dimensions [mm]	Prefilter 5 µm	Module A2	H6	H7, H7	UV lamp 254 nm	Catalogue no.
Technical 5 Plus	5	235x440x510	+	+	-	+	option	DT-0005-DJA
Technical 10 Plus	10	235x470x570	+	+	+	-	option	DT-0010-DJA
Technical 20 Plus	20	235x470x570	+	+	+	-	option	DT-0020-DJA
Technical 30 Plus	30	235x470x570	+	+	+	-	option	DT-0030-DJA

EO-005-10 EO-MA-12 EJ-5000-0 EJ-2000-0 EUV-254-HLP

Models	Efficiency l/h	Dimensions [mm]	Prefilter 5 µm	Module A2	H6	H7, H7	UV lamp 254 nm	Catalogue no.
Technical 5/C Plus	5	235x440x510	+	+	-	+	option	DT-0005-DJC
Technical 10/C Plus	10	235x470x570	+	+	+	-	option	DT-0010-DJC
Technical 20/C Plus	20	235x470x570	+	+	+	-	option	DT-0020-DJC
Technical 30/C Plus	30	235x470x570	+	+	+	-	option	DT-0030-DJC

EO-005-10 EO-MA-12 EJ-5000-0 EJ-2000-0 EUV-254-HLP



General information

- Powered by: tap water.
- Efficiency: 5-60 l/h.
- Water intake speed: 1-2 l/min.
- Conductivity: 0,06-15-20 $\mu\text{S}/\text{cm}$.
- Retention level > 96-99%.
- Bacteria < 1cfu/ml*.

Norm

Purity class of demineralized water fits the PN-EN ISO 3696:1999 standard for a II and III class of water purity.

Usage

may be used for mediums, buffer solutions, reagents. Can supply other laboratory devices: washers, analyzers, autoclaves, polishing systems and chemical analysis.

*Device equipped with a UV lamp

Technical parameters:

- Works under tap water pressure.
- Water purification levels:
 - sediment filtration module 5 μm ,
 - module A2 (sediment-carbon-softening),
 - UV lamp (optional),
 - reverse osmosis,
 - ion exchange cartridge
- System efficiency: app. 5-60 dm^3/h .
- Equipped with a pump (increasing the feed water pressure) with automatics.
- Water conductivity can be regulated within 0,06 $\mu\text{S}/\text{cm}$ and 15-20 $\mu\text{S}/\text{cm}$.
- Retention level: 96-99%
- Maximum filtrate pressure - 3 bar.
- Maintenance-free and automated.
- Equipped with a nozzle with a minimum range of 2 meters.
- Optional tank installation.
- Automatic system shutdown when the tank is full or the filtrate valve is closed.
- Optional connection to a dishwasher, an autoclave, a washer, a climatic chamber etc.
- May be used for making a demi water network with several water intake points.
- Maintenance procedures may be performed by the user (easy disposables replacement).
- Energy consumption: 40-100 W.
- Optional installation of a UV sterilizer.
- Can be installed by the user.
- Power supply: 230V/50Hz.

Functions protecting the device:

- Pump shutdown when:
 - the feed water pressure is too low (lack of feed water)
 - low pressure sensor,
 - the tank is full - high pressure sensor,

Functions monitoring the device (automatic A):

- The device is equipped with a microprocessor control and measurement system that includes:
 - LCD display screen 2x16 characters conductometer measuring conductivity and temperature of purified water (measured in $\mu\text{S}/\text{cm}$ or MOhm),
 - reading values compensated and uncompensated thermally,
 - timer displaying current date and time,
 - information about the membrane module retention level,
 - alarm informing about necessity to replace sediment filter and module A,
 - alarm informing about the necessity to replace the ion-exchange cartridge,
 - alarm informing about necessity to replace UV lamp (option),
 - maintenance deadlines preview,
 - built-in RS 232 connector for personal computers,
 - individual adjustment of maintenance frequency and alarm levels.
- Software.
- Built-in manometer measuring feed water pressure.

Functions monitoring the device (automatic C):

- The device is equipped with a 24V automatics with a microprocessor control and measurement system, that includes:
- color display screen with a Touch Panel.
 - conductometer measuring conductivity and temperature of feed and purified water (measured in $\mu\text{S}/\text{cm}$ or MOhm),
 - clock displaying date and time,
 - information about current system status,
 - information about the membrane module retention level,
 - alarm informing about necessity to replace the mechanical and/or activated carbon filter,
 - graphic and sound alarm signal,
 - alarm informing about the necessity to replace the UV lamp heater,
 - maintenance preview,
 - built-in RS 232 connection to personal computers allowing to adjust maintenance frequency and alarm levels,
 - built-in USB connection to personal computers allowing to adjust maintenance frequency and alarm levels.
- Software.
 - Built-in manometer measuring feed water pressure.

Feed water parameters:

- Conductivity < 1200 $\mu\text{S}/\text{cm}$.
- Pressure > 3,0 bar,
- Temperature: 4-40 $^{\circ}\text{C}$.
- Hardness < 250 $\text{mg CaCO}_3/\text{dm}^3$
- Fe < 0,2 mg/dm^3 .

Required connections:

- Cold tap water connection 1/2" or 3/4"
- 230V socket.
- Drain.

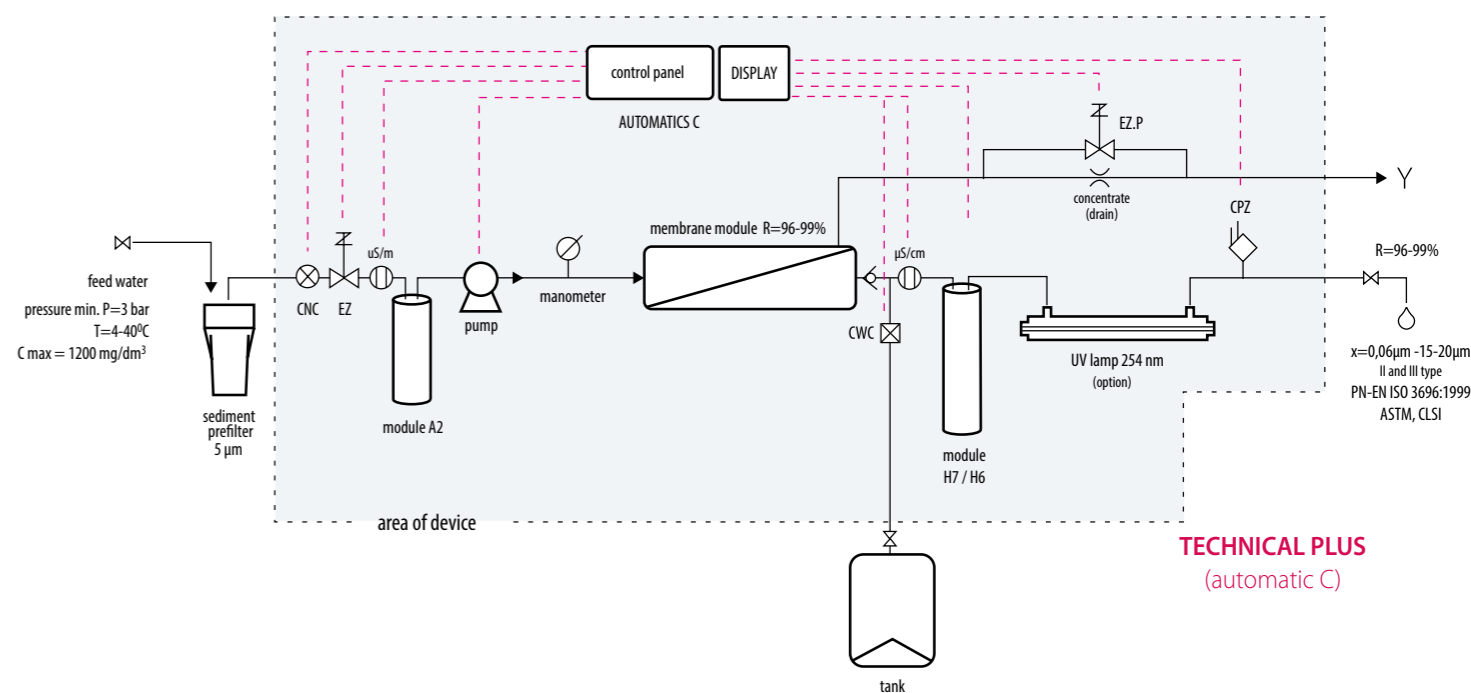
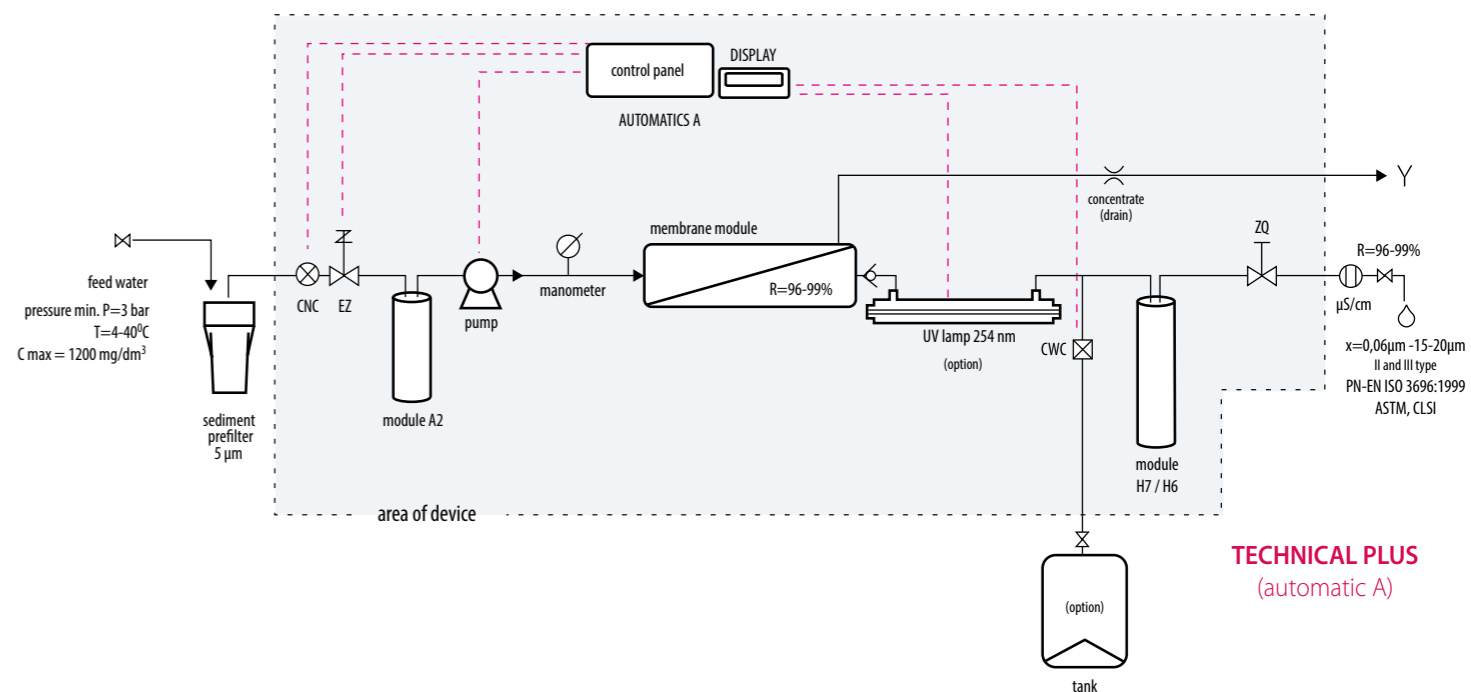



HLP SMART



HLP 10



HLP 5



HPLC SERIES

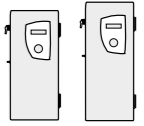

HPL demineralizers are powered by tap water and match requirements of an every modern laboratory, in areas of supplying with purified water for instrumental and analytical purposes. Conductivity of obtained water does not exceed 0,06 $\mu\text{S}/\text{cm}$, so it is applicable for PN-EN ISO 3696:1999, ASTM, CLSI, FP standards. Water may also be used for AAS, ICP/MS, IC, HPLC, GC instrumental analyses depends of model. In addition, our demineralizers are equipped with a microprocessor control and measurement system.

Models 5 l/h	Dimensions [mm]	Prefilter 5 μm	Module A2	Microfiltration 0,2 μm	Pump 24V	Pump 48V	UV Lamp	Module H7	Module H7 TOC	Module H6	Module H6 TOC	Standard PN-EN 3696:1999	Catalogue no.
SMART	200x375x430	+	+	-	-	-	-	+	-	-	-	II class	DH-0004-00

Models 5 l/h	Dimensions [mm]	Prefilter 5 μm	Module A2	Microfiltration 0,2 μm	Pump 24V	Pump 48V	UV Lamp	Module H7	Module H7 TOC	Module H6	Module H6 TOC	Standard PN-EN 3696:1999	Catalogue no.
HLP 5	235x440x510	+	+	-	-	-	-	+	-	-	-	II class	DH-0005-00
HLP 5s	235x440x510	+	+	+	-	-	-	+	-	-	-	I class	DH-0005-0S
HLP 5p	235x440x510	+	+	-	+	-	-	+	-	-	-	II class	DH-0005-0P
HLP 5sp	235x440x510	+	+	+	+	-	-	+	-	-	-	I class	DH-0005-SP
HLP 5uv	235x440x510	+	+	+	+	-	+	-	+	-	-	I class	DH-0005-UV

Models 10 l/h	Dimensions [mm]	Prefilter 5 μm	Module A2	Microfiltration 0,2 μm	Pump 24V	Pump 48V	UV Lamp	Module H7	Module H7 TOC	Module H6	Module H6 TOC	Standard PN-EN 3696:1999	Catalogue no.
HLP 10	235x470x570	+	+	-	-	-	-	-	-	+	-	II class	DH-0010-00
HLP 10s	235x470x570	+	+	+	-	-	-	-	-	+	-	I class	DH-0010-0S
HLP 10p	235x470x570	+	+	-	+	-	-	-	-	+	-	II class	DH-0010-0P
HLP 10sp	235x470x570	+	+	+	+	-	-	-	-	+	-	I class	DH-0010-SP
HLP 10uv	235x470x570	+	+	+	+	-	+	-	-	-	+	I class	DH-0010-UV

Models 20 l/h	Dimensions [mm]	Prefilter 5 μm	Module A2	Microfiltration 0,2 μm	Pump 24V	Pump 48V	UV Lamp	Module H7	Module H7 TOC	Module H6	Module H6 TOC	Standard PN-EN 3696:1999	Catalogue no.
HLP 20	235x470x570	+	+	-	-	+	-	-	-	+	-	II class	DH-0020-00
HLP 20s	235x470x570	+	+	+	-	+	-	-	-	+	-	I class	DH-0020-0S
HLP 20p	235x470x570	+	+	-	-	+	-	-	-	+	-	II class	DH-0020-0P
HLP 20sp	235x470x570	+	+	+	-	+	-	-	-	+	-	I class	DH-0020-SP
HLP 20uv	235x470x570	+	+	+	-	+	+	-	-	-	+	I class	DH-0020-UV

Models 30 l/h	Dimensions [mm]	Prefilter 5 μm	Module A2	Microfiltration 0,2 μm	Pump 24V	PPump 48V	UV Lamp	Module H7	Module H7 TOC	Module H6	Module H6 TOC	Standard PN-EN 3696:1999	Catalogue no.
HLP 30	235x470x570	+	+	-	-	+	-	-	-	+	-	II class	DH-0030-00
HLP 30s	235x470x570	+	+	+	-	+	-	-	-	+	-	I class	DH-0030-0S
HLP 30p	235x470x570	+	+	-	-	+	-	-	-	+	-	II class	DH-0030-0P
HLP 30sp	235x470x570	+	+	+	-	+	-	-	-	+	-	I class	DH-0030-SP
HLP 30uv	235x470x570	+	+	+	-	+	+	-	-	-	+	I class	DH-0030-UV

Catalogue no.	EO-005-10	EO-MA-12	EM-SP-20	A-P-024	A-P-048	EUV-254-HLP	EJ-2000-0	EJ-2000-1	EJ-5000-0	EJ-5000-1		
---------------	-----------	----------	----------	---------	---------	-------------	-----------	-----------	-----------	-----------	--	--

General information

- Powered by: tap water.
- Efficiency: 4-30 dm³/h.
- Purified water intake speed: 1-2 l/min.
- Conductivity < 0,06 µS/cm.
- Bacteria < 1cfu/ml*.
- Particles > 0,2µm < 1/ml*.

Standard:

Water purified in this device fits the PN-EN ISO 3696:1999 standard for I*, II, III purity class, and microbiological/ physicochemical FP requirements for purified production water*.

Application:

Obtained water may be used for instrumental analyses AAS, ICP/MS, IC, HPLC*, GC*, bacteria cultures*, biochemical analyses*.

* device equipped with a UV lamp and/or a microfiltration capsule 0,22 µm

Technical parameters:

- Device operates under tap water pressure.
- Water purification levels:
 - sediment filtration 5µm,
 - module A2 filtration (mechanical-carbon-softening),
 - reverse osmosis,
 - ion exchange demineralization,
 - UV lamp – 254 nm (model: HLPUV),
 - microfiltration cascade capsule 0,45/0,22 µm (models: HLPs, HLPsp, HLPUV),
- Automatic and maintenance-free.
- Equipped with a pump increasing the pressure of 24V power, with automatics (selected models).
- The water intake point (purity class: PN-EN ISO 3696:1999) equipped with a demi faucet with a minimum reach of 2mb
- Movable, regulated INOX frame strenghtening water intake points, allows to regulate the settings up/down, right/left, front/back.
- Can be connected to a dishwasher, an autoclave, analyzer etc.
- Optional UV sterilizer.
- Power supply 230V/50Hz.
- Energy consumption: 10-100W.
- Can be installed by the user.

Functions monitoring system performance:

- 24 V automatics with a microprocessor control and measurement system:
 - LCD display,
 - conductometer measuring conductivity and temperature of demineralized water in units µS/cm or MOhm,
 - temperature compensation,
 - clock displaying date and time,
 - system status information,
- Graphic and sound alarms:
 - when need to change an A2 module (mechanical-carbon-softening),
 - when need to change an UV lamp (in models containing a UV lamp),
 - alarm informing to replace microfiltration capsule (models with microfiltration capsule),
 - alarm informing to replace ion exchange cartridge
 - service dates view,
 - service phone number customization,
 - RS 232 connector for modification of service, frequencies and alarm levels.

• Software.

• Built-in feed water manometer.

Functions protecting the device:

- Pump shutdown when:
 - feed water pressure is too low (lack of feed water) – low pressure sensor,
 - the tank is full – high pressure sensor.

Feed water parameters:

- Conductivity < 1200 µS/cm.
- Pressure > 3,0 bar.
- Temperature : 4-40°C.
- Hardness < 250 mg CaCO₃/dm³
- Fe < 0,2 mg/dm³

Installation point connections:

- Cold tap water connection ½" or ¾".
- 230V power supply socket.
- Drain.

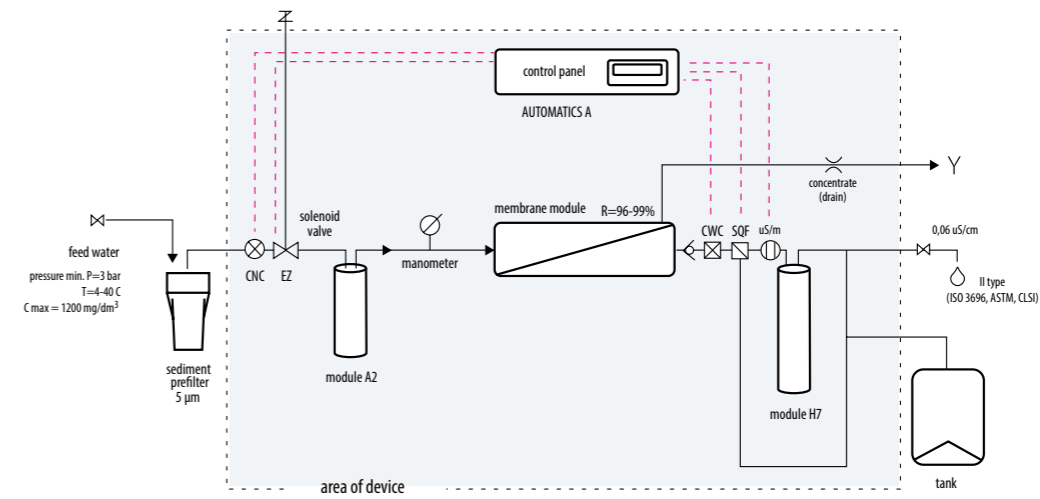

HLP 5

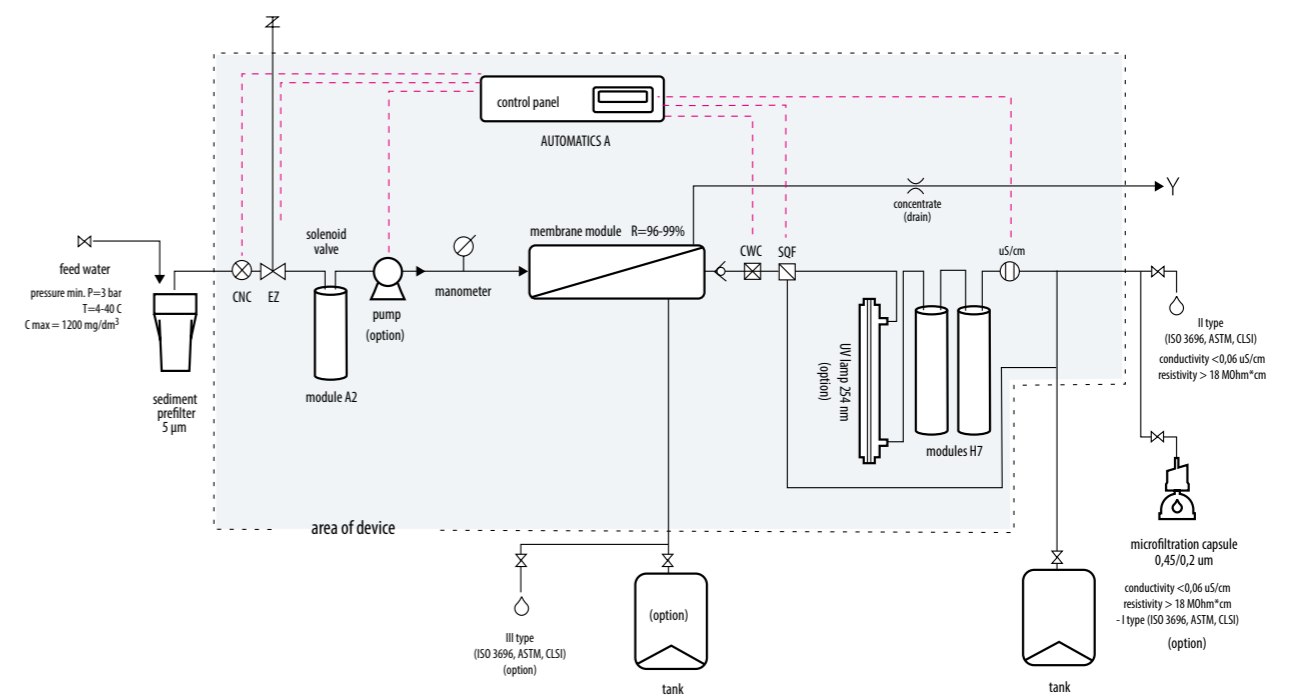

HLP 10
HLP 20
HLP 30

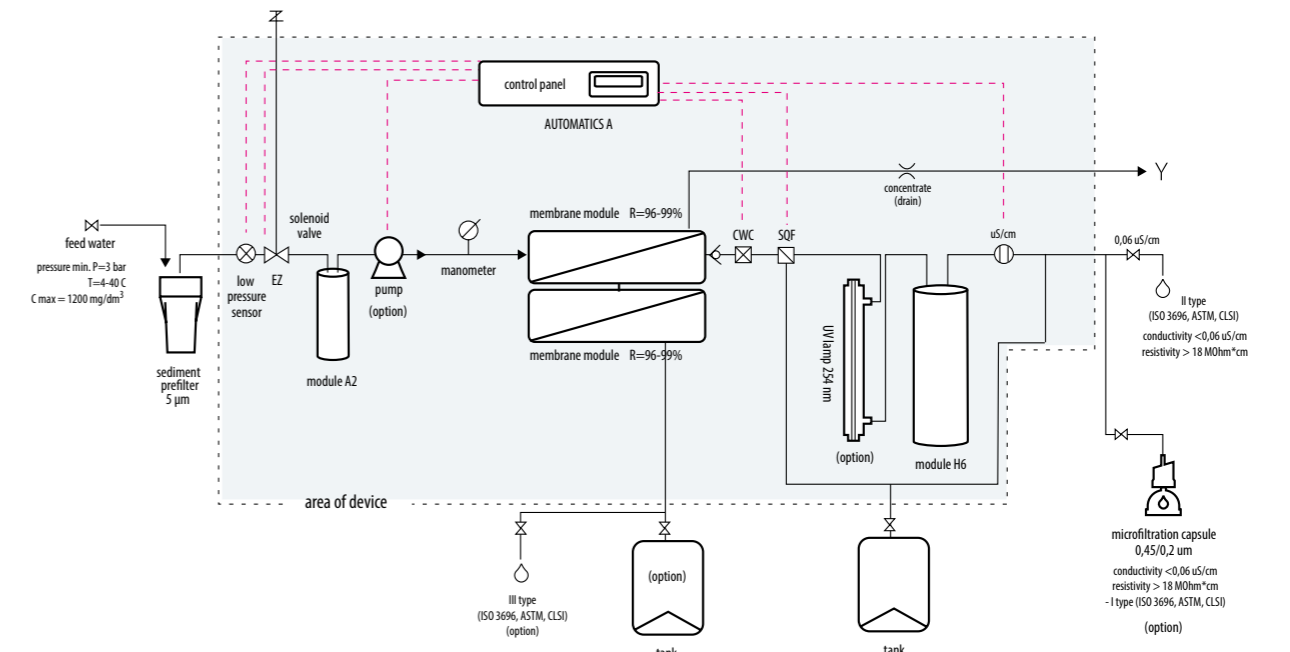



SPRING SERIES

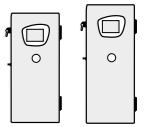

SPRING 5 UV



SPRING 5

SPRING demineralizers are devices powered by tap water, with extended equipment and advanced automatics. Similar to HLP series, SPRING systems produce water of 0,055 $\mu\text{S}/\text{cm}$ conductivity, matching the requirements of standards: PN-EN ISO 3696:1999, ASTM, CLSI, FP. These devices are intended for more demanding users, equipped with advanced automatics, that monitors the disposables usage, archiving data, allowing personalization of alarm levels for feed water, after reverse osmosis treatment and ultrapure, membrane rinsing and work with several adju-tages simultaneously.

Depending on a model, the water obtained may be used for AAS, ICP/MS, IC, HPLC and GC instrumental analyses. Spring demineralizers are equipped with a microprocessor control and measurement system, which ensure that the demineralization process is running correctly (auto-mation C).

Models 5 l/h	Dimensions [mm]	Prefilter 5 μm	Module A2	Microfiltration 0,2 μm	Pump 24V	Pump 48V	UV Lamp	Module 2xH7	Module 2xH7TOC	Module GAC10"	Module H6	Module H6TOC	Standard PN-EN 3696:1999	Catalogue no
SPRING 5	235x440x510	+	+	-	+	-	-	+	-	-	-	-	2 class	5DS-TOC-00
SPRING 5s	235x440x510	+	+	+	+	-	-	+	-	-	-	-	1 class	5DS-TOC-0S
SPRING 5uv	235x440x510	+	+	+	+	-	+	-	+	-	-	-	1 class	5DS-TOC-UV

Models 10 l/h	Dimensions [mm]	Prefilter 5 μm	Module A2	Microfiltration 0,2 μm	Pump 24V	Pump 48V	UV Lamp	Module 2xH7	Module 2xH7TOC	Module GAC10"	Module H6	Module H6TOC	Standard PN-EN 3696:1999	Catalogue no
SPRING 10	235x470x570	+	+	-	+	-	-	-	-	-	+	-	2 class	10DS-TOC-00
SPRING 10s	235x470x570	+	+	+	+	-	-	-	-	-	+	-	1 class	10DS-TOC-0S
SPRING 10uv	235x470x570	+	+	+	+	-	+	-	-	-	-	+	1 class	10DS-TOC-UV

Models 20 l/h	Dimensions [mm]	Prefilter 5 μm	Module A2	Microfiltration 0,2 μm	Pump 24V	Pump 48V	UV Lamp	Module 2xH7	Module 2xH7TOC	Module GAC10"	Module H6	Module H6TOC	Standard PN-EN 3696:1999	Catalogue no
SPRING 20	235x470x570	+	+	-	-	+	-	-	-	-	+	-	2 class	20DS-TOC-00
SPRING 20s	235x470x570	+	+	+	-	+	-	-	-	-	+	-	1 class	20DS-TOC-0S
SPRING 20uv	235x470x570	+	+	+	-	+	+	-	-	-	-	+	1 class	20DS-TOC-UV

Models 30 l/h	Dimensions [mm]	Prefilter 5 μm	Module A2	Microfiltration 0,2 μm	Pump 24V	Pump 48V	UV Lamp	Module 2xH7	Module 2xH7TOC	Module GAC10"	Module H6	Module H6TOC	Standard PN-EN 3696:1999	Catalogue no
SPRING 30	235x470x570	+	+	-	-	+	-	-	-	-	+	-	2 class	30DS-TOC-00
SPRING 30s	235x470x570	+	+	+	-	+	-	-	-	-	+	-	1 class	30DS-TOC-0S
SPRING 30uv	235x470x570	+	+	+	-	+	+	-	-	-	-	+	1 class	30DS-TOC-UV

Models 40 l/h	Dimensions [mm]	Prefilter 5 μm	Module A2	Microfiltration 0,2 μm	Pump 24V	Pump 48V	UV Lamp	Module 2xH7	Module 2xH7TOC	Module GAC10"	Module H6	Module H6TOC	Standard PN-EN 3696:1999	Catalogue no
SPRING 40	270x470x570	+	-	-	-	+	-	-	-	+	+	-	2 class	40DS-TOC-00
SPRING 40uv	270x470x570	+	-	+	-	+	+	-	-	+	-	+	1 class	40DS-TOC-UV

Models 60 l/h	Dimensions [mm]	Prefilter 5 μm	Module A2	Microfiltration 0,2 μm	Pump 24V	Pump 48V	UV Lamp	Module 2xH7	Module 2xH7TOC	Module GAC10"	Module H6	Module H6TOC	Standard PN-EN 3696:1999	Catalogue no
SPRING 60	270x470x570	+	-	-	-	+	-	-	-	+	+	-	2 class	60DS-TOC-00
SPRING 60uv	270x470x570	+	-	+	-	+	+	-	-	+	-	+	1 class	60DS-TOC-UV

Catalogue no EO-005-10 EO-MA-12 EM-SP-20 A-P-024 A-P-048 EUV-254-HLP EJ-2000-0 EJ-2000-1 EW-001-10 EJ-500-0 EJ-5000-1

General information:

- Powered by: tap water.
- Efficiency: 5-60 l/h.
- Purified water dosage speed 1-2 l/min.
- Conductivity < 0,055 $\mu\text{S}/\text{cm}$.
- Bacteria < 1 cfu/ml*.
- Particles > 0,2 μm < 1/ml*.

Standard:

Water purified in this device fits the PN-EN ISO 3696:1999 standard for I*, II, III purity class, and microbiological/physicochemical FP requirements for purified production water*.

Application:

Obtained water may be used for instrumental analyses AAS, ICP/MS, IC, HPLC*, GC*, bacteria cultures*, biochemical analyses*.

* device equipped with a UV lamp and/or a microfiltration capsule 0,22 μm

Technical specification:

- Device operates under tap water pressure.
- Water purification levels:
 - module 5 μm filtration,
 - module A2 filtration (sedimentary-carbon-softening),
 - module RO,
 - ion exchange demineralization (SQF system)
 - UV lamp 254 nm (SPRING-UV),
 - microfiltration capsule 0,45/0,2 μm (SPRING-S, SPRING-UV).
- Automatic and unattended system operation
- System equipped with a pump increasing feed water pressure, with an automatics.
- Water intake point – purity class according to PN-EN ISO 3696:1999 equipped with a demi water nozzle of a min. 2 m reach.
- System equipped with a 10dm³ pressure storage tank (ability to exchange for bigger one).
- Optional connection to a washer, an autoclave, an analyser etc.
- Optional installation of a UV sterilizer.
- Maximum operating pressure: 1 MPa.
- User-performed maintenance procedures (easy disposables replacement).
- Intended to be fed by cold water: 4-40°C.
- Automatic membrane module rinsing.
- Energy consumption 20-100W.
- Power supply: 230V/50Hz.
- Optional user-performed device installation.

Functions protecting the device:

- Pump shutdown when:
 - the feed water pressure is too low (lack of feed water) low pressure sensor,
 - the tank is full - high pressure sensor.
- Thermal protection of the RO module, automated system shutdown when the feed water temperature is below 4°C or above 40°C.
- Can be automatically shut down when any alarm occurs.
- System autostart.

Functions monitoring system performance: (aut. C)

The device is equipped with a microprocessor automatic, that includes:

- Color display screen with a Touch Panel function.
- Conductometer measuring water pressure: feed, after reverse osmosis and demineralized (in $\mu\text{S}/\text{cm}$ or MOhm).
- Clock displaying date and time.
- Actual system state information.
- Membrane retention level information.
- Tank fill level.
- Water dosage.
- Alarm informing about the necessity to replace the mechanical and carbon filters.
- Alarm informing about the necessity to replace the A2 module.
- Alarm informing about the necessity to replace the ion exchange module.
- Alarm informing about the necessity to replace the UV lamp radiator.
- Alarm informing about the necessity to replace the microfiltration capsule.
- Alarm informing about the necessity to replace the RO.
- Graphic and sound alarm signal.
- Service dates view.
- RS 232 connector for service frequency and alarm levels adjustment.
- USB connector for service frequency and alarm levels adjustment.
- External software to calibrate the device.
- Built-in feed water manometer.

Feed water parameters:

- Conductivity < 1200 $\mu\text{S}/\text{cm}$.
- Pressure > 3,0 bar.
- Temperature : 4-40°C.
- Hardness < 250 mg CaCO₃/dm³
- Fe < 0,2 mg/dm³

Installation point connections:

- Cold tap water connection 1/2" or 3/4".
- 230V power supply socket.
- Drain.

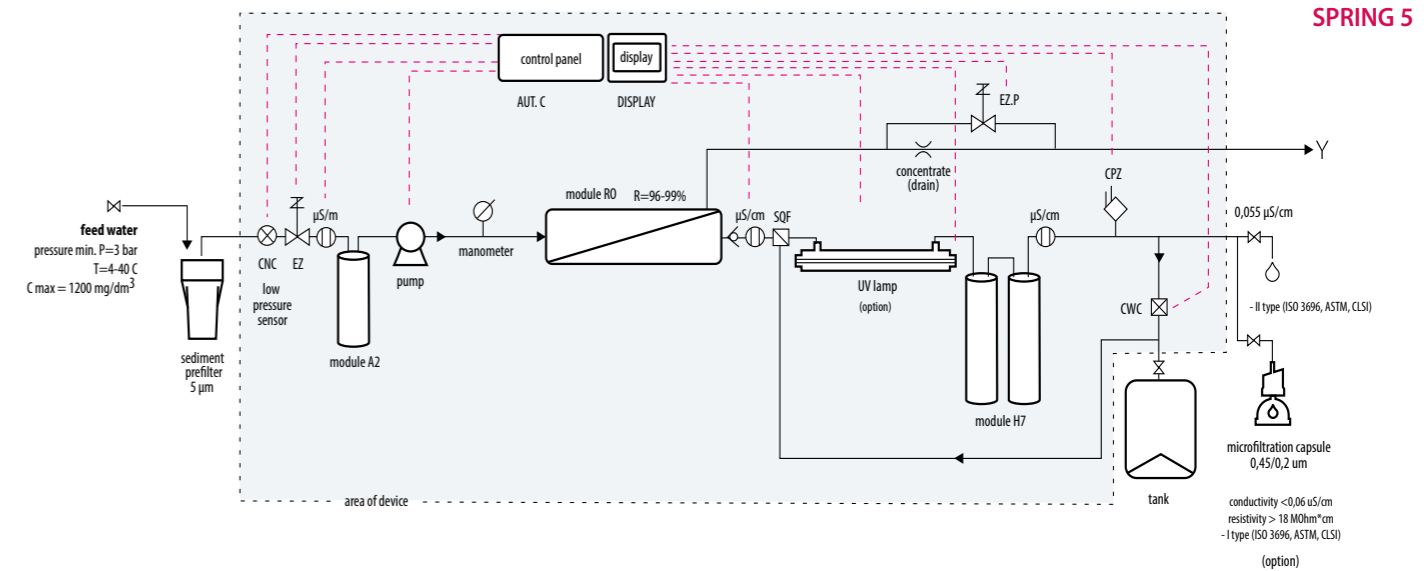

SPRING 5

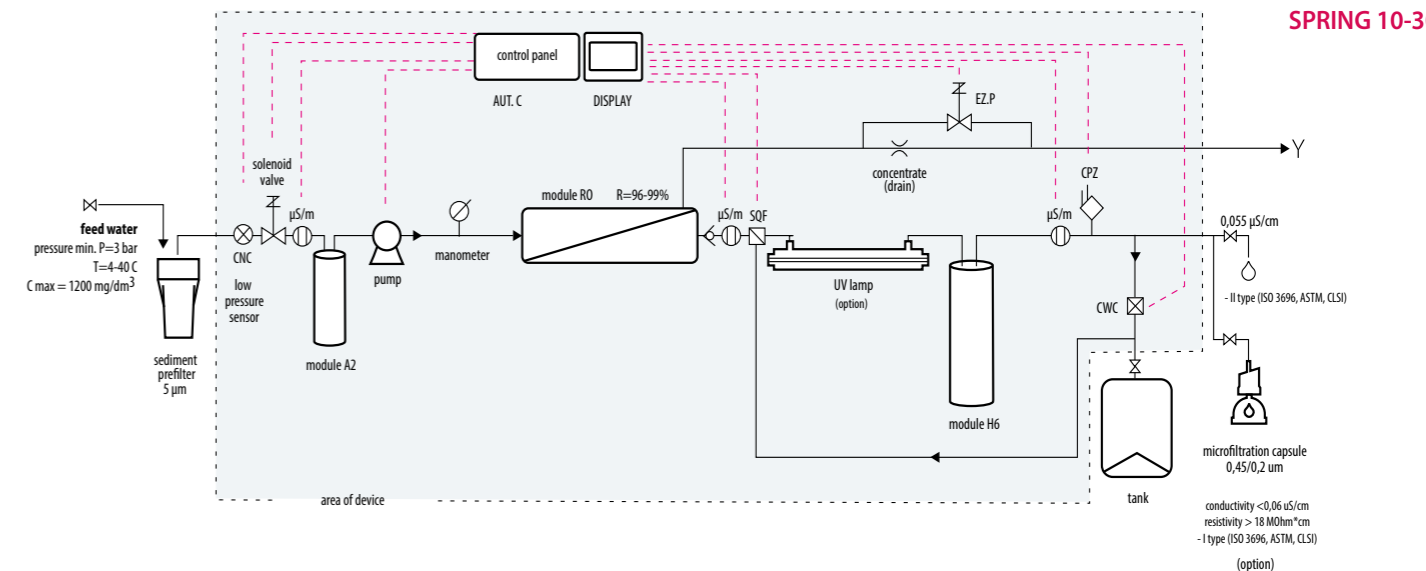

SPRING 10-30

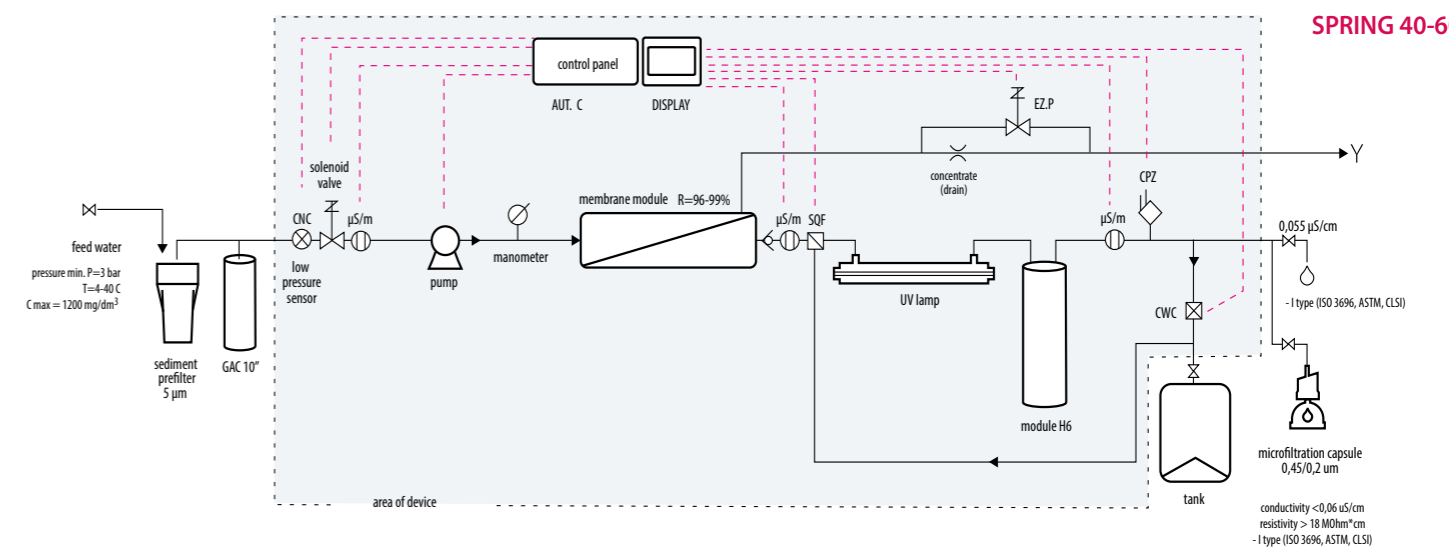

SPRING 40-60



ULTRA



ULTRA UV



ULTRA SERIES



Devices providing ultrapure water, that fits the PN-EN ISO 3696:1999 standard for first purity class.

System is fed by an external source of initially purified water that fits the requirements of II or III purity class, according to PN-EN ISO 3696:1999.

Cleaning module is a fully automated and maintenance-free system, equipped by default with an automatic diagnostic apparatus.

Water purification levels (depend on the model) demineralization and recirculation on a mixed ion exchange resin (TOC), UV lamp, ultrafiltration, microfiltration (0,45/0,22 µm capsule).

MODELS

ULTRA – device equipped with a basic ion exchange TOC module, photoxydation module 254 nm (185 nm lamp option) and a microfiltration capsule (0,45/0,2 µm) in the recirculation loop.

ULTRA UV – device equipped with a basic ion exchange TOC module, photooxidation UV module (185/254 nm) and a microfiltration capsule in the recirculation loop 0,45/0,2 µm.

ULTRA UF – device equipped with a basic ion exchange TOC module, ultrafiltration module, photooxidation UV module (185/254 nm) and a microfiltration capsule (0,45/0,2 µm) in the recirculation loop.

MODELS

Models	Microfiltration 0,2 µm	Cleaning ionite H7 TOC	UV Lamp 185/254 nm	UV Lamp 254 nm	Ultrafiltration module	Catalogue no.
Ultra	+	+	-	+	-	DR-TOC-00
Ultra UV	+	+	+	-	-	DR-TOC-UV
Ultra UF	+	+	+	-	+	DR-TOC-UF
	EM-SP-20	EJ-2000-1	EUV-185-254-HLP	EUV-254-HLP	EU-HLP-01	

dimensions: 235x470x570 mm

General information:

- Powered by: II, III purity class water.
- Purified water dosage speed 1-2 l/min.
- Conductivity < 0,055 $\mu\text{S}/\text{cm}$.
- TOC < 5 ppb.
- Bacteria < 1 cfu/ml.
- Particles > 0,2 μm < 1/ml.
- endotoxins < 0,001 EU/ml*.
- RNases < 0,01 ng/ml*.
- DNases < 4 pg/ μl *.

Standard:

Water purified in this device fits the PN-EN ISO 3696:1999 standard for I purity class, and microbiological/physicochemical FP requirements for purified production water.

Application:

Obtained water may be used for instrumental analyses AAS, ICP/MS, IC, HPLC, GC, bacteria cultures, biochemical analyses, molecular biology*.

* device equipped with an ultrafiltration module UF

Technical parameters:

- Water purification levels:
 - demineralization on a spectrally clean mixed ion exchange TOC resin,
 - UV lamp: 185/254 nm or 254 nm,
 - ultrafiltration module (ultra UF),
 - cascade microfiltration capsule 0,45/0,2 μm .
- Automatic and unattended system operation.
- Power from an external pre-treated water supply; II and III degree of cleanliness according to PN-EN ISO 3696: 1999.
- System equipped with a recirculation pump.
- Mobile intake point of water – first purity class according to PN-EN ISO 3696:1999, equipped with a microfiltration capsule 0,45/0,2 μm .
- Recurring, automatic purified water recirculation between water intakes.
- Ultra-pure water feed rate min. 1 dm^3/min .
- Automatic system shutdown if full recirculation.
- User-performed maintenance procedures (easy disposables replacement).
- Intended to be fed by cold water: 4-40°C.
- Energy consumption 100W.
- Optional user-performed device installation.
- Power supply: 230V/50Hz.

Functions monitoring the device:

The device is equipped with a 24V automatics with a micro-processor control and measurement system, that includes:

- Color display screen with a Touch Panel.
- Conductometer measuring conductivity and temperature of purified water (measured in $\mu\text{S}/\text{cm}$ or $\text{M}\Omega\text{m}$).
- Reading values compensated and uncompensated thermally.
- Clock displaying date and time.
- Information about current system status.
- Alarm informing about the necessity to replace the ionex resins.
- Alarm informing about the necessity to replace the UV lamp.
- Alarm informing about the necessity to replace the microfiltration capsule.
- Alarm informing about the necessity to replace the module ultrafiltration.
- Graphic and sound alarm signal.
- Maintenance dates preview.
- Built-in RS 232 connection to personal computers allowing to adjust maintenance frequency and alarm levels.
- Built-in USB connection to personal computers allowing to adjust maintenance frequency and alarm levels.
- External software to calibrate the device.
- Built-in manometer measuring feed water pressure.

Functions protecting the device:

- Can be automatically shut down when any alarm occurs.
- System autostart.
- Notification/alarm preview.

Required connections:

- Required connections:
- 230V socket.
 - 1/2", 3/4" or 6 mm cold pre-purified water connection (minimum pressure 1 bar required)

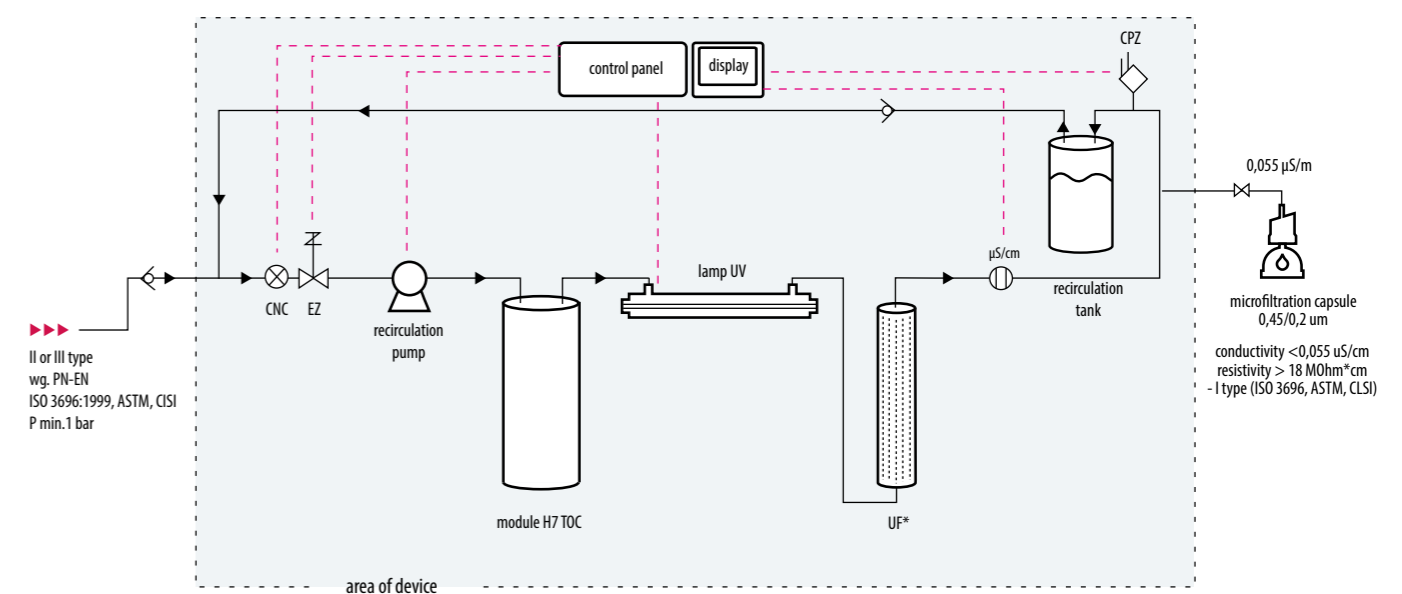

ULTRA



R 10-30



R 5



R SERIES

R demineralizers are devices that combine features of two series: Technical and Ultra into one system, optimizing investment costs by reduction of shared construction areas. These devices produce ultrapure water fitting the FP and PN-EN ISO 3696:1999 standard for first purity class. They are also equipped with an extended automatics, that allows the user to monitor disposables performance, data archiving, individual adjustment of alarm levels for feed water parameters, water after reverse osmosis and ultrapure, along with controlling the function of automatic membrane modules rinsing. These systems also have a set of protections for comfortable system operation.



MODELE

Models	Microfiltration 0,2µm	Cleaning ionite H7 TOC	Cleaning ionite H6 TOC	UV Lamp 185/254 nm	UV Lamp 254 nm	Ultrafiltration module	Catalogue no.
R5	+	+	-	-	+	-	5DR-TOC-00
R5 UV	+	+	-	+	-	-	5DR-TOC-UV
R5 UF	+	+	-	+	-	+	5DR-TOC-UF
R10	+	-	+	-	+	-	10DR-TOC-00
R10UV	+	-	+	+	-	-	10DR-TOC-UV
R10UF	+	-	+	+	-	+	10DR-TOC-UF
R20	+	-	+	-	+	-	20DR-TOC-00
R20UV	+	-	+	+	-	-	20DR-TOC-UV
R20UF	+	-	+	+	-	+	20DR-TOC-UF
R30	+	-	+	-	+	-	30DR-TOC-00
R30UV	+	-	+	+	-	-	30DR-TOC-UV
R30UF	+	-	+	+	-	+	30DR-TOC-UF

EM-SP-20

EJ-2000-1

EJ-5000-1

EUV-185-254-HLP

EUV-254-HLP

EU-HLP-01

General information:

- Powered by: tap water.
- Efficiency: 5-30 l/h.
- Purified water dosage speed 1-2 l/min.
- Conductivity < 0,055 µS/cm.
- TOC < 5 ppb.
- Bacteria < 1 cfu/ml.
- Particles > 0,2 µm < 1/ml.
- Endotoxins < 0,001 EU/ml*.
- RNases < 0,01 ng/ml*.
- DNases < 4 pg/µl*.

Standard:

Water purified in this device fits the PN-EN ISO 3696:1999 standard for I purity class and microbiological/physicochemical FP requirements for purified production water.

Application:

Obtained water may be used for instrumental analyses AAS, ICP/MS, IC, HPLC, GC, bacteria cultures, biochemical analyses, molecular biology*

* device equipped with an ultrafiltration module UF.

Technical specification:

- Device operates under tap water pressure.
- Water purification levels:
 - sediment filtration 5 µm,
 - module A,
 - reverse osmosis,
 - ion exchange demineralization (TOC),
 - UV lamp: 185/254 nm or 254 nm,
 - ultrafiltration module UF,
 - microfiltration capsule 0,45/0,2µm.
- Automatic and maintenance-free system operation.
- System equipped with a recirculation pump.
- Mobile intake point of water – first purity class according to PN-EN ISO 3696:1999 equipped with a microfiltration capsule 0,45/0,2 µm.
- Optional installation of an additional water intake point for general laboratory purposes – III purity class, according to PN-EN ISO 3696:1999.
- Built-in recirculation tank 2l with filter.
- Recurring, automatic purified water recirculation between water intakes.
- System equipped with a 10dm³ pressure storage tank (RO)
- Automatic membrane module rinsing.
- Automatic system shutdown when a tank is full
- User-performed maintenance procedures (easy disposables replacement).
- Intended to be fed by cold water: 5-40°C.
- Energy consumption: 100W.
- Optional user-performed device installation.
- Power supply: 230V/50Hz.

Functions monitoring system performance:

The device is equipped with a microprocessor control and measurement system, that includes:

- Color display screen with a Touch Panel function.
- Conductometer measuring water pressure: feed, after reverse osmosis and demineralized (in µS/cm or MOhm).
- Displaying values compensated thermally.
- Clock displaying date and time.
- Actual system state information.
- Membrane retention level information.
- Tank fill level.
- Alarm informing about necessity to replace the RO module.
- Alarm informing about necessity to replace the mechanical filter and module A.
- Alarm informing about necessity to replace the ion exchange module.
- Alarm informing about necessity to replace the UV lamp radiator.
- Alarm informing about necessity to replace the microfiltration capsule.
- Alarm informing about necessity to replace the ultrafiltration capsule.
- Graphic and sound alarm signal.
- Service dates display.
- RS 232 connector for service frequency and alarm levels adjustment.
- USB connector for service frequency and alarm levels adjustment.
- Software.
- Built-in feed water manometer.

Functions protecting system performance:

- Pump shutdown when:
 - feed water pressure is too low (no feed water) - low pressure sensor,
 - tank is full - high pressure sensor.
- RO thermal protection - automatic system shutdown if the feed water temperature is below 4°C or above 40°C.
- Can be automatically shut down when any alarm occurs.
- System autostart.
- System message/alarm view.

Feed water parameters:

- Conductivity < 1200 µS/cm
- Pressure > 3,0 bar.
- Temperature: 4-40°C.
- Hardness < 250 mg CaCO₃/dm³
- Fe < 0,2 mg/dm³.

Installation point connections:

- Cold tap water connection ½" or ¾".
- 230V power supply socket.
- Drain.

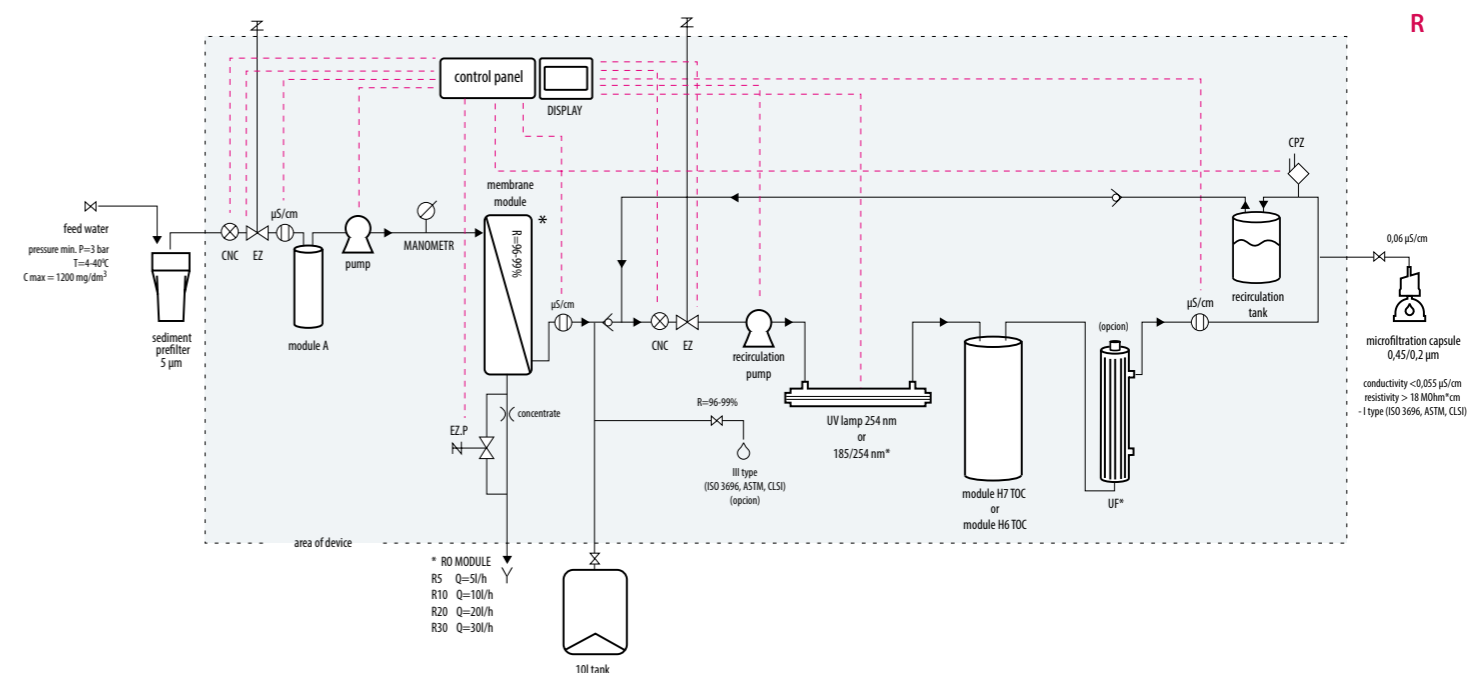



BASIC 5



BASIC 10



BASIC SERIES

BASIC deionizers are devices of a high demineralized water production efficiency. The quality of obtained water (depends on the tap water flow intensity) varies between 0,06-0,8 $\mu\text{S}/\text{cm}$.

Fully automated and maintenance-free devices are equipped with a microprocessor control and measurement system, which constantly monitors the water parameters. Purified water fits the PN-EN ISO 3696:1999, ASTM, CLSI standards for II and III class. BASIC deionizers are a perfect source of high quality water for salt chambers, climatic chambers, etc.



BASIC 15-25

MODELS

Models	Dimensions [mm]	Bed volume l	Catalogue no.
Basic 5	235x440x510	5	DB-005-OK
Basic 10	270x470x570	10	DB-010-OK
Basic 15	250x320x1200	15	DB-015-OK
Basic 25	250x320x1310	25	DB-025-OK

General information:

- Powered by: tap water.
- Volume of the deposit: 5-25 l.
- Working capacity: 28g CaCO₃/1l.
- Conductivity: 0,06-0,8 μS/cm.

Standard:

Water purified in this device fits the PN-EN ISO 3696:1999 standard for II and III purity class.

Application:

Basic water for general laboratory purposes; obtained water may be used for preparations of mediums, buffer solutions, reagents; may be used as a source for other laboratory devices: environmental chambers, cleaning demineralizers.

Technical specification:

- Device operates under tap water pressure
- Water purification levels:
 - sediment-carbon filtration,
 - ion exchange filtration.
- Conductivity of obtained water (dependable on tap water flow): 0,06 - 0,8 μS/cm.
- Water intake point – II purity class, according to PN-EN ISO 3696:1999, equipped with a demi water nozzle of a min. 2 m reach.
- User-performed maintenance procedures (easy disposables replacement).
- Can be connected to a climate chamber etc.
- Power supply: 230V/50Hz.
- Optional user-performed device installation.
- Monitoring message/alarm preview.

Monitoring functions

- Equipped with a microprocessor control and measurement system:
 - LCD display screen 2x16 characters,
 - conductometer measuring conductivity and temperature of demineralized water (in μS/cm or MOhm),
 - displaying values compensated and uncompensated thermally,
 - clock displaying date and time,
 - alarm informing about the necessity to replace the mechanical and activated carbon filters,
 - alarm informing about the necessity to replace the mixed bed,
 - service dates via,
- Installed RS 232 connector intended for the communication with a PC, allowing to adjust the service frequency and alarm levels.
- Built-in manometer measuring feed water pressure.

Feed water parameters:

- Conductivity < 1200 μS/cm.
- Pressure > 3,0 bar.
- Temperature: 4-40°C.
- Hardness < 250 mg CaCO₃/dm³
- Fe < 0,2 mg/dm³

Required connections:

- cold tap water ½" or ¾",
- 230V socket.

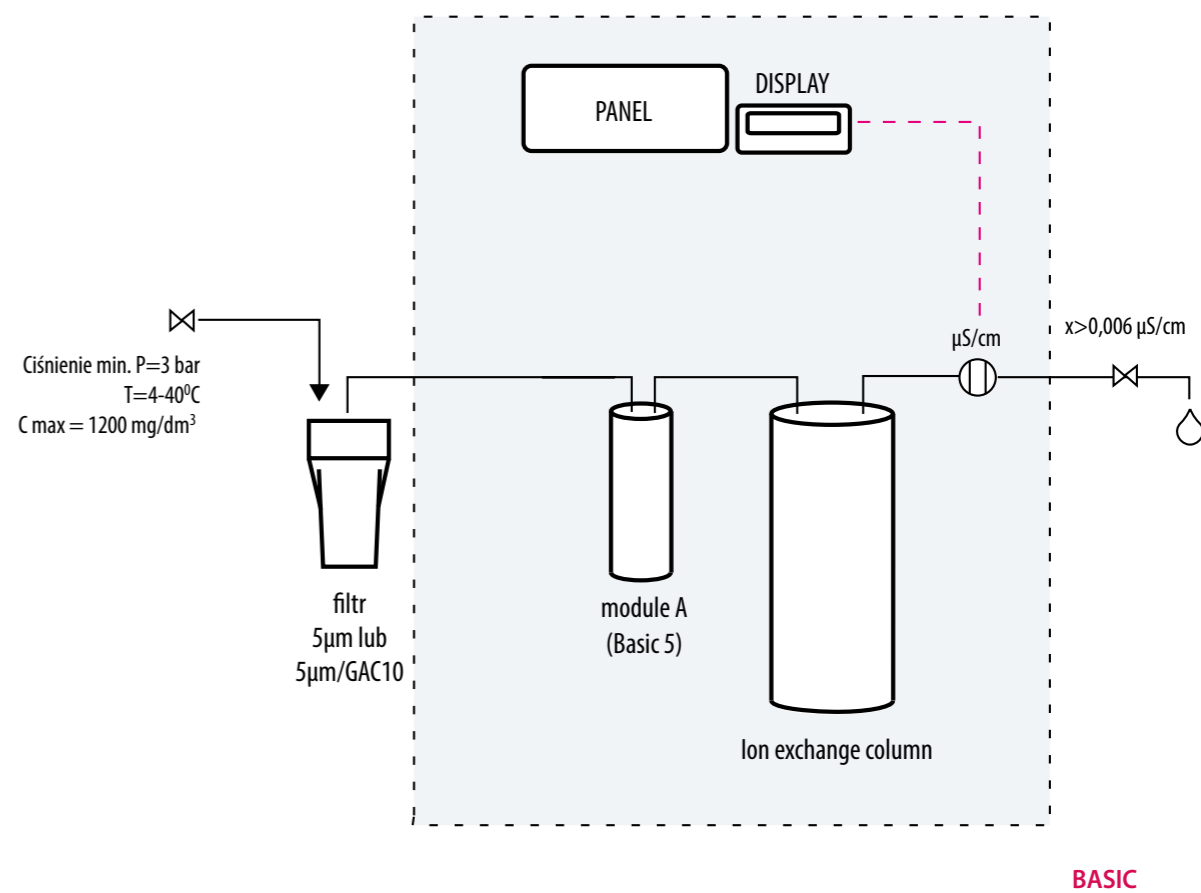



INDUSTRY

TECHNICAL

Water treatment systems with an industrial capacity of 100 to 1000 dm³ / h. The stations allow receiving purified water of the third* purity class according to ISO 3696: 1999.

** depends on feed water quality, retention rate is 96-99%*

SPRING

Water treatment systems with an industrial capacity of 100 to 1000 dm³ / h. The stations allow obtaining high purity water that meets the requirements of ISO 3696: 1999, ASTM for first, second and third degree purity waters and in accordance with FP.

Each device is designed and manufactured to meet individual customer needs. These devices can be used in the industry (pharmaceutical, food, cosmetics, electronics, etc.) as a central unit producing demineralized water. The demineralizer, by distributing an appropriate network, can supply several laboratory rooms or floors in the building, as well as point laboratory devices.

Models	flow intensity [l/h]	Catalogue no
SPRING 100	100	100DS-TOC-00
SPRING 200	200	200DS-TOC-00
SPRING 300	300	300DS-TOC-00
SPRING 500	500	500DS-TOC-00
SPRING 700	700	700DS-TOC-00
SPRING 1000	1000	1000DS-TOC-00

Models	flow intensity [l/h]	Catalogue no
TECHNICAL 100	100	DT-0100-0C
TECHNICAL 200	200	DT-0200-0C
TECHNICAL 300	300	DT-0300-0C
TECHNICAL 500	400	DT-0500-0C
TECHNICAL 700	700	DT-0700-0C
TECHNICAL 1000	1000	DT-1000-0C



PLUS SERIES



Plus series stations are devices used in tap water softening, preparing it for further treatment by our HLP, Technical, Spring demineralizers. They remove ions of calcium and magnesium from water.

A resin is treated by cyclic regenerations, so it can be replenished to its initial performance of water softening – the system is able to operate over many years.

Resin regeneration is fully automated, performed every defined volume.

Technical specification:

- powered by tap water,
- efficient 5 µm sediment filter
- ion exchange resin – strong acid cationite,
- resistant to corrosion tank made of glassfiber,
- modern controlling head,
- temporal resin regeneration,

MODELS

Models	flow intensity [l/h]	dimensions [mm]	Catalogue no.
HLP Plus V10	2000	345x803x573	DP-020-0V
HLP Plus V20	2600	345x1084x573	DP-026-0V
HLP Plus V30	3200	345x1084x573	DP-032-0V



SERVICE

Hydrolab's water purification devices are powered by tap water of a different quality. Thanks to several protection methods and process stages, we are able to provide the highest quality water for laboratory purposes. All of the stages are controlled, monitored and archived, so the service is effective, and its costs - optimized.

Correct system performance relies on a regular service and maintenance, as well as good communication between the user and an authorized service point.

SERVICE

Standard replacement of disposables is performed by the user. Hydrolab's devices inform the user, when the disposables will expire. The replacement may be performed manually by the user, and the materials are delivered within 24 hours after a request.

Service contract

Service contract ensures the User that the device inspection will be performed regularly on a planned time, guaranteeing a stable and efficient system work. We also extend the warranty and provide extra discounts.

Periodic inspection

All maintenance and service procedures can be planned individually with the user. It is Hydrolab's task to monitor all maintenance and preservation works.

Service calls

Our service is able to react in a time that does not exceed 24 hours. Service procedures are adjusted individually to the user's requirements and needs. We guarantee our service protection all over the country.

Periodic inspection

Inspection in the Hydrolab Service Department is time and cost effective. Hydrolab Service Department is responsible for the collection and delivery logistics. We provide a substitute system for the inspection time.

Validations

Hydrolab's service guarantees full range of qualification process: installation (IQ), operational (OQ) and process (PQ). It is documented and made by Hydrolab.

Modernization and improvement

The user's requirements may change over time. Thus, we are constantly improve current devices. We also design and build demi water network.

Protection, monitoring, inspection

We guarantee constant service protection during the warranty and post-warranty period, and full documentation (for example for an audit purpose). Each user has access to the Registration Card, made individually for every device made by Hydrolab, containing all necessary information (parameters, services, disposables deliveries, installations etc.)

SPARE PARTS

PREFILTER 10"
5 µm
EO-005-10



MODULE
A2
EO-MA-12



CARBON FILTER
GAC 10"
EW-001-10



SEDIMENT-CARBON
PREFILTER
10"
EOW-011-10



SOFTENING
CARTRIDGE 10"
EZ-001-10



IRON REMOVAL
CARTRIDGE 10"
EF-001-10



ION-EXCHANGE
CARTRIDGE
H7
EJ-2000-0



ION-EXCHANGE
CARTRIDGE
H7 TOC
EJ-2000-1



ION-EXCHANGE
CARTRIDGE
H6
EJ-5000-0



ION-EXCHANGE
CARTRIDGE
H6 TOC
EJ-5000-1



RO MODULE
RO D100
ER-RO-0100



RO MODULE
RO D400
ER-RO-0400



MICROFILTRATION
CAPSULE
0,2 µm 150 cm² CE
EM-SP-20



ULTRAFILTRATION
CAPSULE
HLP
EU-HLP-02



ULTRAFILTRATION
MODULE
EU-HLP-01



UV LAMP
RADIATOR
UV 185 nm HLP
EUV-185 -HLP



UV 254 nm HLP
EUV-254 -HLP

UV 185/254 nm HLP
EUV-185-254 -HLP

ACCESSORIES

SOLENOID VALVE
24V
A-EZ-2414



WATER DEMI TAP GRAY
A-KR-TOF-001



FILTER HOUSING 10"
A-OP-010-W



CONNECTION TO AN ANOTHER DEVICE
3/4" **A-PZ-034**
1/2" **A-PZ-012**
3/8" **A-PZ-038**



SPIRAL HOSE
A-KR-001B



LOW PRESSURE SENSOR
A-CNC-T



PRESSURE TANK
10L **ZC-0010**
40L **ZC-0040**
80L **ZC-0080**



GRAVITY TANK INOX
30L **ZG-030-INOX**
60L **ZG-060-INOX**



HIGH PRESSURE SENSOR
A-CWC-T



UV LAMP SLEEVE HLP
EUVO-254HLP



TABLE FAUCET
A-KR-TOF-1



TEMPORAL DOSAGE
W-DW-OT



MEMBRANE PUMP
24V 50GPD
A-P-024-050



MEMBRANE PUMP
48V 100GPD
A-P-048-100



PRESSURE TANK
110L **ZC-0110**
150L **ZC-0150**
OR MORE



DEMI WATER FAUCET WITH INOX (set)
A-KR-TOF-111



ADDITIONAL PARTS



hydrolab.eu



HYDROLAB®

1 Wesola Street
Straszyn 83-010

ph. +48 58 341 16 69
ph. +48 58 341 90 00
fax +48 58 585 86 97

www.hydrolab.eu

biuro@hydrolab.pl
serwis@hydrolab.pl