



ACHIEVER™ 5000

Overhead Stirrers



Reliable Overhead Stirrers with Excellent Performance for Everyday Use

OHAUS Achiever 5000™ Overhead Stirrers are designed for powerful, precise stirring, safety and simplicity in all applications. The sealed design has an IP54 rating and ensures safe mixing performance even in the most demanding applications. The keyless chuck and software controlled speed ramping provide easy set up and safe stirring to protect the sample and user. Select from five models with up to 200 Ncm torque and up to 100 L volume capacity.

Unique Features:

- Powerful mixing and constant speed is assured with the brushless motor and torque compensation technology - delivering accurate, controlled stirring of viscous liquids with quiet operation.
- Simplify set up with the Keyless Chuck - no tools required. Change shafts quickly and easily with one handed operation. This unique design will save time and effort for everyone in the lab.
- Designed for safety. The lock button prevents accidental speed changes and the motor's overload sensing technology simply shuts off stirring before an overload condition occurs to protect the sample.
- Compact and easy to use. Simple knob control combined with the bright digital display allows for precise setting and monitoring. Customize for your application with over 12 accessories.

ACHIEVER™ 5000 *Stirring Shafts*



FLOATING BLADE

30586777

Good for narrow neck vessels

Flow	Stir Speed RPM	Viscosity	Blade
Radial	250 – Max	0 - 1 000 cP	93 x 11 mm
Overall Length	Shaft Diameter	Material	
400 mm	7 mm	316 Stainless Steel	

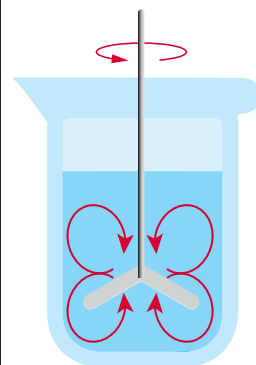

FIXED BLADE

30586776

Good for high speed, low viscosity mixing.
Can create a vortex.

Flow	Stir Speed RPM	Viscosity	Blade
Radial	250 – Max	0 - 10 000 cP	50 x 10 mm
Overall Length	Shaft Diameter	Material	
400 mm	7 mm	316 Stainless Steel	

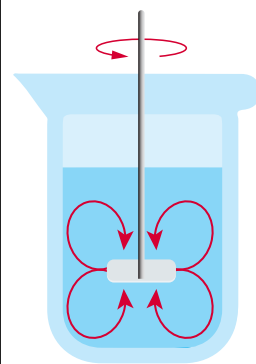

FOLDING BLADE

30586778

Good for narrow neck vessels

Flow	Stir Speed RPM	Viscosity	Blade
Radial	250 – Max	0 - 1 000 cP	60 x 15 mm
Overall Length	Shaft Diameter	Material	
400 mm	7 mm	316 Stainless Steel	

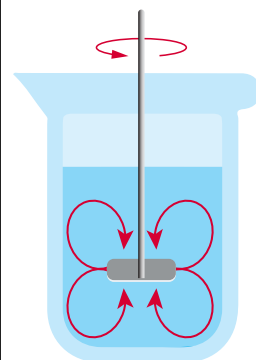

TURBINE

30586781

Teeth break down agglomerations to help
with dispersion. Provides very high shear.

Flow	Stir Speed RPM	Viscosity	Blade
Radial	250 – Max	1 000 - 100 000 cP	49 x 10 mm
Overall Length	Shaft Diameter	Material	
400 mm	7 mm	316 Stainless Steel	

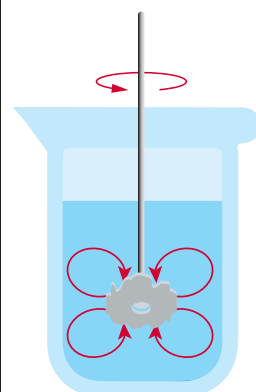

ACHIEVER™ 5000 *Stirring Shafts*



PROPELLER

30586780

Can be used at high speed with medium or high viscosity materials. Excellent mixing properties for homogenization and suspensions.

Flow	Stir Speed RPM	Viscosity	Blade
Axial	250 – Max	0 - 10 000 cP	60 x 9 mm

Overall Length	Shaft Diameter	Material
400 mm	7 mm	316 Stainless Steel

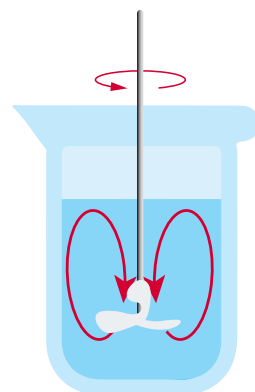

TURBO PROPELLER

30586782

Ring protects dip tubes or sensors in vessel

Flow	Stir Speed RPM	Viscosity	Blade
Axial	250 – Max	1 000 - 100 000 cP	46 x 14 mm

Overall Length	Shaft Diameter	Material
400 mm	7 mm	316 Stainless Steel

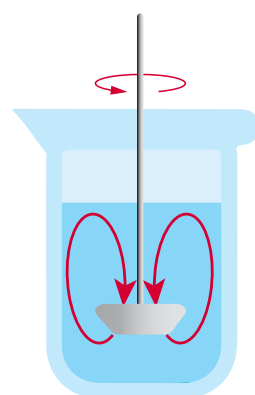

PADDLE, 6 Holes

30586779

For use at low to medium speeds. Ideal for gentle mixing.

Flow	Stir Speed RPM	Viscosity	Blade
Tangential	Up to 800	0 - 10 000 cP	69 x 75 mm

Overall Length	Shaft Diameter	Material
510 mm	7 mm	316 Stainless Steel

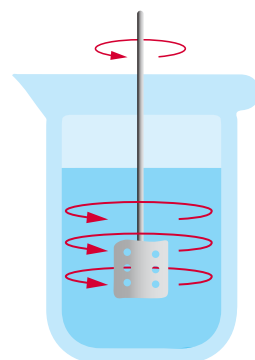

ANCHOR

30586775

Suitable for medium or high viscosity materials. Should be used at low speeds for high viscosity materials.

Flow	Stir Speed RPM	Viscosity	Blade
Tangential	All Speeds	1 000 - 100 000 cP	45 x 54 mm

Overall Length	Shaft Diameter	Material
400 mm	7 mm	316 Stainless Steel

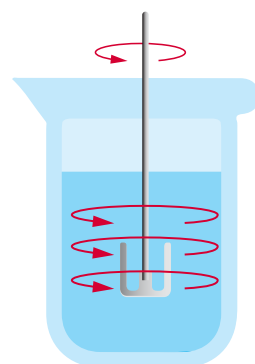

ACHIEVER™ 5000

Model	e-A51ST020	e-A51ST040	e-A51ST060	e-A51ST100	e-A51ST200
Stirring Speed Range	30-2000 rpm			30-1300 rpm	6-400 rpm (I) 30-2000 rpm (II)
Stirring Volume (H ₂ O)	up to 25l		up to 40l	up to 100l	
Maximum Viscosity (cP or mPa's)	10 000	25 000	50 000	70 000	100 000
Maximum Torque (Ncm)	20	40	60	100	200
Speed Gears	1				2
Speed Accuracy	1 rpm				
Speed Control	Digital				
Display	LED				
Timer	Yes				
Lock Button	Yes				
Chuck Range (Diameter)	1 - 13 mm				
Shaft Pass Through (Diameter)	up to 8,5 mm				
Ingress Protection	IP54				
Dimensions (H x L x W)	28,5 x 23,5 x 9,0 cm				31,5 x 23,5 x 9,0 cm
Net Weight	4,1 kg				4,6 kg
Power Supply	230V, 50/60Hz				
Power Input	190W (230V)				
Working Environment	5 °C – 40 °C, 80 % RH, non-condensing				

*RH = Relative Humidity

Dimensional Drawings

e-A51ST020, e-A51ST040, e-A51ST060, e-A51ST100

e-A51ST200

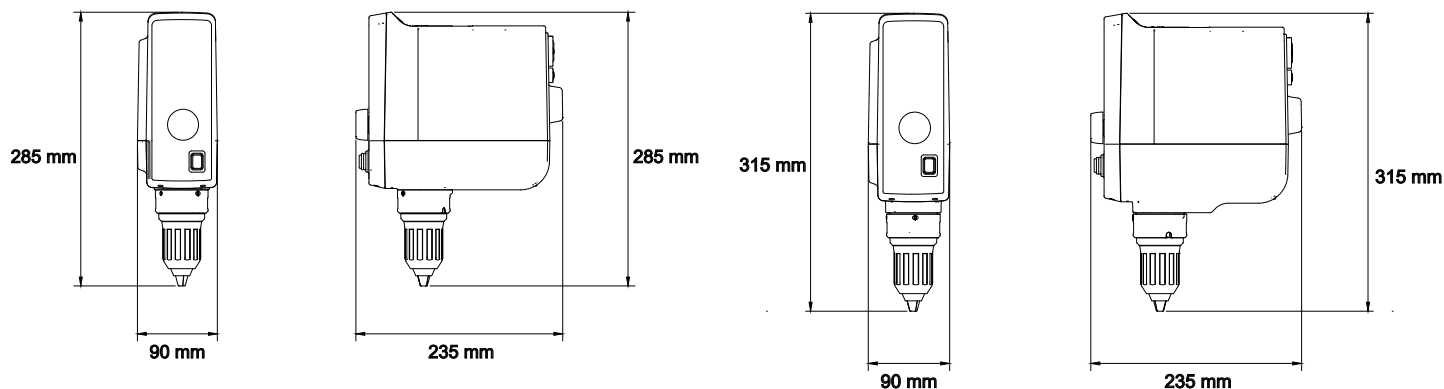

Other Standard Features & Equipment

Stirring from 6 rpm to 2000 rpm with speed accuracy of 1 rpm and maximum torque from 20 Ncm to 200 Ncm depending on model, stable torque at any speed, and volume capacity ranging from 25l to 100l. Support stand and clamp required for set up (sold separately).

Compliance

- Product Safety: CAN/CSA C22.2 No. 61010-1, CAN/CSA C22.2 No. 61010-2-051, EN 61010-1, EN 61010-2-051, IEC 61010-1, IEC 61010-2-051, UL 61010-1, UL 61010-2-051
- Electromagnetic Compatibility: EN 61326-1: 2013 Class A Industrial Environment; Canada ICES-003 Class A; FCC Part 15 Class A
- Compliance Marks: CE; RCM; cNus; WEEE; CN RoHS

Accessories

Support Stand Universal-H	30586771
Support Stand Telescopic-H	30586772
Clamp Double	30586773
Clamp Ribbon	30586774
Chuck Cover e-A51	30586842

A new set up requires: an Achiever unit, a Support Stand, a Clamp Double to secure the unit to the stand, and the appropriate Stirring Shaft that suits the application.

OHAUS Europe GmbH
Heuwinkelstrasse 3
8606 Nänikon
Switzerland

e-mail: ssc@ohaus.com
Tel: 0041 22 567 53 19
e-mail: tsc@ohaus.com
Tel: 0041 22 567 53 20

www.ohaus.com

OHAUS Corporation is an ISO 9001:2008 manufacturer

ISO 9001:2008
Registered Quality
Management System

80776606_B 20200819 © Copyright OHAUS Corporation

