

VWR® PCR Workstation HEPA

INSTRUCTION MANUAL



European Catalogue Numbers:

Euro Plug: 732-3409

UK Plug: 732-3410

Version: 1.2

Issued: 19 September 2018



Legal Address of Manufacturer

United States

VWR International, LLC
100 Matsonford Rd
Radnor, PA 19087
800-932-5000
<http://www.vwr.com>

Europe

VWR International bvba
Researchpark Haasrode 2020
Geldenaaksebaan 464
B-3001 Leuven
+ 32 16 385011
<http://be.vwr.com>

Country of origin Germany

CONTENTS

INTRODUCTION	3
GENERAL WARNING	3
SAFETY INSTRUCTIONS	3
DELIVERY CONTENTS	5
UNPACKING	6
ASSEMBLING THE PCR WORKSTATION	7
SPECIFICATIONS	10
VWR PCR Workstation	10
Power supply	10
CONNECTIONS	11
AC power inlet	11
AC power outlets	12
OPERATING THE PCR WORKSTATION	13
Use of PCR equipment inside the workstation	13
Operating the overhead UV and white lights	13
Operating the UV Air Recirculator	13
Operating the HEPA/UV System	14
Timer	14
Control panel description	15
Select day and time	16
Software menu	16
Set up UV Surface time	16
Set up Auto Decontamination routine	17
Checking and resetting the hours of duty	19
Settings	20
MEASURING UV TUBE INTENSITY	22
Bacterial destruction chart	23
MAINTENANCE	24
Care and cleaning	24
Replacing the UV germicidal or white light tubes	24
Replacing the UV Air Recirculator UV tube	25
Replacing the HEPA/UV tube	25
Replacing the filter of the UV Air Recirculator	25
Replacing the HEPA and Carbon filter	25
Replacing the Pre-filter	26
Replacing the fuse	26
ORDERING INFORMATION	27
TECHNICAL SERVICE	27
WARRANTY	27
COMPLIANCE WITH LOCAL LAWS AND REGULATIONS	27
DISPOSAL INSTRUCTION	28

INTRODUCTION

The VWR PCR Workstation is designed as an ideal environment for the manipulation of DNA and RNA, especially for the set-up of PCR assays. Contamination can lead to false or misleading results which costs time and money. The VWR PCR Workstation minimises the risk of contamination. It provides a 'separate room', e.g. for the set-up of PCR reactions. In addition, the HEPA filter (H14 Standard) provides a barrier against dust, bacteria and mold with a filtration efficiency of 99,995% down to 0.3 microns of particles. The HEPA system provides an ultra-clean particle free working space reducing the chance of contamination by the air which blows into the PCR chamber.

The high intensity surface UV tubes inactivate DNA as a source of contamination between experiments. In addition, a UV Air Recirculator is integrated into the workstation system which reduces airborne contaminants during experiments. UV light is effectively blocked by solid polycarbonate screens to ensure maximum protection for the user.

The surface of the workstation is constructed of stainless steel, which is very robust and can easily be cleaned plus has an antimicrobial effect.

The VWR PCR Workstation offers a controlled environment for PCR and RNA applications that protects your samples and helps to achieve optimal results.

GENERAL WARNING

The PCR Workstation has been designed for laboratory use and it should not be used at temperature below 15 °C. If the instrument is at a temperature below 10 °C place it in a warmer room and wait at least two hours before using it. Before plugging the instrument into a power supply, check that the voltage and frequency on the label matches the power supply specifications. Before any operation ensure that the ventilation grids are not obstructed and the door is properly closed.

SAFETY INSTRUCTIONS

The PCR Workstation is designed with function, reliability, and safety in mind.

Before using the PCR Workstation please read this entire manual and strictly follow the safety instructions!

Caution: The unit includes shortwave UV, which is a powerful source of UV radiation that will cause damage to unprotected eyes and skin if directly exposed to the UV lamps. Before operating any unit, ensure that the PCR Workstation is not damaged, and that instructions for use of this equipment are followed. A safety shut-off switch automatically turns the UV light off when the front panel is open, protecting users from UV exposure. The polycarbonate panels are UV-blocking.

Intended use of the PCR Workstation: Working environment for protection of PCR reactions / reaction set ups and genetic substances against pollution and contamination.

Safety and protection of the user cannot be ensured if the PCR Workstation is used in any manner that is not specified in these instructions. Special notice must be taken of the following:



Caution: Dangerous voltage

Ensure that the voltage requirements of the PCR Workstation exactly match your local AC power supply.

Only use the original AC cable supplied with the PCR Workstation.



Caution: Liquids

Ensure that no liquids can enter the device. Do not place liquids on top of the PCR Workstation.



Caution: Dangerous explosive material

Do not use reactive or explosive substances in the PCR Workstation.



Caution: Damage

Check for transport damage and completeness of the accessories upon arrival. If any damage is noticed, contact your distributor or manufacturer immediately. If you detect any damage of the PCR Workstation or one of its accessories, do not connect the PCR Workstation to the AC wall outlet and do not use the device in any manner!



Caution: Optical radiation

Do not switch on the PCR Workstation if not completely assembled. See "ASSEMBLING THE PCR WORKSTATION", page 7.
Do not look directly into the UV lamps.

DELIVERY CONTENTS

After receipt of the system, please check if the following items are included in the shipment:



1. Base (1x)



2. Rear panel (1x)

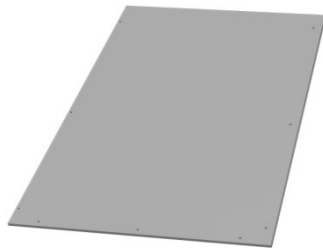

3. Side panel (2x)

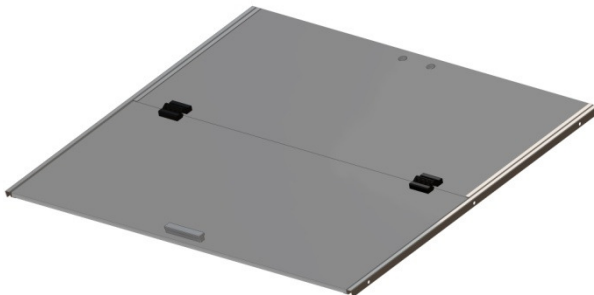

4. Front panel (1x)



5. Shelf (2x)



6. Top assembly (1x)

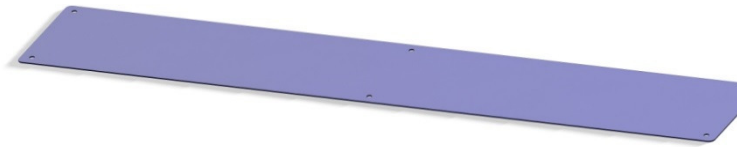

7. Ventilation cover (1x)



8. Screw (31x)



9. Screwdriver (1x)



10. Main cable (1x)



11. Pre-filter (1x)



12. Carbon filter (1x)



13. HEPA filter (1x)

UNPACKING

- Remove the instrument from its packaging and inspect it for signs of damage. If any are discovered, inform your supplier immediately
- The instrument must be placed on a stable, level surface and positioned such that air can circulate freely around the casing
- Ensure your proposed installation site conforms to the environmental conditions for safe operation
- The instrument is designed for indoor use only, temperature range of 10 to 35 °C and humidity of 35 to 70% are recommended

- If the instrument has just been unpacked or has been stored in a cold environment, it should be allowed to come to room temperature for 2 – 3 hours in the laboratory before switching on. This will prevent calibration failure because of internal condensation
- The instrument must be connected to the power supply with the power cord supplied.
- It is recommended that users should thoroughly read this manual prior to use
- Contact your supplier if you experience any difficulties with this instrument

ASSEMBLING THE PCR WORKSTATION

The PCR Workstation should be assembled by two people, directly at the site of operation. We recommend the wearing of safety gloves for hand protection.

Step 1

Put the base ① on an even surface with the rubber feet facing down and the sensor cable outlet facing to the front. Lay the back panel ② onto the base ① with the power outlets facing down, and the power input and the type label facing to the right.

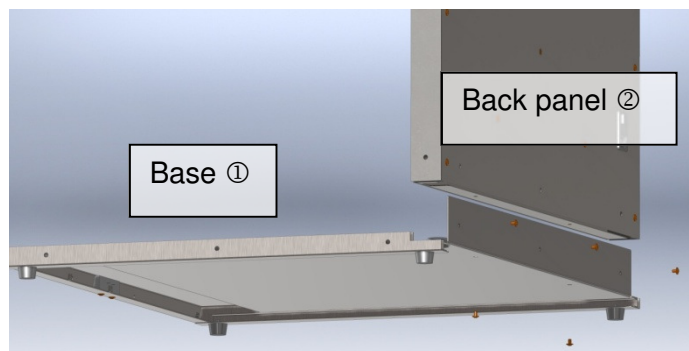

Connect both sensor cables.

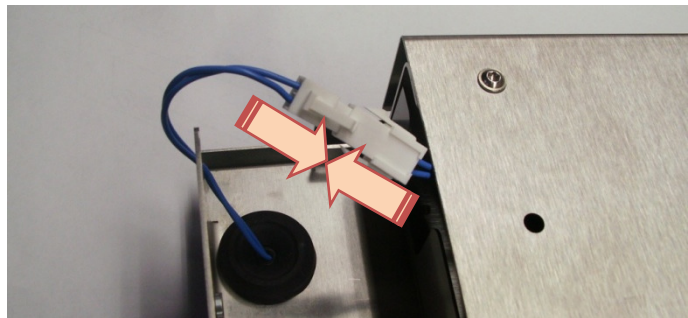

Slide the connection assembly into the cavity of the back panel.

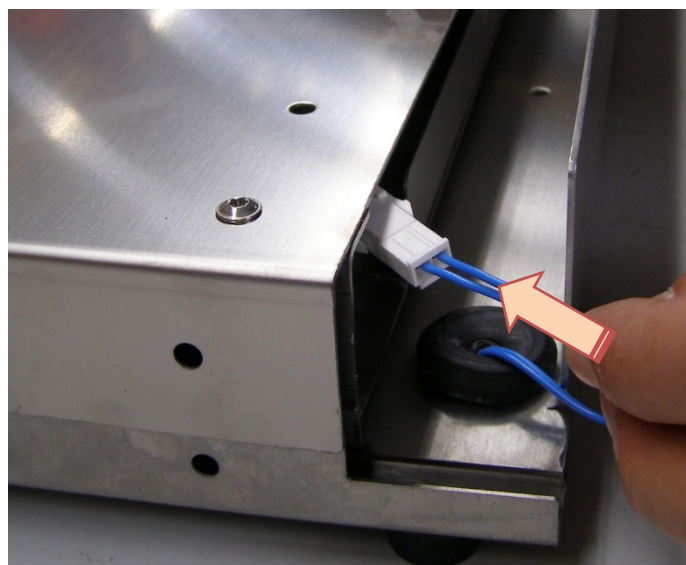

Slot the back panel ② onto the base ①. The connecting link of the base ① must fit in the back panel ②. **Take care not to squeeze the sensor cable.**



Connect both parts by screwing 3 screws ⑧ into the back side. Use the screw driver ⑨ to do this. Turn the parts around 90° on the site of operation and incline both screwed parts to the back part of the back panel ②. Screw both panels with 2 screws ⑧ from underneath. Tilt back the panels in starting position with the back panel facing backwards.

Step 2

Remove the protective foil from the side panels.

Insert the side panels ③ into the guiding rails at the base ① and push up against the back panel ② within the guiding rails at both sides. Carefully screw the side panels ③ with 3 screws each in the base ① and the back panel ②, respectively. Use the supplied screws ⑧ and the screwdriver ⑨.

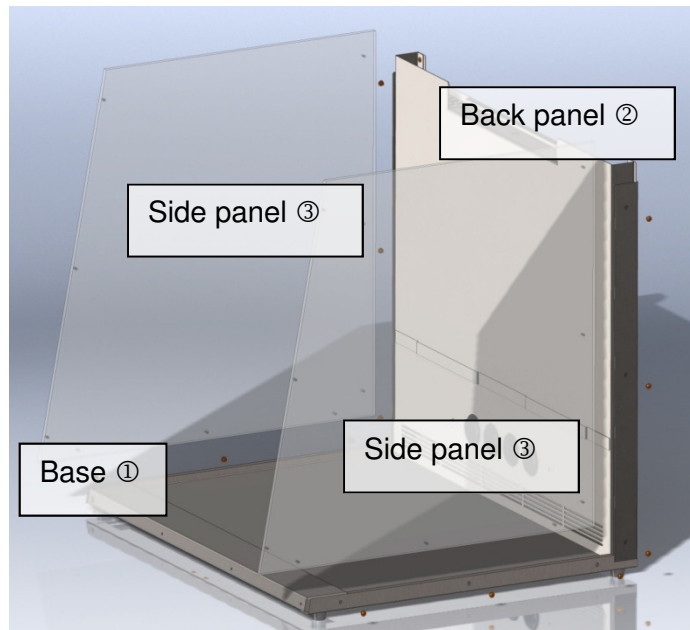

Step 3

Put the shelves ⑤ into the shelf brackets at the back panel ②.

Remove the protective foil from the front panel.
Put the front panel ④ onto the side panels ③.

Take care that the screw holes of the front panel match the threaded holes in the side panels ③. Hold the front panel ④ in place. Screw the front panel ④ to both side panels ③ using 3 screws ⑧ each. Use the screwdriver ⑨.

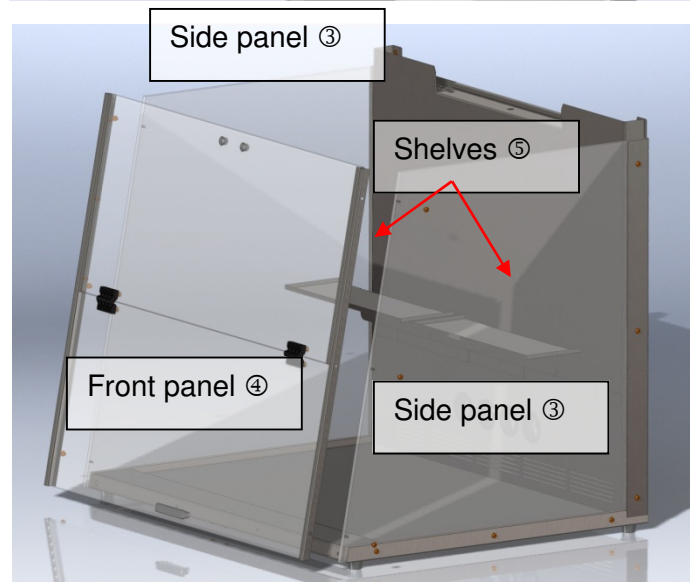

Step 4

Turn the assembled parts around 180°.

Remove the small UV tube at the back of the top assembly.

Put the top assembly ⑥ onto the panels. Take care not to squeeze the cables protruding from the back panel. Screw the top assembly to the back panel ② at two positions. Use the screws ⑧ and screwdriver ⑨ supplied.

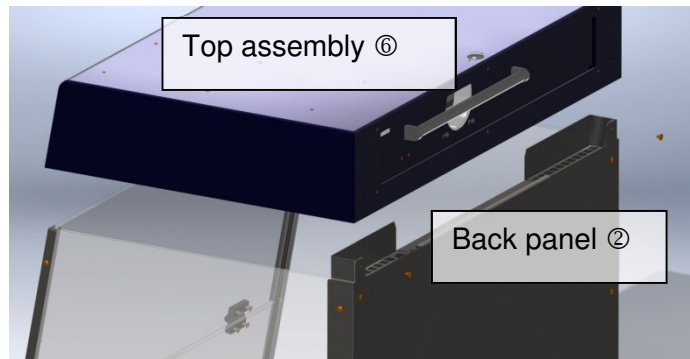

Connect the sensor cables from the back panel ② and the top assembly ⑥. Put the power plug of the back panel ② into the power outlet of the top assembly ⑥.

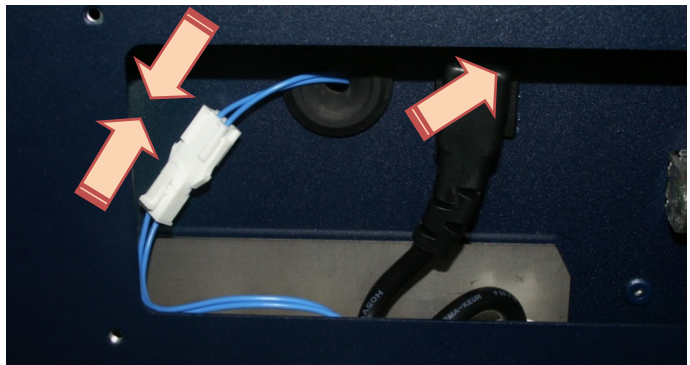

Step 5

Insert the UV tube back in place.

Cover the service access of the top assembly ⑥ with the ventilation cover ⑦. Screw both parts together with 6 screws ⑧. Use the screw-driver ⑨.

Turn the system around 180° and place it at the site of operation as needed.

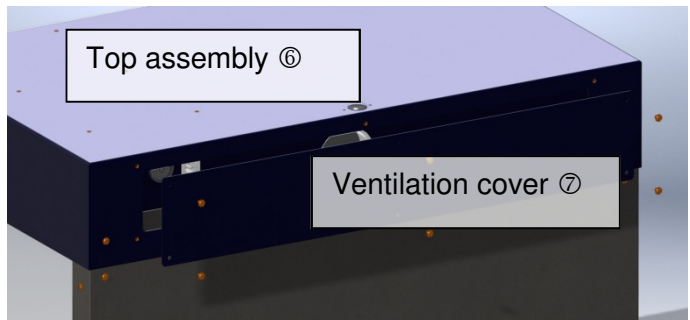

Step 6

Unpack the HEPA filter from foil. Insert the filter (arrow downwards, for correct direction of flow) followed by the carbon filter into the filter cassette. To place the filter cassette into the top assembly move it upwards into the opening and press gently until the handles locks into place.



Finally connect the system to the power supply by plugging the power plug ⑩ from the back panel ② into the local power outlet.

The system is now ready for operation now.

SPECIFICATIONS

VWR PCR Workstation

Light sources integrated into the top assembly:

- 2x 25 W 254 nm UV light tubes – for effective surface decontamination
- 1x 8 W 254 nm UV light tube – for decontamination of air during work in UV Air Recirculator
- 1x 8 W 254 nm UV light tube – for decontamination of air during work with HEPA Filter
- 1x 15 W white light tube – for a bright work surface

Features:

- Four power outlets
- Two shelves made from stainless steel
- Electronic UV timer
- Working area and back panel made from stainless steel
- Front and side panels made from polycarbonate (Makrolon®) that blocks wavelengths below 400 nm
- Three-stage filter system with Pre-filter, Carbon filter and HEPA filter

WxHxD:	750x795x620 mm
Weight:	52 kg
Pollution rate:	2
Environmental temperature range:	+10 to +30 °C
Maximum relative humidity:	70%
Maximum height above sea level:	2000 m
Noise level (at 0,5m/sec):	43 dB (A)
Noise l _{xel} (max):	60 dB (A)
• Circulation rate fan:	56 m ³ /h (UV Air Recirculator) 50 – 250 m ³ /h (HEPA Filter)

Power supply

EU/UK Version :	220 - 240 V AC, 50/60 Hz, max. 1650 VA
US Version :	120 V, 60 Hz, max. 900 VA
Fuse:	10 AT, 5 x 20 mm

For indoor use, only!

CONNECTIONS

AC power inlet

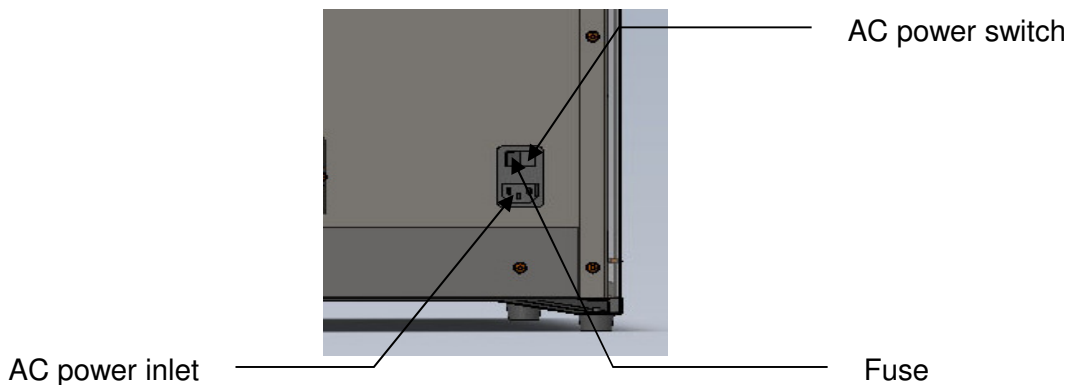

Before first use, ensure that the voltage requirements of the PCR Workstation exactly match your local AC power supply. Connect the PCR Workstation to the AC power supply only by the AC power cord delivered with your PCR Workstation. Only connect the PCR Workstation to electric power systems with an earth conductor. The AC power inlet and the AC power switch are located at the rear of the workstation. The AC power switch serves as a disconnection of the AC power supply from the device. The accessibility of the AC power switch must be not hindered or obscured in any way.

The electric fuse is placed at the back of the device between the power switch and the AC power inlet. After pulling off the AC power cord and pushing upwards a safety catch, the fuse can be changed. Use only a fuse with correct values (see "SPECIFICATIONS", page 10). Indications about the fuse type are also located at the back of the device.

If a service is required, contact your local distributor or the manufacturer (see "TECHNICAL SERVICE AND ORDER INFORMATION", page 27).

The serial number of the PCR Workstation is located at the rear of the instrument. The replacement of single components (except polycarbonate panels, UV tubes and the UV Air Recirculator fuse and filter) must not be done by the user but exclusively by authorised specialists using original replacement parts. Therefore, the device must be sent to the manufacturer. Unauthorised work on the device voids the warranty.

The surface of the device should be decontaminated with a lint-free cloth soaked with 70% ethanol before sending. Please fill in and sign the decontamination certificate and send it to the manufacturer together with the device.

For safety reasons the device must be switched off and the mains plug pulled before cleaning is performed!

AC power outlets



4x AC power outlet

The 4 AC power outlets serve as power supplies for devices used inside the PCR chamber.



The sum of the maximum power ratings of devices connected to these power outlets must not exceed the values specified for the PCR Workstation. See chapter "OPERATING THE PCR WORKSTATION ", page 13, for further information.

OPERATING THE PCR WORKSTATION

Use of PCR equipment inside the workstation

Shelves are provided for the placing of small tools for storage and decontamination.

Power outlets allow use of shakers, rockers and other equipment for PCR experiments inside the PCR chamber. The equipment can be decontaminated between experiments. To operate equipment within the chamber, plug the equipment into the power plug. Specific power plugs are installed as shown in the illustration "AC power outlets", page 12.

Timing of UV decontamination can be programmed for time-controlled every day decontamination.

NOTE: When operating, equipment plugged into the outlets, combined amp total should not exceed 6 amps.

NOTE: Crazeing is a normal process for polycarbonate panels exposed to UV light. Crazeing will occur over a period of time. Reduce crazeing by keeping exposure to UV to a minimum. Crazeing may occur within the warranty period and is regarded as normal wear and tear not covered by the warranty. Polycarbonate panels are available as spare parts and can be replaced.

Operating the overhead UV and white lights

The PCR Workstation provides an automated process for eliminating contamination by using the decontaminating properties of shortwave 254 nm ultraviolet light. The UV light is typically operated when no samples are inside the chamber. The chamber is decontaminated and DNA as a possible contamination is inactivated.

The overhead white light can remain lit at any time throughout an experiment or a decontamination process. The fluorescent white light provides a bright light within the PCR Workstation.

Operating the UV Air Recirculator

The VWR PCR Workstation includes a built-in UV Air Recirculator for elimination of airborne microbes during experiments.

NOTE: The UV Air Recirculator can operate while the front panel is open.

The UV Air Recirculator circulates airflow into and out of the chamber. The air is sucked into the UV Air Recirculator in the top of the chamber, the air outlets are at the bottom of the back panel. The drawing indicates the location of the air vents.

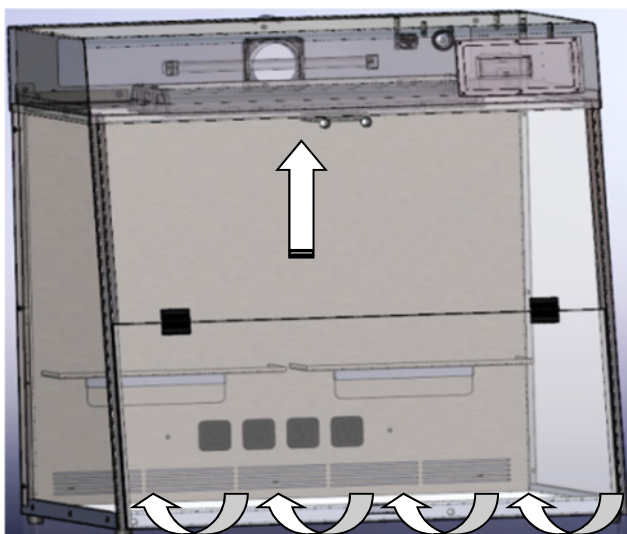

NOTE: Equipment in front of the air vents will block airflow.

Operating the HEPA/UV System



Push the HEPA button to operate the HEPA/UV filter system. The airflow fan setting can be adjusted in four steps (0,3m/s, 0,5m/s (Factory Default), 0,8m/s, 1,2m/s) by pressing the ▲ or ▼ button in the start screen. The UV light starts first followed by the airflow fan, to avoid contaminations from inside of the top assembly.

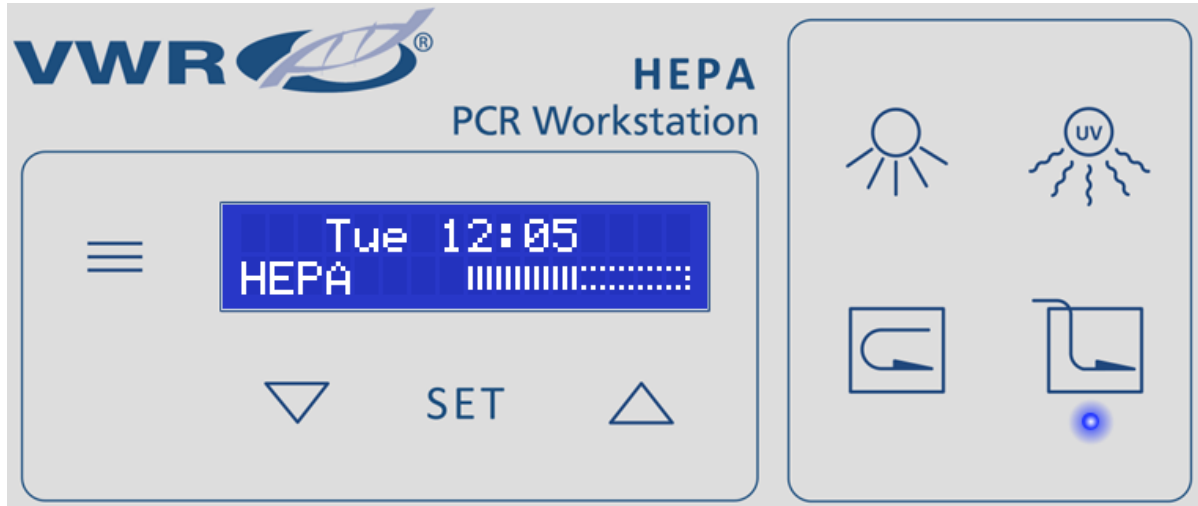

The filter system consists of:

- Pre-filter to preserve the life of other filters by capturing large dust particles
- Carbon filter to remove ozone and gases
- HEPA filter (H14 Standard) provides a barrier against dust, bacteria and mold with a filtration efficiency of 99,995% down to 0.3 microns of particles. The HEPA system provides an ultra-clean particle free ISO-Class 5 working space according to the EN 1822-1 standards.

Timer





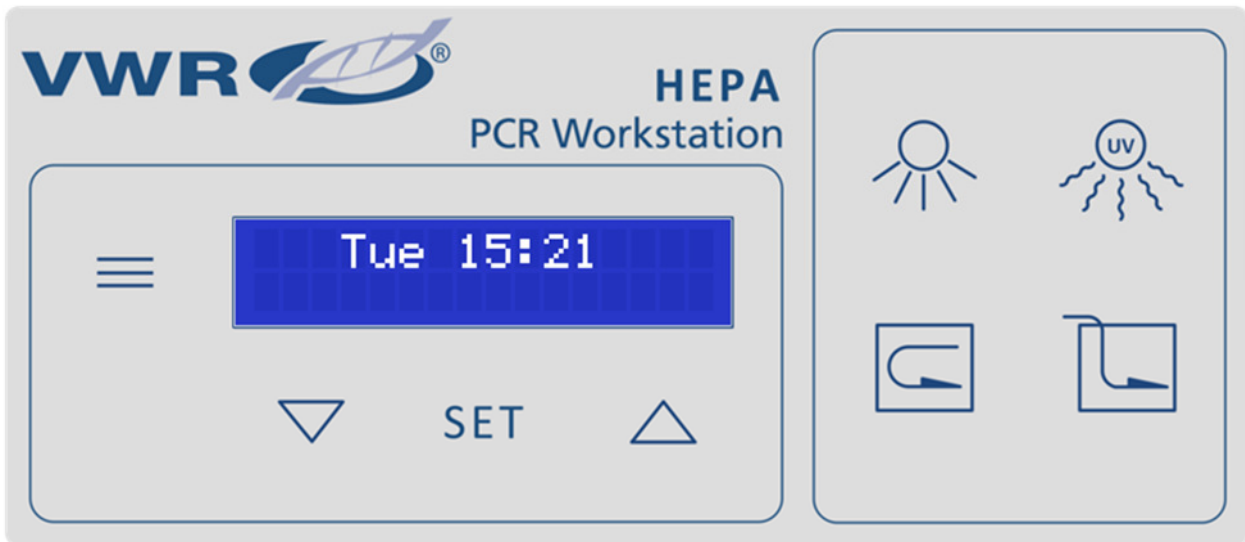

The default setting is 30 minutes adjustable at 5 minutes' increments down to a minimum of 5 minutes. For information on setting the timer please see page 16/17.

Note: A magnetic sensor is built into the bottom of the front panel. When the front panel is opened, the ultraviolet light will automatically shut off!

Note: Do not attempt to perform PCR procedures with the germicidal lamp on. The germicidal lamp is used to decontaminate the chamber between experiments.

Control panel description



	To scroll or increase selected value
	To scroll or decrease selected value
SET	Enables to select and change the displayed program settings. Several clicks to jump from value to value.
	Enables to open and close the software menu
	Switch white light on and off
	Switch UV light on and off It automatically activates the programme to decontaminate the workspace. The default time for the decontamination process is 30 minutes. The display will show the remaining time of the decontamination programme. Remaining time could be change with the arrow buttons.
	Switch Recirculator on and off
	Switch HEPA/UV system on and off

Select day and time

SET

Press **SET** from the home screen to change day and time. Pressing the ▲ or ▼ button will modify the selected value.



Fri 10:52

SET

Press **SET** to go to the next values: hours, minutes and safe.

Software menu



Press  to open the software menu. Pressing the ▲ or ▼ button will go through the menu items. An arrow is displayed near the selected item. The items are:

- **UV Surface**
- **Auto Decontamination**
- **Duty hours**
- **Settings**

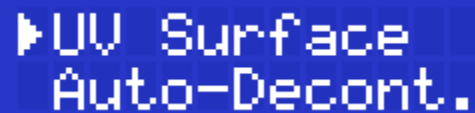

▶ UV Surface
Auto-Decont.

Set up UV Surface time

SET

Select "UV Surface" and click on **SET**. The time starts flashing. Pressing the ▲ or ▼ button will modify the time between 30 min and 5 min in steps of 5 minutes. To store the selected value press

SET



UV Surface
Time 30 min

Set up Auto Decontamination routine

Select "Auto Decontamination" and click on  to set up a daily decontamination routine. The following parameters can be selected



Start time

Weekdays

Functions





Select "Start time" and press . The first value starts flashing.

Pressing the  or  button will modify from OFF to ON. To activate or deactivate the daily decontamination routine.





Press  to confirm and set "hours". Press



 to confirm and set "minutes". Press 

to confirm and set decontamination time between 

30 and 5 minutes in 5 minute steps. Press 

to confirm and store the settings. Press  to go back to the decontamination routine parameters. Select "Weekday" and press . To select the Weekdays the auto decontamination will be activated.



First character is flashing (M = Monday), pressing  or  button will modify the character from active

(filled box) to inactive (empty box). Press 

confirm and select the next day. Press  to confirm and select the next day after selecting the

last value (S = Sunday)  will store the

settings. Press  to go back to the decontamination routine parameters.

Select "Functions" and press **SET**. To select the Functions for the auto decontamination, click on the function buttons on the right panel. A blue light will flash if a function is selected. To save the selection



press **SET**.

Note: During Auto-Decontamination all selected functions will be activated automatically, after reaching the selected time only the UV Light will be deactivated all other functions (HEPA, Recirculator) are still running to protect the device from re-contamination.

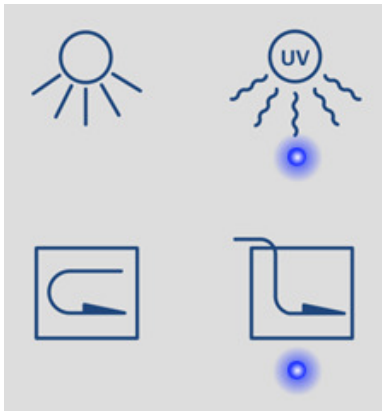

If the HEPA system is activated , select the intensity of the air flow between four levels (0.3m/s, 0.5m/s (Factory Default), 0.8m/s and 1.2m/s). Press the ▲ or ▼ buttons to change the value. Press



SET to confirm and store the settings. Press  to go back to the decontamination routine parameters.

To stop a running Auto Decontamination select



Abort? Yes and press **SET**.

After finalizing an Auto Decontamination run the final Time will be shown in the display, press **SET** to go back to the main screen.



Note: During Auto-Decontamination all selected functions will be activated automatically, after reaching the selected time only the UV Light will be deactivated. All other selected functions (e.g. HEPA or Recirculator) are still active to protect the device from re-contamination.

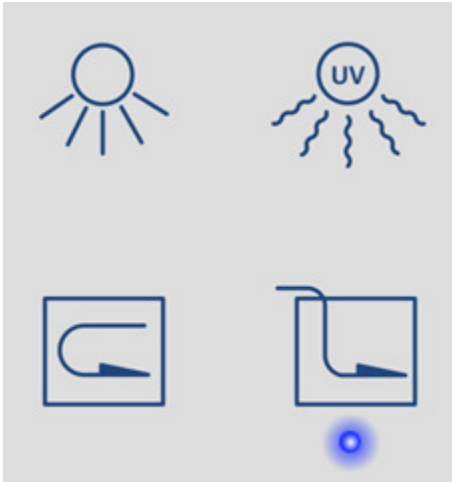

Checking and resetting the hours of duty

SET

Select "Duty hours" and click on . The following parameters can be selected

UV Surface

UV Recirculator

UV Supply Air

HEPA Filter

Carbon Filter



SET

Select one parameter and press on  to see the time of duty. A progress bar will indicate when the device needs to be replaced.

We recommend to change the **UV tubes** after 1000 – 1500 operating hours as the UV intensity decreases significantly after that time.

We recommend to change the **HEPA Filter** after 1500 operating hours (based on the default setting of 0.5 m/sec of the air flow. With less or more power, the runtime is extended or shortened, this will be considered automatically by the runtime clock), or earlier to avoid clogging.

We recommend to change the **Carbon Filter** after 3000 h or once a year.



To reset the Duty hours of the selected parameter,



SET

press on  the progress bar and hours starts flashing.



Press the ▲ or ▼ buttons to change the value to

SET

zero. Press on  to store. Press  to go back to the Duty hours selection parameters.



Reaching the maximum of the recommended operating hours, the UV tubes or filters must be replaced. Those items will be temporary indicated on the main screen tagged by a sandglass (duty hours exceeded). When "duty hours exceeded"

SET

message is displayed, press  to reset the duty hours of the items directly (short cut).



After replacing filters, UV or white light tubes it is necessary to reset the hours of duty in the software manually!

Settings

Select "Settings" and press on . The following parameters can be selected

Brightness

Contrast

Language

Time Format

HEPA Default

Factory Reset





Select "**Brightness**" and press on , a progress bar starts flashing and indicates the brightness of the display. Press the ▲ or ▼ buttons

to change the value. Press  to confirm and

store the settings. Press  to go back to the Settings parameters



Select "**Contrast**" and press on , a progress bar starts flashing and indicates the contrast of the display. Press the ▲ or ▼ buttons to change the

value. Press  to confirm and store the

settings. Press  to go back to the Settings parameters



Select "**Language**" and press on . Press the ▲ or ▼ buttons to modify the selected language. Languages are: English, German, Espanola, Francis, Italian and

Portuguese. Press  to confirm and store the

selected language. Press  to go back to the Settings parameters



Select **“Time Format”** and press on  .
Press the ▲ or ▼ buttons to modify the selected



format between 24h and 12h am/pm. Press  to confirm and store the selected parameter. Press

 to go back to the Settings parameters.

Select **“HEPA Default”** and press on  , a progress bar starts flashing, indicates the default value of the air flow. Press the ▲ or ▼ buttons to select a new default value (0.3m/s, 0.5m/s,0.8m/s





and 1.2m/s). Press  to confirm and store the

settings. Press  to go back to the Settings parameters

Select **“Factory Reset”** and press on  . Press the ▲ or ▼ buttons to select YES or NO for the



reset. Press  to confirm and store the

settings. Press  to go back to the Settings parameters.

The Default parameters are:

Language:	English
Time Format:	24h
Brightness:	60%
Contrast:	60%
UV Surface Time:	30 min
Auto Deco:	OFF

MEASURING UV TUBE INTENSITY

As UV tubes age, intensity and germicidal destruction rate decreases. We recommend you change the UV tubes after 1000 – 1500 hours of operation (please refer to "Checking and resetting the hours of dirty", page 19). Otherwise it is important to monitor the efficiency of the tubes to ensure germicidal requirements are met. The germicidal destruction rate is a function of the UV intensity at wavelength 254 nm and exposure time. The lower the tube intensity, the longer the lamps must be on to accomplish the same objective.

A UV Intensity Meter with 254 nm sensor will allow the user to measure the 254 nm emissions from the tubes. When it is time to measure the UV intensity inside the PCR Workstation, the sensors can be placed on the floor of the PCR Workstation. Close the front panel and turn on the UV tubes. Please refer to the UV radiometer manual on how to perform the measurement. It is recommended that the user records an initial value upon receipt and assembly of the PCR Workstation.

To measure the UV intensity from the UV Air Recirculator tube, open the cover lid on the back of the PCR Workstation and perform the measurement as described in the UV radiometer manual. Wear protective eyewear and shielding when operating the UV Air Recirculator with the ventilation cover open. Replace the cover and screws after the measurement is completed.

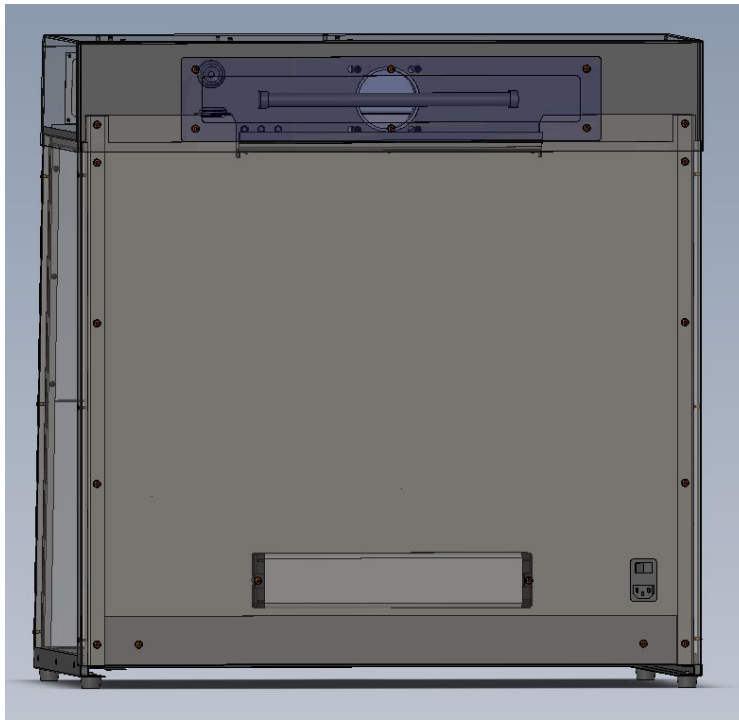

Bacterial destruction chart

The germicidal destruction rate calculation:

$$\text{Microwatt seconds/cm}^2 = \text{microwatts/cm}^2 \times \text{seconds of exposure}$$

The bacterial destruction chart below indicates the amount of shortwave (254 nm) UV energy required for complete destruction of various organisms.

Bacteria	Microwatt seconds/cm ²	Other organisms	Microwatt seconds/cm ²
Bacillus anthracis	8700	YEASTS	
S. enteritidis	7600	Saccharomyces ellipsoideus	13200
B. Megatherium sp. (veg.)	2500	Saccharomyces sp.	17600
B. Megatherium sp. (spores)	5200	Saccharomyces cerevisiae	13200
B. paratyphosus	6100	Brewer's yeast	6600
B. subtilis	11000	Baker's yeast	8800
B. subtilis spores	22000	Common yeast cake	13200
Clostridium tetani	22000		
Corynebacterium diptheriae	6500	MOULD SPORES	
Eberthella typosa	4100	Penicillium roqueforti	26400
Escherichia coli	6600	Penicillium expansum	22000
Micrococcus cadidus	12300	Penicillium digitatus	88000
Micrococcus sphaeroides	15400	Aspergillus glaucus	88000
Mycobacterium tuberculosis	1000	Aspergillus flavus	99000
Neisseria catarrhalis	8500	Aspergillus niger	330000
Phytomonas tumefaciens	8500	Rhisopus nigricans	220000
Proteus vulgaris	6600	Mucor racemosus A	35200
Pseudomonas aeruginosa	10500	Mucor racemosus B	35200
Pseudomonas fluorescens	6600	Oospora lactis	11000
S. typhimusium	15200		
Salmonella	10000	VIRUSES	
Sarcina lutea	26400	Bacteriophage (E. coli)	6600
Sarratia marcescens	6160	Tobacco mosaic	44000
Dysentery bacilli	4200	Influenza	6600
Shigella paradyseneriae	3200		
Spirillum rubrum	6160	PROTOZOA	
Staphylococcus albus	5720	Paramecium	200000
Staphylococcus aureus	6600	Nematode eggs	9200
Streptococcus hemolyticus	5500	Chlorella vulgaris (algae)	22000
Streptococcus lactis	8800		
Streptococcus viridans	3800		

MAINTENANCE

NOTE: Polycarbonate ages in UV light, therefore crazing is considered as a normal process. Crazing will occur with time. Reduce crazing by keeping exposure to UV to a minimum. Crazing may occur within the warranty period and is regarded as normal wear and not covered by the warranty. Polycarbonate panels can be replaced.

Care and cleaning

The front and side panels are made of polycarbonate and are subject to scuffing and scratches if improperly cleaned. Therefore, it is strongly recommended to use a soft cloth (preferentially microfibre) for cleaning.

- Wipe excess water from inside the unit and outside the unit with an absorbent soft cloth or sponge
- Use mild detergent and water with a soft cloth or sponge to clean the exterior and interior of the unit
- Clean the front and side panels with a mild detergent only
- Do not use abrasive pads or cleansers
- A plastic cleaner solution is recommended to clean the front panel and is available from local plastic supply distributors

Never use organic-based compounds like acetone or ammonia containing cleaners for polycarbonate panels!

Due to the specific qualities of polycarbonate panels made of Makrolon® 70% ethanol can be used for cleaning.

Warning: Unplug the unit before cleaning around the UV tube contacts and internal plug outlets.



Warning: Exposure to UV light is harmful.

The polycarbonate front panel blocks UV not allowing UV radiation to pass through the panel. The UV lamp will shut off if the front panel is opened. The PCR Workstation contains a powerful source of UV radiation that will cause damage to unprotected eyes and skin. Before operating any unit, be sure all personnel in the area are properly protected. Even though the unit shuts the UV off when the front panel is open, UV blocking eyewear should be worn as well.

Replacing the UV germicidal or white light tubes

Turn the unit power off and unplug the unit from the power outlet. Lift the front panel and locate the tubes. The tube has two prongs on each end that first fit into a socket, then rotate into place.

Carefully hold the tube at the end and insert the tube into the socket. Twist the tube 90° until the tube locks into place.

Drawing shows tube location in top assembly. Outer tubes are the shortwave 254 nm UV and the middle tube is white light.

We recommend you change the UV tubes after 1000 – 1500 hours of operation.

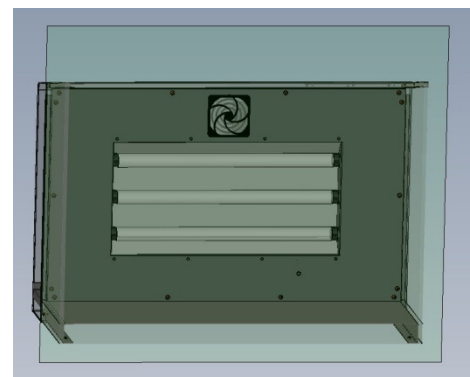

Replacing the UV Air Recirculator UV tube

Locate and remove the six screws on the ventilation cover on the outer back panel of the workstation.

Pull away the ventilation cover from the workstation.

The tube has two prongs on each end that fit into a socket, then rotate into place.

Carefully hold the tube at the ends and insert the tube into the socket. Twist the tube 90° until the tube locks into place.

Replace the cover back into position and reattach the six screws. We recommend you change the UV tubes after 1000 – 1500 hours of operation.



Replacing the HEPA/UV tube

Turn the unit power off and unplug the unit from the power outlet. Locate and remove the four screws on the pre-filter cover on the left side of the workstation.

Pull away the pre-filter and open the security cover by removing the one screw.

The tube has two prongs on each end that fit into a socket, then rotate into place.

Carefully hold the tube at the ends and insert the tube into the socket. Twist the tube 90° until the tube locks into place.

Replace the security cover and the pre-filter back into position and reattach the four screws.

We recommend you change the UV tubes after 1000 – 1500 hours of operation.



Replacing the filter of the UV Air Recirculator

The UV Air Recirculator fan filter is located on the inner top of the PCR Workstation in front of the light tubes (see picture to the right). To change the filter, take off the plastic cover with the filter attached to it and replace it with a new filter. Push the plastic cover back into its location.

Replacing the HEPA and Carbon filter

Turn the unit power off and unplug the unit from the power outlet. Lift the front panel and locate the HEPA filter cassette. The filter cassette has two handles on the left and the right side of the cassette. By pressing and pulling them downward the cassette will be removed and the Carbon and HEPA filters can be replaced.

To load the filter cassette, unpack the filter from foil and add the HEPA filter first (arrow downwards, for correct direction of flow) followed by the carbon filter. To place the filter cassette into the top assembly move it upwards into the opening and press gently until the handles lock into place.

We recommend you change the HEPA filter after 1500 hours of operation. The Carbon filter should be replaced after 3000 h of operation (based on the default setting of 0.5 m/sec of the air flow. With less

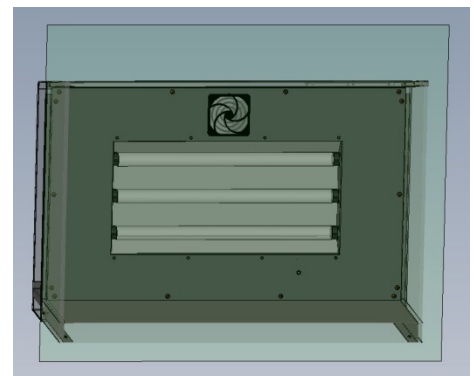

or more power, the runtime is extended or shortened, this will be considered automatically by the runtime clock).

Replacing the Pre-filter

Turn the unit power off and unplug the unit from the power outlet. Locate and remove the four screws on the pre-filter cover on the left side of the workstation.

Pull away the pre-filter and replace the new pre-filter back into position and reattach the four screws.



Replacing the fuse

The fuse is located at the back-right side of the system. To remove the fuse, use a flathead screwdriver to open the lid and pull out the fuse.

Insert the new fuse and using the screwdriver, turn the fuse clockwise to lock.



ORDERING INFORMATION

Article	Description	Cat. No.
PCR Workstation HEPA	VWR PCR Workstation with UV Air Recirculator and HEPA	732-2840 (EU)
UV Bulb	UV Light Bulb for VWR PCR Workstation 1 tube	732-2544 (EU)
UV Bulb	UV Light Bulb for UV Air Recirculator or HEPA/UV system, 1 tube	732-2545 (EU)
WL Bulb	Wight Light Bulb for UV Air Recirculator or HEPA/UV system, 1 tube	732-2543 (EU)
Dust filter	For circulator of VWR PCR Workstation, 10 filters	732-2546 (EU)
Pre-filter	For HEPA/UV system of VWR PCR Workstation, 1 filter	732-3411 (EU)
Carbon filter	For HEPA/UV system of VWR PCR Workstation, 1 filter	732-3412 (EU)
HEPA filter	For HEPA/UV system of VWR PCR Workstation, 1 filter	732-3413 (EU)

TECHNICAL SERVICE

Web resources

Visit the VWR's website at vwr.com for:

Complete technical service contact information

Access to VWR's online catalogue and information about accessories and related products

Additional product information and special offers

For information or technical assistance contact your local VWR representative or visit vwr.com.

WARRANTY

VWR International warrants that this product will be free from defects in material and workmanship for a period of two (2) years from date of delivery. If a defect is present, VWR will, at its option and cost, repair, replace, or refund the purchase price of this product to the customer, provided it is returned during the warranty period. This warranty does not apply if the product has been damaged by accident, abuse, misuse, or misapplication, or from ordinary wear and tear. If the required maintenance and inspection services are not performed according to the manuals and any local regulations, such warranty turns invalid, except to the extent, the defect of the product is not due to such non-performance.

Items being returned must be insured by the customer against possible damage or loss. This warranty shall be limited to the aforementioned remedies. IT IS EXPRESSLY AGREED THAT THIS WARRANTY WILL BE IN LIEU OF ALL WARRANTIES OF FITNESS AND IN LIEU OF THE WARRANTY OF MERCHANTABILITY.

COMPLIANCE WITH LOCAL LAWS AND REGULATIONS

The customer is responsible for applying for and obtaining the necessary regulatory approvals or other authorisations necessary to run or use the Product in its local environment. VWR will not be held liable for any related omission or for not obtaining the required approval or authorisation, unless any refusal is due to a defect of the product.

DISPOSAL INSTRUCTION



This equipment is marked with the crossed out wheeled bin symbol to indicate that this equipment must not be disposed of with unsorted waste.

Instead it's your responsibility to correctly dispose of your equipment at lifecycle end by handing it over to an authorised facility for separate collection and recycling. It's also your responsibility to decontaminate the equipment in case of biological, chemical and/or radiological contamination, to protect from health hazards the persons involved in the disposal and recycling of the equipment.

For more information about where you can drop off your waste of equipment, please contact your local dealer from whom you originally purchased this equipment.

By doing so, you will help to conserve natural and environmental resources and you will ensure that your equipment is recycled in a manner that protects human health.

Thank you

Local VWR offices in Europe and Asia Pacific

Austria

VWR International GmbH
Graumannsgasse 7
1150 Vienna
Tel.: +43 1 97 002 0
Email: info.at@vwr.com

Belgium

VWR International bvba
Researchpark Haasrode 2020
Geldenaaksebaan 464
3001 Leuven
Tel.: +32 016 385 011
Email: vwr.be@vwr.com

China

VWR International China Co., Ltd
Shanghai Branch
Room 256, No. 3058 Pusan Road
Pudong New District
Shanghai, 200123
Tel.: +86-21 589 868 88
Fax: +86-21 585 588 01
Email: info_china@vwr.com

Czech Republic

VWR International s. r. o.
Veetee Business Park
Pražská 442
CZ - 281 67 Stribrná Skalice
Tel.: +420 321 570 321
Email: info.cz@vwr.com

Denmark

VWR International A/S
Tobaksvejen 21
2860 Søborg
Tel.: +45 43 86 87 88
Email: info.dk@vwr.com

Finland

VWR International Oy
Valimotie 9
00380 Helsinki
Tel.: +358 9 80 45 51
Email: info.fi@vwr.com

France

VWR International S.A.S.
Le Périgares – Bâtiment B
201, rue Carnot
94126 Fontenay-sous-Bois cedex
Tel.: 0 825 02 30 30* (national)
Tel.: +33 (0) 1 45 14 85 00 (international)
Email: info.fr@vwr.com
* 0,18 € TTC/min

Germany

VWR International GmbH
Hilpertstrasse 20a
D - 64295 Darmstadt
Freecall: 0800 702 00 07
Tel.: +49 (0) 6151 3972 0 (international)
Email: info.de@vwr.com

Hungary

VWR International Kft.
Simon László u. 4.
4034 Debrecen
Tel.: +36 (52) 521-130
Email: info.hu@vwr.com

India

VWR Lab Products Private Limited
No.139, BDA Industrial Suburb,
6th Main, Tumkur Road, Peenya Post,
Bangalore, India – 560058
Tel.: +91-80-28078400
Email: vwr_india@vwr.com

Ireland / Northern Ireland

VWR International Ltd / VWR International
(Northern Ireland) Ltd
Orion Business Campus
Northwest Business Park
Ballycoolin
Dublin 15
Tel.: +353 01 88 22 222
Email sales.ie@vwr.com

Italy

VWR International S.r.l.
Via San Giusto 85
20153 Milano (MI)
Tel.: +39 02-3320311/02-487791
Email: info.it@vwr.com

The Netherlands

VWR International B.V.
Postbus 8198
1005 AD Amsterdam
Tel.: +31 020 4808 400
Email: info.nl@vwr.com

Norway

VWR International AS
Haavard Martinsens vei 30
0978 Oslo
Tel.: +47 22 90 00 00
Email: info.no@vwr.com

Poland

VWR International Sp. z o.o.
Limbowa 5
80-175 Gdansk
Tel.: +48 058 32 38 210
Email: info.pl@vwr.com

Portugal

VWR International - Material de
Laboratório, Lda
Centro Empresarial de Alfragide
Rua da Indústria, nº 6
2610-088 Alfragide
Tel.: +351 21 3600 770
Email: info.pt@vwr.com

Singapore

VWR Singapore Pte Ltd
18 Gul Drive
Singapore 629468
Tel: +65 6505 0760
Email: sales.sg@vwr.com

Spain

VWR International Eurolab S.L.
C/ Tecnologia 5-17
A-7 Llinars Park
08450 - Llinars del Vallès
Barcelona
Tel.: +34 902 222 897
Email: info.es@vwr.com

Sweden

VWR International AB
Fagerstagatan 18a
163 94 Stockholm
Tel.: +46 08 621 34 00
Email: info.se@vwr.com

Switzerland

VWR International GmbH
Lerzenstrasse 16/18
8953 Dietikon
Tel.: +41 044 745 13 13
Email: info.ch@vwr.com

UK

VWR International Ltd
Customer Service Centre
Hunter Boulevard
Magna Park
Lutterworth
Leicestershire
LE17 4XN
Tel.: +44 (0) 800 22 33 44
Email: uksales@vwr.com