



CLIMATIC AND PHYTOTRON CHAMBERS

Climatic chambers with phytotron system can control temperature, humidity and light to create a stable environment



Climatic chamber KK 500 P Smart PRO FIT DS



All thermostatic equipment manufactured by POL-EKO-APARATURA can be provided with Calibration Certificate issued by accredited Measurement Laboratory. Detailed information on accreditation is available on website: www.pol-eko.eu.



STANDARD FEATURES

- temperature range: 0...+60°C (KK) and 0...+100°C (KKS), +10...+50°C (FIT option with light on)
- quality control protocol (at +25°C, 60%rH)
- English instruction manual
- temperature protection class 3.3 to DIN 12880
- open door alarm
- castors
- LAN and USB ports
- access port (Ø30 mm) on the left wall (at the back in FIT D/DS)
- automatic defrosting function
- deionized water container (for KK)
- door lock
- stainless steel wire shelves (INOX)
- double door (external solid, internal glass)
- Wi-Fi
- LAN cable
- LabDesk software

AVAILABLE VERSIONS

- Smart PRO
- KK with ultrasonic humidifier
- KKS with steam humidifier
- FIT phytotron

SOFTWARE

- LabDesk for downloading data to a computer (via LAN or Wi-Fi)

Application

- growth of plants and fungus
- seeds germination
- microorganisms and insects breeding
- photostability tests
- food preservation tests
- tests of building materials

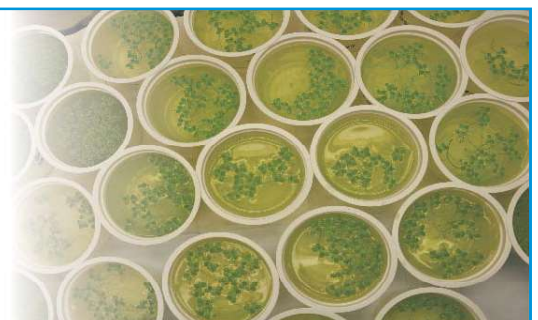

Climatic chambers with phytotron system (* /FIT option) except KKS models

- temperature, humidity and light control
- temperature range with light OFF: 0°C ... +60°C
- temperature range with light ON: +10°C ... +50°C
- light colour selection
- max light intensity 15000 lx per FIT P panel (measured 25 cm under the light source)
- day/night simulation with light intensity control
- fluorescent light tubes located in:
 - door and side walls
 - side walls
 - door
 - over-shelf panels
- LED modules located in:
 - over-shelf panels
 - side walls



FIT D - light tubes installed in door



FIT S - light tubes installed in side walls



FIT DS - light tubes installed in door and side walls

Climatic chambers equipped with phytotron system can control temperature and humidity, as well as light intensity to simulate day and night conditions. Standard light colour is 840 type and the tubes can be installed in the door, side walls or over-shelf panels.

There are also special LED panels designed for plant growing. As most plants use only a part of the sunlight emission, narrow spectrum and specific colours have been used. A and B chlorophyll absorbance maxima are blue and red colour. Chlorophyll absorbs most energy and strongly influences photosynthesis at blue colour spectrum which intensifies growth. Hyper and far red colours stimulate blooming and proliferation.

	KK 115	KK 240	KK 350	KK 400	KK 500	KK 700	KK 750	KK 1200	KK 1450
FIT P	+	+		+	+	+	+	+	+
FIT D	+	+					+		
FIT S			+		+	+			
FIT DS			+		+	+			

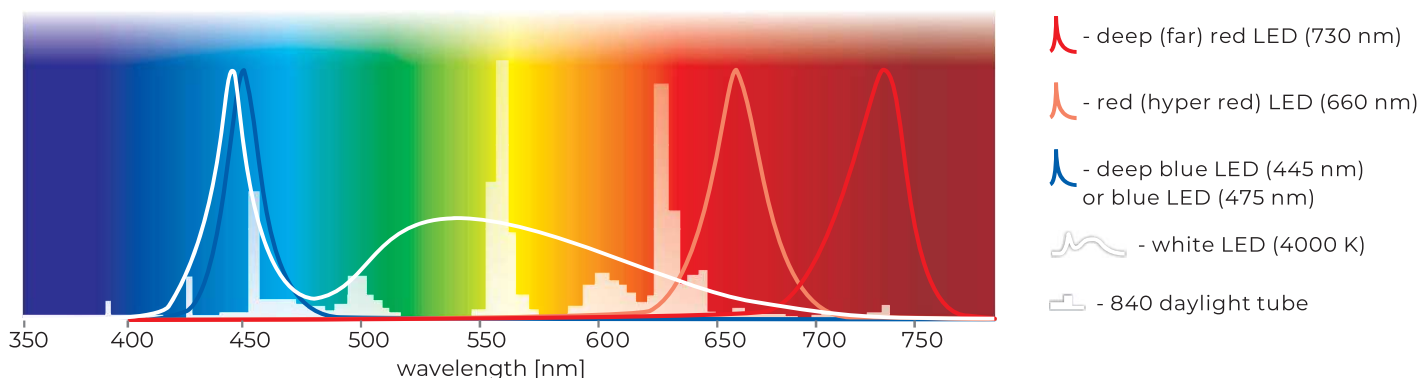

Climatic and phytotron chambers can be adapted to individual customer requirements. A wide range of additional equipment and the possibility of implementing non-standard solutions makes these units satisfy even the most demanding users.



Panel for **FIT P** version



Panel for **FIT P LED** version

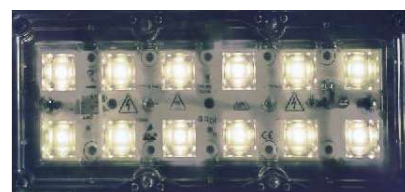

Panel for **FIT P LED White** version

Available fluorescent light tubes

- standard type 840 for daylight simulation
- UV tubes for air sterilization and aging tests

Light intensity of a panel:

- FIT P type 840 ~280 $\mu\text{mol}/\text{m}^2\text{s}$
- FIT P LED white 4000 K ~800 $\mu\text{mol}/\text{m}^2\text{s}$ (25 cm distance from a shelf).

Available LED modules

- red (hyper red) – max for wavelength 660 nm
- deep blue – max for wavelength 445 nm
- blue – max for wavelength 475 nm
- deep (far) red – max for wavelength 730 nm
- white – colour temperature 4000 K

The dimmable over-shelf panels can be provided with several independently controlled colours of light. Other configurations on request.

FIT P version

Climatic chambers with over-shelf panels with light. Depending on the model, there can be between 1 and 3 panels inside the chamber (standard light colour: 840 daylight). The FIT P version includes 1 over-shelf panel and sockets to allow installation of extra panels if required (to be ordered separately).

The FIT/R3 option allows to control the light intensity separately for each panel.

	KK 115	KK 240	KK 400	KK 500	KK 700	KK 750	KK 1200	KK 1450
standard	1	1	1	1	1	1	1	1
max*	1	2	2	3	3	3	3	3
max light intensity on shelf [lx]	FIT version		5000	10000	15000	15000	15000	15000

*max number of over-shelf panels with illumination inside the chamber

FIT P LED version

The user can choose the light colour and intensity for each program segment. The colour modules can be combined, e.g. far red with blue. Dimming allows to set the required level of intensity. This flexibility provides specific light selection for each plant. The LED modules are long-life – after 25000 operating hours they still feature 90% of the nominal efficiency. The unique optics ensures uniform light distribution for each plant. The LED technology also emits very little heat which helps maintain precise temperature inside the chamber.

The FIT/R3 option allows independent control of each panel and/or each light colour.

Climatic chambers

Climatic chambers with an ultrasonic humidifier are professional and reliable equipment to guarantee stable and precise conditions. They can be used for seed germination, fungus and plant growing or food tests. Perfect climatic conditions allow you to perform stability tests of pharmaceuticals and cosmetics, as well as packaging and electronics.

The ultrasonic humidifier uses piezo-electric generators which convert electrical energy into mechanical vibrations energy. The generators are immersed in deionized water and smash it into very small drops which are consequently sprayed uniformly inside the chamber.

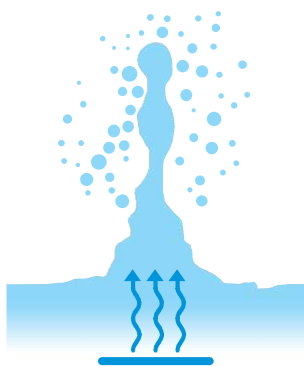









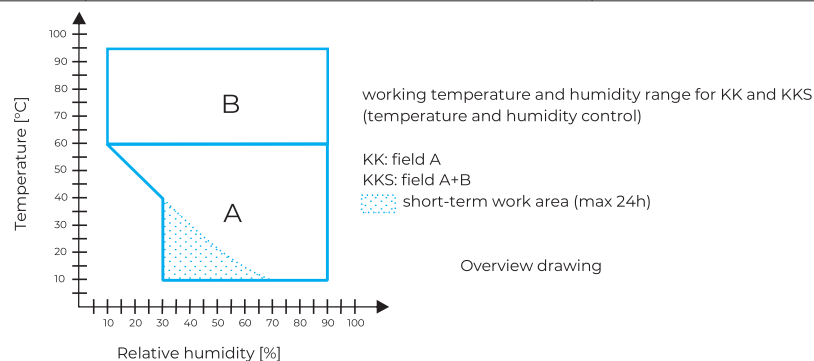

The **KKS climatic chambers** with a steam humidifier do not emit ultrasounds and therefore allow insects breeding (e.g. *Drosophila melanogaster*). Compared to the KK chambers, they feature an extended temperature and humidity range and can be used for tests of electronics, plastic or building materials.

The steam humidifier (steam generator) is a closed boiler that produces steam with higher pressure than atmospheric. The heat required to produce steam is obtained by a heater placed in a boiler. Much higher temperature and humidity range is used in more applications in comparison to KK units.

The KK and KKS climatic chambers can be used for pharmaceutical stability tests according to **ICH Q1A**.

Parameter		Climatic chamber KK with ultrasonic humidifier	Climatic chamber KKS with steam humidifier
temperature range	-	0°C... +60°C	0°C... +100°C
	FIT	0°C... +60°C (+10°C...+50°C with light on)	-
relative humidity range		field "A"	field "A+B"
water supply (conductivity)		deionized (<1 µS/cm)	tap water (125-1250 µS/cm)
water source		<ul style="list-style-type: none"> ■ deionized water container (included) ■ internal deionized water network ■ deionizer 	<ul style="list-style-type: none"> ■ water supply system
outflow		<ul style="list-style-type: none"> ■ container (included) ■ drain system 	<ul style="list-style-type: none"> ■ drain system
power supply		<ul style="list-style-type: none"> ■ 230V 50-60Hz 	<ul style="list-style-type: none"> ■ 230V 50-60Hz ■ 400V 50-60Hz



		KK 115	KK 240	KK 350	KK 400	KK 500	KK 700	KK 750	KK 1200	KK 1450
Parameter										
air convection		forced								
chamber capacity [l]		109	240	322	416	470	600	749	1330	1485
working capacity [l]		109	240	283	416	392	485	749	1132	1264
door type		double (external solid, internal glass) / external glass (option)								
temperature range [°C]	-	0...+60								
	FIT version	0...+60 (with light on +10...+50)								
temperature resolution [°C]		every 0,1								
relative humidity range [%]		30...90 (see working temperature and humidity chart for details on page 70)								
humidity resolution [%]		every 1								
controller		microprocessor PID with external 7" full colour touch screen								
interior		acid-proof stainless steel to DIN 1.4301								
housing	-	powder coated sheet								
	IG	stainless steel linen finish								
overall dims ¹ [mm]	A width	670	830	660	1030	660	750	1270	1480	1460
	B height	1340	1600	2000	1850	1990	1990	2010	1990	1940
	C depth	950	1010	990	1010	1010	1070	1120	1060	1170
internal dims [mm]	D width	460	600	470	800	470	530	1040	1270	1270
	D' width	-	-	510	-	510	600	-	1330	1340
	E height	530	800	1340	1040	1510	1510	1200	1510	1460
	F depth	440	500	500	500	600	650	600	650	750
	I height	-	-	1180	-	1360	1350	-	1330	1270
max shelf workload ² [kg]	-	10	10	10	10	20	30	-	30	30
	PW ³ version	50	100	100	100	100	100	100	100	100
max unit workload [kg]		60	90	100	120	100	150	140	300	300
nominal power [W]		1350	1550	1850	2250	1850	1850	2850	3450	3450
weight [kg]		90	170	125	185	130	170	275	220	230
temperature fluctuation* at +25°C i and 60%rH [±/°C]		2,0	2,0	2,0	2,0	2,0	2,0	2,0	2,0	2,0
temperature variation* at +25°C and 60%rH [±/ %rH]		5,0	5,0	5,0	5,0	5,0	5,0	5,0	5,0	5,0
temperature protection		class 3.3 to DIN 12880								
power supply**		230 V 50-60Hz								
shelves fitted/max		2/7	3/10	3/11	3/14	3/11	3/11	5/16	2 x 3/11	2 x 3/11
refrigerant		R1234ze / GWP=1			R290 / GWP=3					
warranty		24 months								
manufacturer		POL-EKO-APARATURA								

all the above technical data refer to standard units (without optional accessories)

* - fluctuation measured in centre of chamber; in space, variation (K) calculated for chamber as: $K = \pm (T_{avg\ max} - T_{avg\ min}) / 2$

** - other power supplies on request

1 - external dimensions for units without FIT option, depth doesn't include 50 mm of power cable

2 - on uniformly loaded surface

3 - reinforced shelf

OPTIONS AND ACCESSORIES (icon description see page 76-82)



KKS 115 KKS 240 KKS 400 KKS 750



Parameter					
air convection		forced			
chamber capacity [l]		109	240	416	749
working capacity [l]		109	240	416	749
door type		double (external solid, internal glass) / external glass (option)			
temperature range [°C]		0...+100			
temperature resolution [°C]		every 0,1			
relative humidity range [%]		30...90 (see working temperature and humidity chart for details on page 70)			
humidity resolution [%]		every 1			
controller		microprocessor PID with external 7" full colour touch screen			
interior		acid-proof stainless steel to DIN 1.4301			
housing	-	powder coated sheet			
	IG	stainless steel linen finish			
overall dims ¹ [mm]	A width	670	830	1030	1270
	B height	1340	1600	1850	2010
	C ² depth	820	880	880	990
internal dims [mm]	D width	460	600	800	1040
	E height	530	800	1040	1200
	F depth	440	500	500	600
max shelf workload ³ [kg]	-	10	10	10	-
	PW ³ version	50	100	100	100
max unit workload [kg]		60	90	120	140
nominal power [W]		2900	3250	3650	4250
weight [kg]		122	140	185	275
temperature fluctuation* at +25°C and 60%rH [±/°C]		2,0	2,0	2,0	2,0
temperature variation* at +25°C and 60%rH [±/ %rH]		5,0	5,0	5,0	5,0
temperature protection		class 3.3 to DIN 12880			
power supply**		230V 50-60Hz		400V 50-60Hz	
shelves fitted/max		2/7	3/10	3/14	5/16
refrigerant		R1234ze / GWP=1		R290 / GWP=3	
warranty		24 months			
manufacturer		POL-EKO-APARATURA			

all the above technical data refer to standard units (without optional accessories)

* - fluctuation measured in centre of chamber; in space, variation (K) calculated for chamber as: $K = \pm (T_{avg\ max} - T_{avg\ min}) / 2$

** - other power supplies on request

1 - external dimensions for units without FIT option, depth doesn't include 50 mm of power cable

2 - on uniformly loaded surface

3 - reinforced shelf

Reverse osmosis system included, external dimensions of the unit do not include the reverse osmosis system (14 kg).

OPTIONS AND ACCESSORIES (icon description see page 76-82)

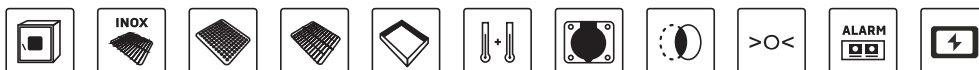

■ Dimensions KK/KKS 115/240/400/750

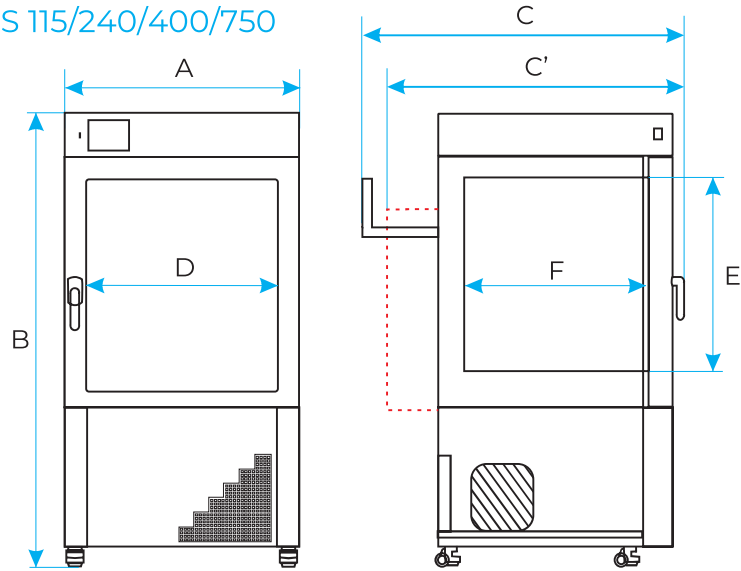

■ Dimensions KK 350

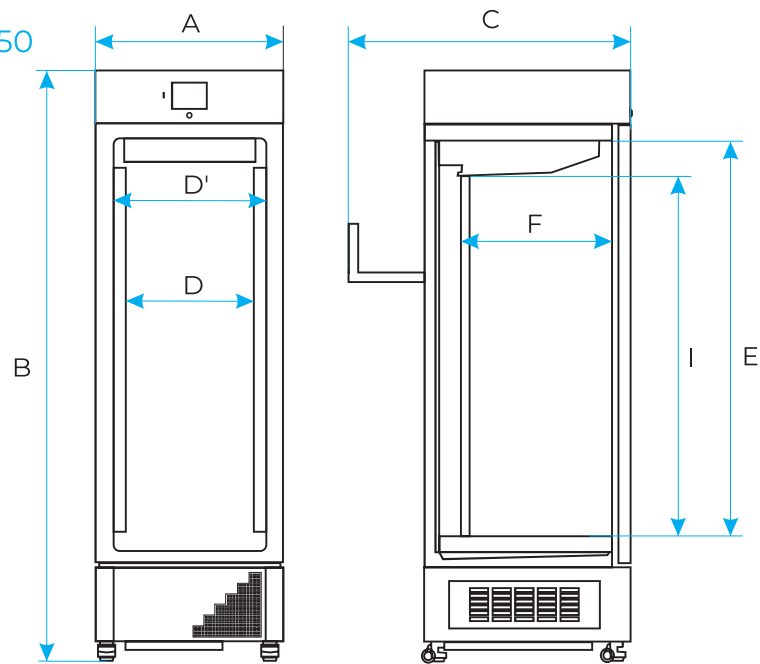

■ Dimensions KK 500/700/1200/1450

