



# Leica DME

## Compound Microscope System

### **The Vision to Create Microscopy Solutions for Education.**

When designing the DME for the educational setting, the main priorities were to maximize performance and maintain a competitive price. By using high quality components, engineering expertise, and advanced design, Leica drew upon 150 years of experience to create an instrument that would truly take educational microscopy into the next generation.

### **The vision to create a student-friendly instrument.**

For general biology and specific life science laboratory sessions in the university setting, the DME incorporates superb optics and illumination with user-friendly components for easy use. Features like the rear-facing, parfocal nosepiece gives students easy access to the specimen and prevents students from bumping objectives. Components like the eyepiece and binocular body have been designed for maximum comfort and minimum adjustment. The tamper-proof design and compact size make set-up, storage and maintenance effortless. These features combine to form a microscope ideal for specimen examination in general pathology, histology, microbiology, botany, zoology and other life science courses.

### **The vision to maximize performance.**

For highly demanding educational environments like medical, dental and veterinary schools, the DME provides an outstanding solution to your students' dynamic applications. With its state-of-the-art illumination system and advanced optics, students can perform a range of techniques including bright-field, darkfield, polarization, phase contrast and photomicrography easily and efficiently. Infinity optics provide high contrast imaging quality and complete optical compatibility with higher performance Leica microscopes, with the option to add accessories without affecting the microscope's magnification. For high performance in highly demanding environments, the DME is your microscopy solution.

### **Great discoveries begin with vision.**



### **Louis Pasteur** 1822–1895

A visionary whose foremost discovery is the germ theory of disease, Pasteur's work became the foundation for the science of microbiology and a cornerstone of modern medicine. His discoveries include the use of immunizations to prevent disease.

**Leica**

MICROSYSTEMS

# Leica DM E SYSTEM DIAGRAM

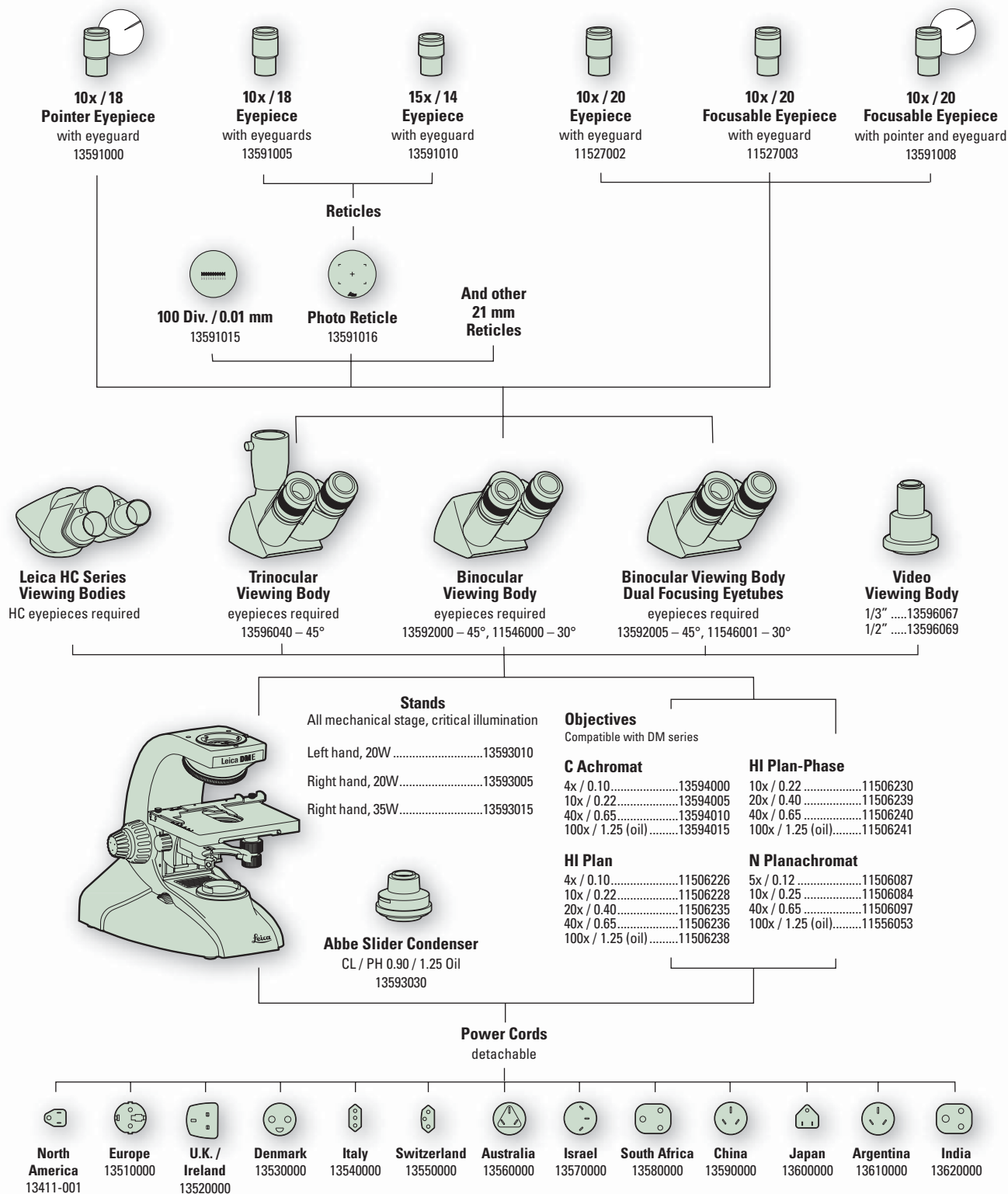

## PRECONFIGURED SYSTEMS (other configurations available)

### Achromat Systems

Binocular Viewing Body...13595000  
Trinocular Viewing Body...13595000T

- Critical illumination stand
- Right hand mechanical stage
- 10x/18 eyepieces (one with pointer)
- Eyeguards
- Abbe slider condenser
- 4x, 10x, 40x and 100x oil C Achromat objectives
- Specified power cord
- Immersion oil
- Spare lamp 12V, 20W

### Planachromat Systems

Binocular Viewing Body...13595001  
Trinocular Viewing Body...13595001T

- Critical illumination stand
- Right hand mechanical stage
- 10x/18 eyepieces (one with pointer)
- Eyeguards
- Abbe slider condenser
- 4x, 10x, 40x and 100x oil C Planachromat objectives
- Specified power cord
- Immersion oil
- Spare lamp 12V, 20W

### Phase Systems

Binocular Viewing Body...13595002  
Trinocular Viewing Body...13595002T

- Critical illumination stand
- Right hand mechanical stage
- 10x/18 eyepieces (one with pointer)
- Eyeguards
- Abbe slider condenser
- 10x, 20x, 40x and 100x oil phase contrast objectives
- Green filter
- 4-Position phase slider, BF, 10x / 20x, 40x, 100x
- Specified power cord
- Immersion oil
- Spare lamp 12V, 20W

## DOCUMENTATION ACCESSORIES

### BASIC PHOTOGRAPHY

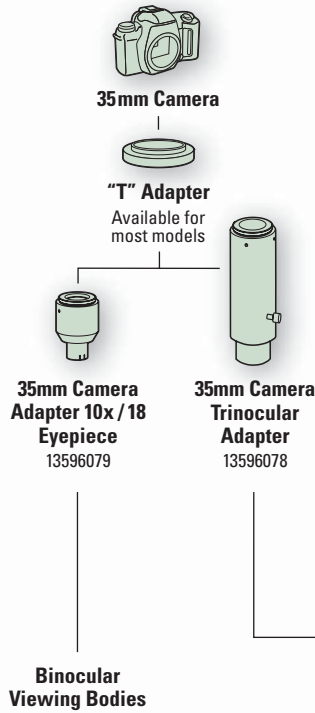

### ADVANCED PHOTOGRAPHY

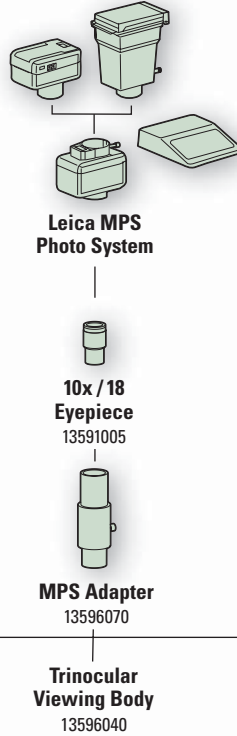

### ELECTRONIC IMAGING

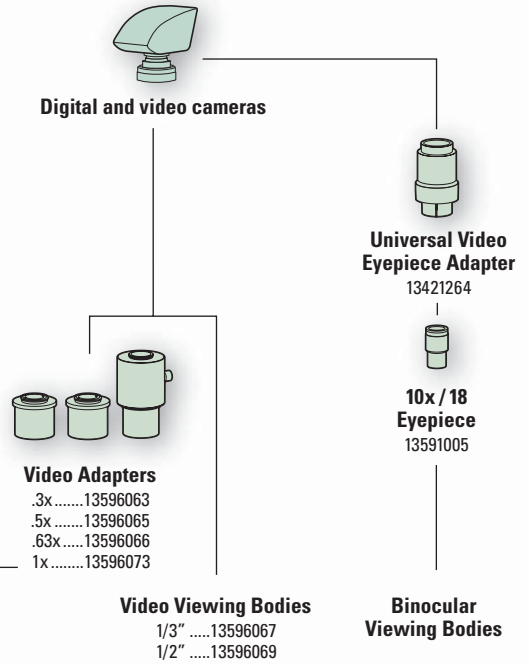

## ILLUMINATION / CONTRAST TECHNIQUES ACCESSORIES

### POLARIZATION



### KOEHLER



### DARKFIELD

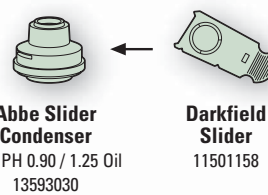

### FILTERS

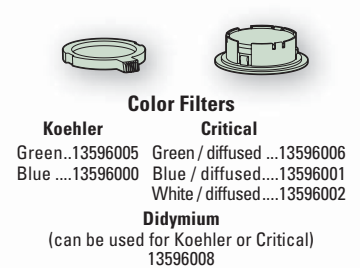

### PHASE CONTRAST

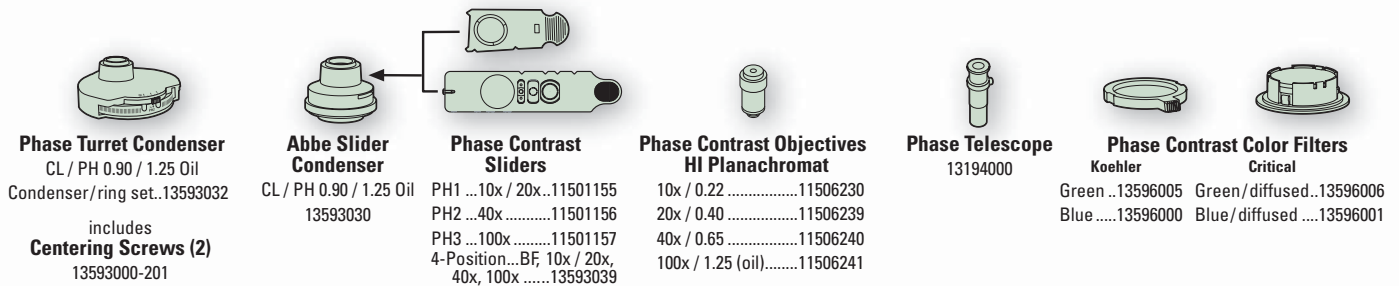

## OTHER ACCESSORIES

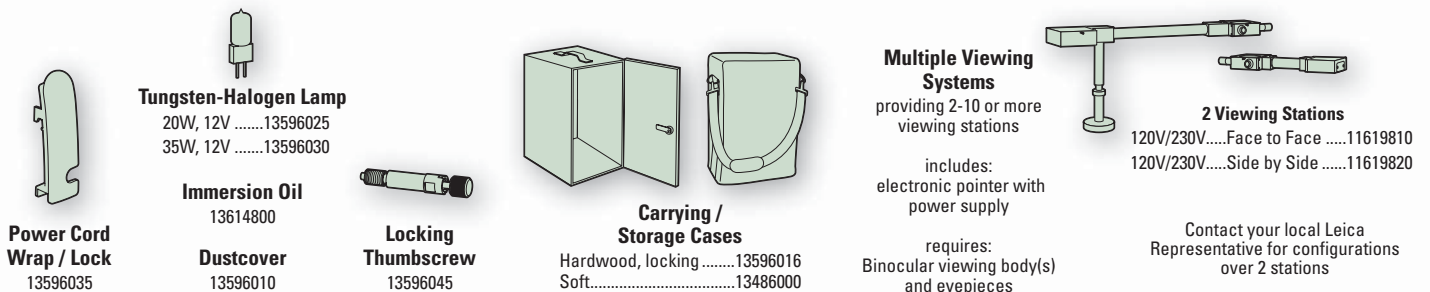

# Leica DME Specifications

## VIEWING BODIES

- Binocular**
- Siedentopf style
  - 30° or 45° viewing angle
  - 50mm to 75mm IPD range
  - 360° rotation
- Trinocular**
- Siedentopf style
  - 30° viewing angle
  - 50mm to 75mm IPD range
  - 360° rotation
  - 50/50 coating light split
- Video**
- .3x, .5x, .63x or 1x
- Other**
- Mirrors and prisms, coated glass parts
  - Standard Allen screw (3mm) or optional spring-loaded thumbscrew for locking in place

## EYEPIECES

- Style**
- Periplan
  - 10x, 18mm FOV
  - 10x, 20mm FOV with pointer
  - 15x, 14mm FOV
- Rubber Eyeguards**
- Standard with 10x eyepieces
  - 34.2mm diameter, 10mm height
  - 1.35" diameter, 0.4" height
  - Eyeguard folds over eyepiece
- Reticules**
- 21 mm diameter
  - Use with 10x eyepiece without pointer
  - Simple installation procedure available with purchase of reticules
  - Refer to catalog for part number and description

## OBJECTIVES

- Infinity corrected
- Thread size M25, compatible with DM series
- Achromatic set includes black tamper resistant objective sleeves
- DIN color coded and marked

C Achromat Magnification	Numeric Aperture	Working Distance	Cover Glass
4x	0.10	26.20mm	-
10x	0.22	7.80mm	-
40x	0.65	0.31 mm	0.17
100x oil	1.25	0.10 mm	0.17

## STAND

- Cast aluminum
- Dimensions\***
- 40.8cm (h) x 21.8cm (w) x 37.7cm (d)
  - 16.06" (h) x 8.58" (w) x 14.84" (d)
- Weight\***
- 6.35kg, 14lbs.
- Shipping\* Dimensions**
- 43.5cm (h) x 63.8cm (w) x 34cm (d)
  - 17.125" (h) x 25.125" (w) x 13.375" (d)
- Shipping\* Weight**
- 9.3kg, 20.5lbs.
- Nose Piece**
- Quadruple rear facing with positive stops
  - Rubber grip on turret
- Illumination**
- Critical or Koehler
  - 20w lamp-12v standard, 35w lamp -12v optional
  - 2,000 hours for either 20w or 35w lamps
- Electrical**
- UL, cUL, VDE and CE markings and EMC framework compliant
  - 85-265 VAC, 50/60 Hz

\* with binocular viewing body

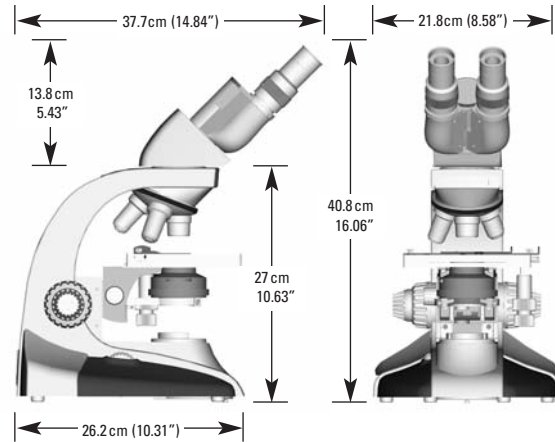

## Stages

- Mechanical left or right handed
- Size: 15cm (X) x 13.6cm (Y) 5.905" (X) x 5.342" (Y)
- Control shaft length 6.1cm, 2.4"
- Travel: 7.6cm (X) x 4cm (Y) 3" (X) x 1.58" (Y)
- Front loading specimen holder for one standard slide

## Sub Stage Assemblies

- Rack and pinion with ball bearings

## Condensers

- Standard slider condenser
- 0.90 / 1.25 oil
- Minimum aperture: 1.3 ± 0.2mm
- Maximum aperture: 30mm
- Accepts phase contrast and darkfield sliders
- Phase turret condenser
- 0.90 / 1.25 oil
- Minimum aperture: 1.3 ± 0.2mm
- Maximum aperture: 25mm

## Filters

- Critical illumination: blue, green, white diffused
- Koehler illumination: blue, green undiffused

## Focusing Mechanism

- Maintenance free for consistent tension
- Coaxial coarse and fine focus knobs with markings on fine focus knobs for each side
- 100 divisions of 3 microns each
- One full fine focus turn equals 300 microns
- One full coarse focus turn equals 2.8 mm

## Miscellaneous

- Dust cover with each complete model
- Multilingual instruction manual with each complete model
- Spare lamp with each complete model (Read instruction prior to replacing lamp)
- Immersion oil with each complete model
- Recommended cleaning solution is methanol or soap and water