

Service Manual

FILE No.

Ultra-Low Temperature Freezer MDF-U53V MDF-U53VC

SANYO Electric Co., Ltd.
Biomedical Business Unit



! RoHS

This product does not contain any hazardous substances prohibited by the RoHS Directive.
(You will find 'RSF' mark near the rating plate on the RoHS compliant product.)

! WARNING

- * You are requested to use RoHS compliant parts for maintenance or repair.
- * You are requested to use lead-free solder.

Effective models

Following units are effective in this manual.

| Model name | Product code | Voltage and Frequency |
|------------|--------------|-----------------------|
| MDF-U53V | 823 190 51 | 220V 50Hz |
| | 823 190 52 | 220V 60Hz |
| | 823 190 53 | 220V 60Hz |
| | 823 190 54 | 230/240V 50Hz |
| | 823 190 55 | 220V 50Hz |
| | | |
| MDF-U53VC | 823 190 80 | 220V 60Hz |
| | | |

Contents

| | Page |
|--|------|
| Comparison MDF-U53V with MDF-U52V ----- | 1 |
| Specifications ----- | 2 |
| * Structural specifications | |
| * Control specifications | |
| * Performance specifications | |
| Dimensions ----- | 5 |
| Refrigeration circuit ----- | 6 |
| Refrigeration circuit welding points ----- | 7 |
| Cooling unit parts ----- | 8 |
| Components on PCB ----- | 9 |
| Electrical parts ----- | 10 |
| Specifications of sensor ----- | 11 |
| Connections on PCB ----- | 12 |
| Wiring diagram ----- | 13 |
| Circuit diagram ----- | 15 |
| Control specifications ----- | 16 |
| Parts layout ----- | 25 |
| Test data ----- | 27 |
| * Pull-down data | |
| * Pull-up data | |
| * H/L EVA out data | |
| * Unit pressure data | |
| * Power consumption data | |
| * Temperature uniformity | |
| * Sample load test | |
| Instruction Manual ----- | 32 |

Comparison MDF-U53V with MDF-U52V

| Item | MDF-U52V | MDF-U53V | Remarks |
|------------------------------|--|--|---|
| Compressor | Sanyo | Toshiba career | Toshiba compressor has been cooperated development. |
| H stage side | 1100W | 1100W | |
| L stage side | 1100W | 1100W | |
| Filter alarm | FILTER lamp is lit | FILTER lamp is lit and buzzer sounds intermittently | |
| Notification of parts change | 2.8yrs, battery accumulating time (BATTERY lamp is lit) | 2.8yrs, battery accumulating time (BATTERY lamp is lit) | Input code '409' in F06 to turn BATTERY lamp off. You can see accumulation time in F03. |
| | Fan motor accumulation time, none | 5.6yrs, fan motor accumulating time (BATTERY lamp is blinking) | Input code '419' in F06 to stop BATTERY lamp blinking. You can see accumulation time in F32. |
| Compressor protection | Overload relay | Overload relay | |
| | <ul style="list-style-type: none"> •H stage side compressor is ceased when it detects 70C higher than filter sensor temperature. •E10 and PV are displayed alternately. (Buzzer sounds and remote alarm terminal turns over) | <ul style="list-style-type: none"> •H stage side compressor is ceased when it detects 60C higher than filter sensor temperature. •E10 and PV are displayed alternately. (Buzzer sounds and remote alarm terminal turns over) | When it detects 10C lower than AT sensor temperature, H stage side compressor turns on. |
| Status 3 | Adding test value, SV and AT makes the compared value. | Compared value = 95% (fixed) | |

Specifications

■Structural specifications

| Item | MDF-U53V | MDF-U53VC |
|-----------------------|---|-----------|
| Name | Ultra-low Temperature Freezer | |
| External dimensions | W770 × D875 × H1990 (mm) | |
| Internal dimensions | W630 × D600 × H1400 (mm) | |
| Effective capacity | 519 L | |
| Outer door | 1door, painted steel | |
| Inner door | 2doors, ABS resin panel with stainless frame | |
| Insulation | Vacuum insulation panel + rigid polyurethane foamed-in place | |
| Exterior | Painted steel | |
| Interior | Painted steel | |
| Shelf | 3shelves, stainless steel Inner dimensions; W608 x D533 (mm) Load; 50kg/shelf | |
| Outer door latch | 1pc | |
| Outer door lock | 1pc | |
| Caster | 4pcs (leveling leg : 2pcs) | |
| Monitoring hole | 3places inner diameter; φ17mm | |
| Refrigeration circuit | Secondary cooling system | |
| Compressor | High stage side; Hermetic type, Output; 1100W Low stage side; Hermetic type, Output; 1100W | |
| Evaporator | High stage side; Cascade condenser Low stage side; Tube on sheet (Sharing with interior) | |
| Condenser | High stage side; Fin and Tube type Low stage side; Cascade condenser | |
| Refrigerant | High stage side; R-407D (HFC refrigerant) Low stage side; R-508 (HFC refrigerant) | |
| Refrigerant oil | Ze-NIUS32SA | |
| Power supply | Local voltage | |
| Weight | 305 Kg | 310 Kg |
| Accessories | 1 set of key, 1 scraper | |
| Optional component | Automatic temperature recorder(MTR-G85) Back-up system (CVK-UB2, CVK-UB2(I)); LCO2 Inventory rack (IR-220, IR-224U) Independent inner door (MDF-5ID) | |

■Control specifications

| Item | | MDF-U53V | MDF-U53VC |
|------------------------|-----------------|---|-----------|
| Temp. controller | | Microcomputer control system Temperature setting range: -50°C~-90°C Non-volatile memory | |
| Thermal sensor | | Pt.1000Ω | |
| Temperature display | | Digital display | |
| Alarm | Temperature | +5°C~+20°C for High temperature alarm (Initial; +10°C) -5°C~-20°C for Low temperature alarm (Initial; -10°C) ALARM lamp blinks and buzzer sounds intermittently with 15min. delay Remote alarm contact; Normal Open, Normal Close Allowable contact capacity; 30VDC, 2A | |
| | Door | DOOR lamp is lit with 2min. delay | |
| | Filter check | FILTER lamp is lit and buzzer sounds intermittently | |
| | Power failure | ALARM lamp blinks, buzzer sounds intermittently and remote alarm is output. | |
| | Remote alarm | Remote alarm terminal 3P; DC30V, 2A NC-COM, NO-COM | |
| | Battery check | When approx. 2.8yrs has passed with power switch is on, BATTERY lamp is lit. | |
| | Fan motor check | When approx. 5.5yrs has passed with power switch ON, BATTERY lamp is flashed. | |
| Freezer status monitor | | <ul style="list-style-type: none"> Abnormal low voltage (When the power source voltage is 15% less than the rated voltage) Abnormal ambient temperature (When the ambient temperature is over 35°C or lower than 0°C) Overloaded run (When the running rate of compressor (L) is over 90%) | |
| Control panel | | Lamps: ALARM, BATTERY, STATUS, DOOR, FILTER Buzzer key: BUZZER Alarm test key: ALARM TEST Status key: STATUS Set key: SET Digit shift key: ▶▶ Numerical value shift key: ▲ | |
| Key lock function | | Press ▶▶key for 5 seconds to display; L0: Key lock is off L1: Key lock is on | |
| Sensor abnormality | | When any failure is occurred in sensor among temp. sensor, filter sensor, cascade sensor and AT sensor; <ul style="list-style-type: none"> Error code is displayed ALARM lamp blinks Remote alarm is on Buzzer sounds intermittently | |
| Compressor protection | | When the cascade sensor temperature is lower than -34°C, Compressor L is turned on. When the cascade sensor temperature is higher than -12°C, Compressor L is turned off. When the overload relay and/or filter sensor is higher than +60°C, Compressor H is turned off. | |
| Compressor delay time | | You can change the delay time both of Compressor L & H as; 2~15min. | |

■ Performance specifications

| | | | | |
|---------------------------|--|------------|------------|------------|
| Cooling performance | -86°C at the center of the chamber (AT30°C, no load) | | | |
| Temperature control range | -50°C~-86°C(AT30°C, no load) | | | |
| Power source | 220V, 50Hz | 220V, 60Hz | 230V, 50Hz | 240V, 50Hz |
| Rated power consumption | 1020W | 1180W | 1070W | 1150W |
| Noise level | 49 dB {A} (background noise 20dB) | | | |
| Maximum pressure | 2600 kPa | | | |
| Usable conditions | AT; +5°C~+30°C Humidity: Less than 80%RH | | | |

* Design or specifications will be subject to change without notice.

Dimensions

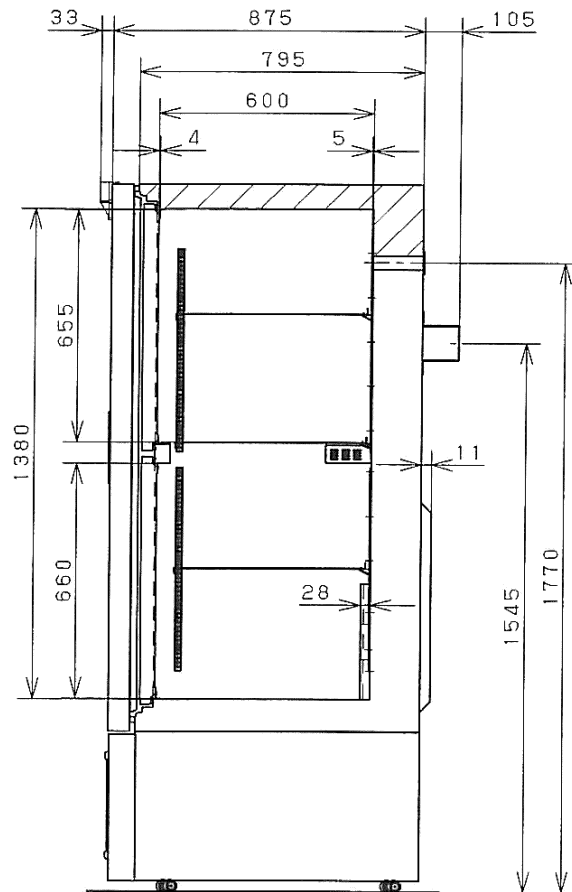
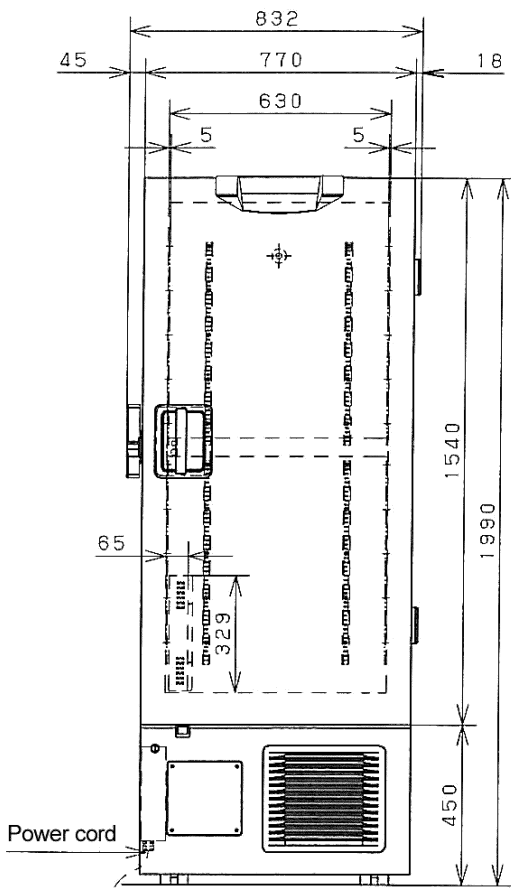
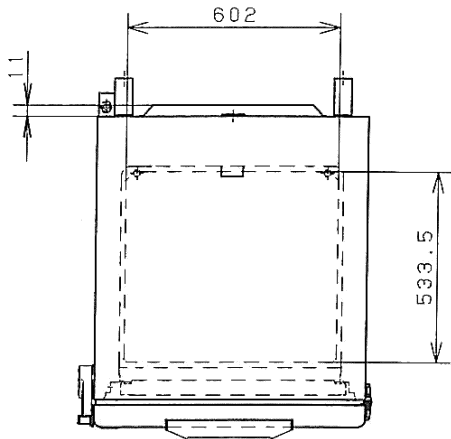

Refrigeration circuit

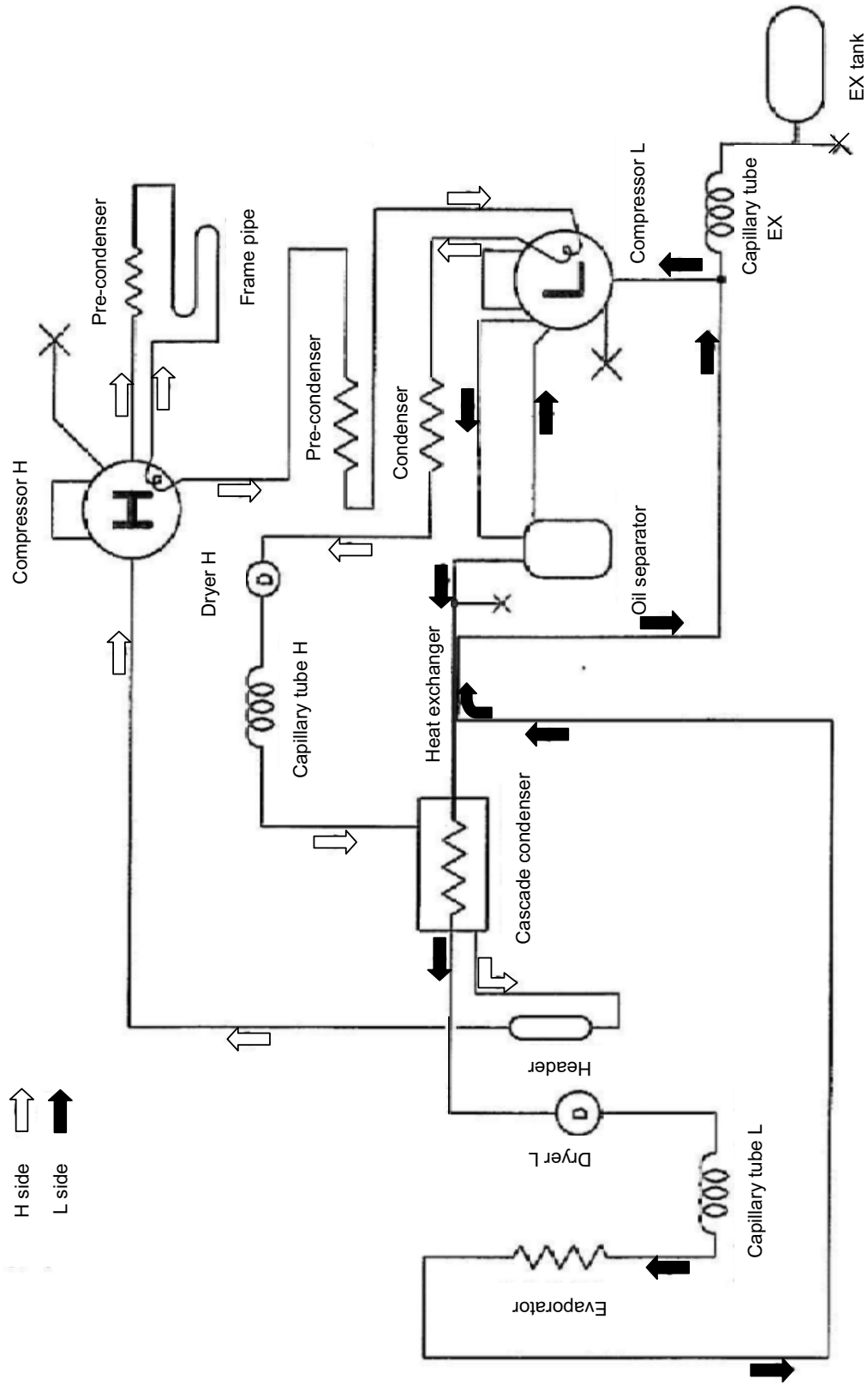

↑ H side
 → L side

Cooling unit parts

<MDF-U53V/U53VC>

| Item | Specifications | | |
|--|---|---|--|
| | H side | | L side |
| Compressor | 220V, 60Hz | 220V, 50Hz | 230/240V, 50Hz |
| Code | 7FB-0-M101-001-06 | 7FB-0-M101-001-04 | 7FB-0-M101-001-05 |
| Type | KS370J1NS-7A | KS370J1NS-4A | KS370J1NS-4A1 |
| Refrigerant oil | Ze-NIUS32SA Charged q'ty: 850cc | | Ze-NIUS32SA Charged q'ty: 850cc |
| Cooling system | Forced air cooling (partially) Oil cooler | | Forced air cooling (partially) Oil cooler |
| Condenser | | | |
| Type | Fin and tube | | Cascade condenser |
| Condenser | 12 columns x 4 lines P6.35mm Fin 88pcs. | | Coil pipe ϕ 6.35mm |
| Pre-condenser | W 250mm | | — |
| Frame pipe | ϕ 4.76mm | | — |
| Evaporator | Cascade condenser Shell and tube ϕ 80mm | | Tube on sheet ϕ 9.52mm |
| Capillary tube | | | Ex. capillary |
| Resistance PSI · kg/cm ² | 94 PSI/G | 98 PSI/G | 34 PSI/G |
| Length | 1800mm | 1200mm | 500mm |
| Outer diameter | ϕ 2.0mm | ϕ 2.0mm | ϕ 2.4mm |
| Inner diameter | ϕ 1.0mm | (ϕ 0.9mm) | ϕ 1.2mm |
| Refrigerant | R-407D Charged q'ty: 564g | R-508 Charged q'ty: 260g | |
| Oil additive | n-Pentane Charged q'ty: 60cc (36g) | n-Pentane Charged q'ty: 58cc (36.8g) | |
| Dryer | 4A-XH-9 Charged q'ty: 18g | 4A-XH-6 Charged q'ty: 58g | |
| Condensing fan | ϕ 230 mm, 4 blades Material: ABS | | |
| Condensing fan motor | SE4-E11L3P (high stage side) | | |
| Oil separator | — | | SPK-0S02S2 (810-4-2008) |

<Compressor terminals layout>

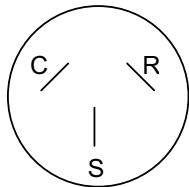

Components on PCB

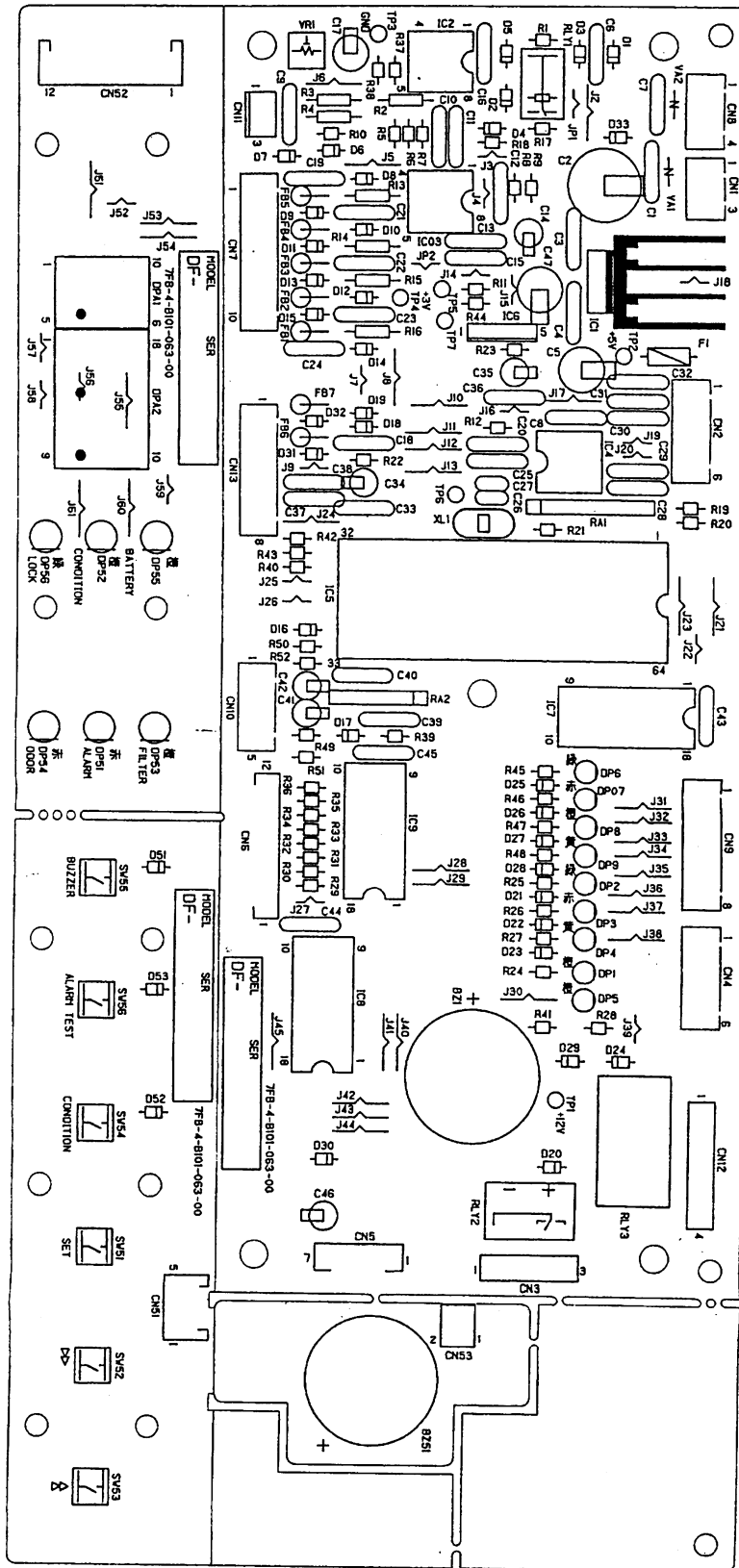

Electrical Parts

| MDF-U53V/U53VC | | 220VAC, 60Hz | 220VAC, 50Hz | 230/240VAC, 50Hz |
|------------------------------------|--------------------------------|------------------------|------------------------|------------------------|
| Compressor (H),(L) | Type | KS370J1NS-7A | KS370J1NS-4A | KS370J1NS-4AI |
| | Code | 7FB-0-M101-001-06 | 7FB-0-M101-001-04 | 7FB-0-M101-001-05 |
| | Rated voltage (50/60Hz) | 220V, 60Hz | 220/230V, 50Hz | 230/240V, 50Hz |
| | Winding resistance C-S(Aux) | 1.64 Ω | 2.53 Ω | 2.53 Ω |
| | C-R(Main) | 3.35 Ω | 4.8 Ω | 4.8 Ω |
| Starting relay(H), (L) | Type | AMVL-300A | AMVL-300A | AMVL-300A |
| | Pick up voltage | 215~247VAC(60Hz) | 185~217VAC(50Hz) | 185~217VAC(50Hz) |
| | Drop out voltage | 69~132VAC(60Hz) | 60~120VAC(50Hz) | 60~120VAC(50Hz) |
| | Parts code | 626 100 1503 | 626 100 1503 | 626 100 1503 |
| | Overload relay (H), (L) | Type | MRA999549201 | MRA999539201 |
| Action to the temp. (no current) | ON:69±11°C OFF:135±5°C | ON:69±11°C OFF:135±5°C | ON:69±11°C OFF:135±5°C | ON:69±11°C OFF:135±5°C |
| | Action to the current (AT25°C) | 29.5A | 22.5A | 22.5A |
| | Operation time | 6~16sec. | 6~16sec. | 6~16sec. |
| | Parts code | 624 226 3173 | 624 226 3166 | 624 226 3166 |
| Starting capacitor(H),(L) | Rating | 250VAC, 10MF | 250VAC, 10MF | 250VAC, 10MF |
| Running capacitor (H),(L) | Rating | 400VAC, 25MF | 400VAC, 25MF | 400VAC, 25MF |
| Condensing fan motor | Type | SE4-E11L5P | SE4-E11L5P | SE4-E11L5P |
| | Rating | 220-240VAC | 220-240VAC | 220-240VAC |
| | Parts code | 624 224 0167 | 624 224 0167 | 624 224 0167 |
| Cap.tube heater | Rating | 230V, 12W | 230V, 12W | 230V, 12W |
| | Parts code | 624 200 0280 | 624 200 0280 | 624 200 0280 |
| H Comp. relay | Type | G4F-11123T | G4F-11123T | G4F-11123T |
| | Contact capacity | 20A, 250VAC | 20A, 250VAC | 20A, 250VAC |
| | Coil | 12VDC | 12VDC | 12VDC |
| | Parts code | 624 173 2397 | 624 173 2397 | 624 173 2397 |
| Heater relay | Type | G2R-1A-T | G2R-1A-T | G2R-1A-T |
| | Contact capacity | 10A, 250VAC | 10A, 250VAC | 10A, 250VAC |
| | Coil | 12VDC | 12VDC | 12VDC |
| | Parts code | 624 188 9299 | 624 188 9299 | 624 188 9299 |
| Temp. control relay | Type | G4F-11123T | G4F-11123T | G4F-11123T |
| | Contact capacity | 20A, 250VAC | 20A, 250VAC | 20A, 250VAC |
| | Coil | 12VDC | 12VDC | 12VDC |
| | Parts code | 624 173 2397 | 624 173 2397 | 624 173 2397 |
| Switching power supply | Type | LDA10F-12 | LDA10F-12 | LDA10F-12 |
| | Rated output | 12VDC, 0.9A | 12VDC, 0.9A | 12VDC, 0.9A |
| | Parts code | 624 226 2053 | 624 226 2053 | 624 226 2053 |
| Temperature sensor | Type | SS-12-T | SS-12-T | SS-12-T |
| | Rating | 1000 Ω | 1000 Ω | 1000 Ω |
| AT sensor | Type | 502AT | 502AT | 502AT |
| | Rating | 5K Ω, 25°C | 5K Ω, 25°C | 5K Ω, 25°C |
| Filter sensor | Type | 502AT | 502AT | 502AT |
| | Rating | 5K Ω, 25°C | 5K Ω, 25°C | 5K Ω, 25°C |
| Cascade sensor | Type | 502AT | 502AT | 502AT |
| | Rating | 5K Ω, 25°C | 5K Ω, 25°C | 5K Ω, 25°C |
| Door switch | Type | SDKNA20700 | SDKNA20700 | SDKNA20700 |
| | Rating | 5V, 5MA | 5V, 5MA | 5V, 5MA |
| Noise filter | Type | ZAC2220-11 | ZAC2220-11 | ZAC2220-11 |
| | Rating | 250VAC, 20A | 250VAC, 20A | 250VAC, 20A |
| Power cord | Type | GTVD-2,3 | GTVD-2,3 | GTVD-2,3 |
| Battery switch | Type | SLE6A2-5 | SLE6A2-5 | SLE6A2-5 |
| | Rating | 250VAC, 4A | 250VAC, 4A | 250VAC, 4A |
| Battery | Type | 5HR-AAC | 5HR-AAC | 5HR-AAC |
| | Rating | 6V, 1100mAh | 6V, 1100mAh | 6V, 1100mAh |
| | Parts code | 624 209 9284 | 624 209 9284 | 624 209 9284 |
| Handle heater | Rating | 9VAC, 0.83W | 9VAC, 0.83W | 9VAC, 0.83W |
| Transformer | Type | S41-RN97PV | S41-RN97PV | S41-RN97PV |
| | Primary | 115V | 115V | 115V |
| | Secondary | 230V | 230V | 230V |
| | Parts code | 624 226 7645 | 624 226 7645 | 624 226 7645 |
| Breaker switch | Type | BAM215131 | BAM215131 | BAM215131 |
| | Rating | 250V, 15A | 250V, 15A | 250V, 15A |
| Boost relay (MDF-U53VC only) | Type | G7L-1A-TUB | | |
| | Rating | 30A, 220V, DC24V | | |
| Power relay (MDF-U53VC only) | Type | DS1E-M-DC12V | | |
| | Rating | 12V, 0.4A, 125V | | |
| Breaker switch (MDF-U53VC only) | Type | IR11A2E201R | | |
| | Rating | 250VAC, 20A | | |
| Power transformer (MDF-U53VC only) | Type | ATR-HJ61TC-1 | | |
| | Rating | 200, 225, 240V | | |
| Power transformer (MDF-U53VC only) | Type | ATR-D35003 | | |
| | Rating | P:208V, S:230V | | |

* For the compressor specified for China;
Type: KS370J1NS-4A (CCC authorized)

Specifications of sensor

The following shows the temperature in thermal sensor (502AT-1) and its resistance value.

| Temp. (C) | Resistance Value (k Ω) | Temp. (C) | Resistance Value (k Ω) | Temp. (C) | Resistance Value (k Ω) | Temp. (C) | Resistance Value (k Ω) |
|-----------|--------------------------------|-----------|--------------------------------|-----------|--------------------------------|-----------|--------------------------------|
| -50 | 154.5 | -36 | 71.80 | -22 | 35.65 | 0 | 13.29 |
| -49 | 145.9 | -35 | 68.15 | -21 | 33.99 | 5 | 10.80 |
| -48 | 137.8 | -34 | 64.71 | -20 | 32.43 | 10 | 8.84 |
| -47 | 130.2 | -33 | 61.48 | -19 | 30.92 | 15 | 7.20 |
| -46 | 123.1 | -32 | 58.43 | -18 | 29.50 | 20 | 6.01 |
| -45 | 116.5 | -31 | 55.55 | -17 | 28.14 | 25 | 5.00 |
| -44 | 110.2 | -30 | 52.84 | -16 | 26.87 | 30 | 4.17 |
| -43 | 104.4 | -29 | 50.23 | -15 | 25.65 | 35 | 3.50 |
| -42 | 98.87 | -28 | 47.77 | -14 | 24.51 | 40 | 2.96 |
| -41 | 93.70 | -27 | 45.45 | -13 | 23.42 | 45 | 2.51 |
| -40 | 88.85 | -26 | 43.26 | -12 | 22.39 | 50 | 2.13 |
| -39 | 84.18 | -25 | 41.19 | -11 | 21.41 | 55 | 1.82 |
| -38 | 79.80 | -24 | 39.24 | -10 | 20.48 | 60 | 1.56 |
| -37 | 75.67 | -23 | 37.39 | -5 | 16.43 | 65 | 1.35 |

The following shows the temperature in thermal sensor (PT1000 Ω) and its resistance value.

| Temp. (C) | Resistance Value (Ω) | Temp. (C) | Resistance Value (Ω) | Temp. (C) | Resistance Value (Ω) |
|-----------|-------------------------------|-----------|-------------------------------|-----------|-------------------------------|
| -140 | 450.83 | -70 | 729.99 | 0 | 1000.0 |
| -130 | 491.47 | -60 | 769.02 | 10 | 1038.0 |
| -120 | 531.83 | -50 | 807.87 | 20 | 1076.0 |
| -110 | 571.92 | -40 | 846.58 | 30 | 1113.8 |
| -100 | 611.76 | -30 | 885.13 | 40 | 1151.4 |
| -90 | 651.38 | -20 | 923.55 | 50 | 1189.0 |
| -80 | 690.78 | -10 | 961.84 | 60 | 1226.4 |

Connections on PCB

The following shows the connections of connectors on the Temp. controller PCB.

| Connector | Connects to | Usage |
|-----------|--|---|
| CN1 | Switching power supply | To supply the power to PCB. |
| CN2 | Network interface | To connect to MTR-480 (option) |
| CN3 | Remote alarm terminal #1: COM. #2: N.O. #3: N.C. | Remote alarm contact outputs. In normal condition, open for #1-#2 and closed for #1-#3. |
| CN4 | #1-#2 : Temp. control relay #3-#4 : Heater relay | To control internal temperature (12VDC) To supply the power to Cap. tube heater (12VDC) |
| CN5 | #1-#5: Switch PCB #6-#7: Buzzer | To connect to each switch |
| CN6 | Display PCB | To connect to each LED |
| CN7 | #1-#2: Door switch #5-#6: AT sensor #7-#8: Filter sensor #9-#10: Cascade sensor | To control the door switch To detect the ambient temperature To detect the temperature in condenser outlet pipe. To detect the temperature in cascade. |
| CN8 | #1-#2: Battery (#1:6V #2:Battery switch) #3-#4: Transformer | To supply the power during power failure To supply the power to PCB. |
| CN9 | #1-#2: H. Comp. relay | To control compressor H ON/OFF (12VDC) |
| CN10 | Unused | |
| CN11 | #1-#3: Temp. sensor | To detect the internal temperature. |

Wiring Diagram

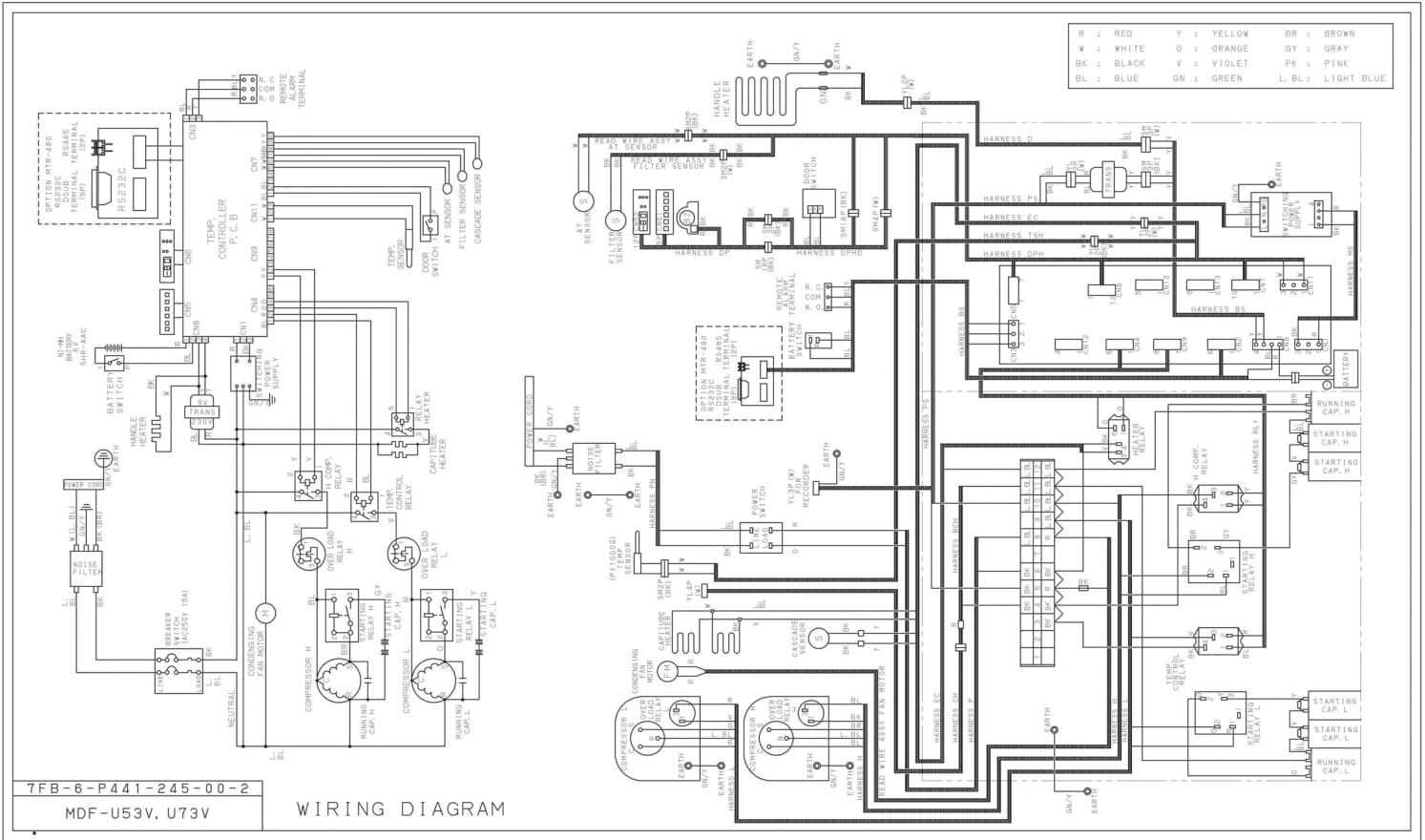

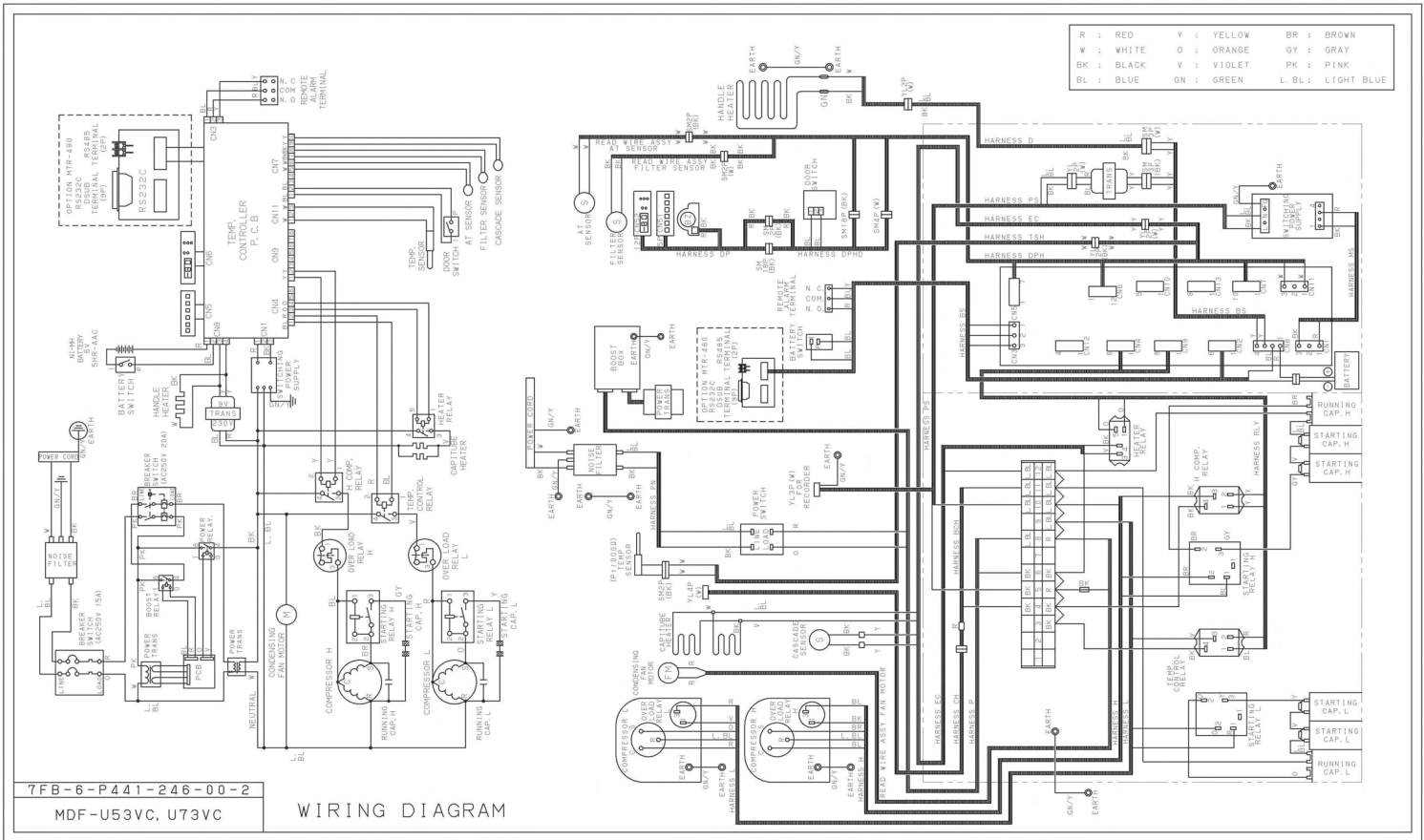

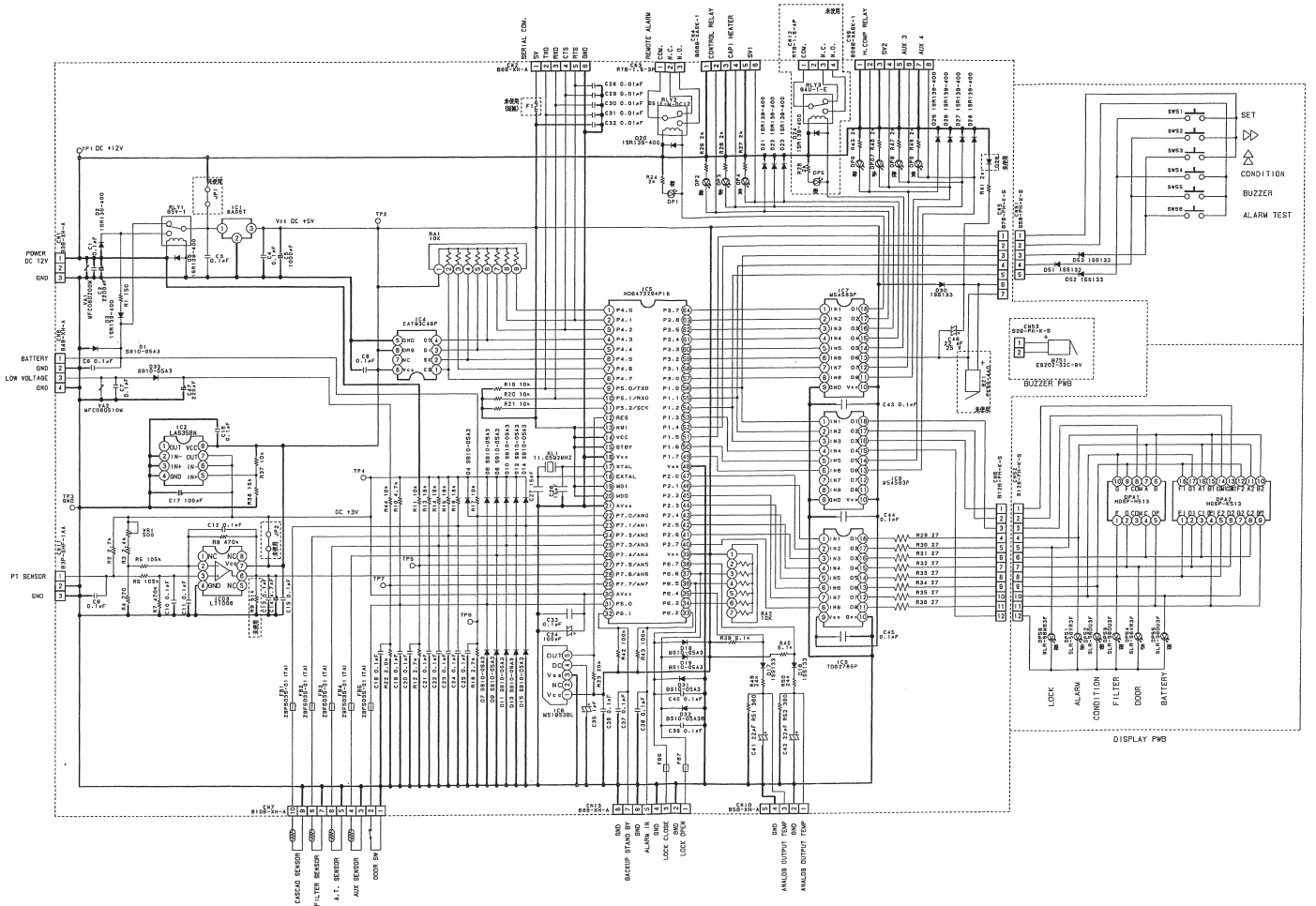

Circuit Diagram





Control specification

1. Key and Switch

- BUZZER** : In alarm condition, buzzer stops sounding with this key pressed. Remote alarm output and alarm message would not be off. During the power failure (battery back-up), press the key to show the present temperature of PT sensor.
- ALARM TEST** : With this key pressed to activate alarm test mode to be forcibly step into alarm condition (ALARM lamp blinks, intermittent buzzer beeps, digital LED goes off and remote alarm inputs). After approx. 90seconds then, normal condition retrieves with Auto Return function. With the battery switch turns off, "E09" blinks on the display.
- SET** : Press this key once to activate set mode (2nd digit in LED blinks), press the key again to store the value to be changed. With Key Lock setting mode ("L 0" or "L 1" is displayed), press the key to store the value to be changed.
- STATUS** : During STATUS lamp is lit, press this key to display status code among '- - 1', '- - 2' and '- - 3'.
-  During setting mode, the blinking digit shifts among the 1st digit or the 2nd digit or 3rd digit.
-  During setting mode, count the blinking digit up. In PV display, press the key over 5 seconds to enter the function mode. ("F00" is displayed)

2. Temperature control



- Setting range** : -50°C~-90°C
- Display range** : -180°C~+50°C
- Setting procedure** : Press SET key and set the required value with  key and  key. Press SET key to store the set value.
- Out of setting range** : If you try to set the value which is out of temperature setting range, it is unacceptable with buzzer beeps for 1second.



3. Temperature alarm

- Setting range** : High temperature alarm ... +5°C~+20°C (Initial setting: 10°C)
Low temperature alarm -5°C~-20°C (initial setting: -10°C)
- Setting procedure** : Keep pressing  key over 5 seconds to enter function mode (F00). Input "F01" for high temperature alarm or "F02" for low temperature alarm. Press SET key to set the value to be changed with the 1st digit blinks. Press SET key again to store the value in the non-volatile memory.
- Out of setting range** : If you try to set the value which is out of alarm setting range, it is unacceptable with buzzer beeps for 1 second.

4. Key Lock mode and Function mode

A) Key Lock mode

- Setting range** : 0, 1
- Setting procedure**: In PV display, keep pressing  key over 5 seconds to enter into Key Lock mode. ("L_0" or "L_1" is displayed. initial: L_0) with "0" or "1" blinks. Change the value with  key and press SET key to store the value in the non-volatile memory.

- B) Function mode
 Setting range : 00~32
 Display range : 00~39
 00, 16 and 33~39 are unavailable.
 Setting procedure : In PV display, keep pressing  key over 5 seconds to enter function mode (F00 is displayed). Change the blinking 1st digit to desired function code with  key and  key. Press SET key to be function code available.
 If you input 00 and 16 then press SET key, automatically revert to PV display.
 Out of setting range : If you try to input F33~F39, it is unacceptable to change with automatically revert to PV display.

5. Warning function

- Door alarm : Leave the outer door open and DP54 (red lamp) is lit. Buzzer beeps intermittently after 1~15 min. (Door alarm setting time) has passed. Initial setting time is 2 min. Buzzer does not activate simultaneously with remote alarm terminal output. Once press BUZZER key to stop buzzer beeping, buzzer does not beep again unless alarming condition get backs.
- High temp. alarm : When PV is reached at SV+SV_H (high temp. alarm SV) +1 or higher, ALARM lamp and LED display blinks, intermittent buzzer beeps with approx. 15 minutes of delay and remote alarm output turns on.
 When PV is reached at SV+ SV_H or lower, ALARM lamp and LED display go off, buzzer stops beeping and remote alarm output turns off.
 If you press BUZZER key, the buzzer stops beeping instead remote alarm output does not turn off.
- Low temp. alarm : When PV is reached at SV-SV_L (low temp. alarm SV) -1 or lower, ALARM lamp and LED display blinks, intermittent buzzer beeps with approx. 15 minutes of delay and remote alarm output turns on.
 When PV is reached at SV- SV_L or lower, ALARM lamp and LED display go off, buzzer stops beeping and remote alarm output turns off.
 If you press BUZZER key, the buzzer stops beeping instead remote alarm output does not turn off.
- Filter blockage : With the filter sensor temperature is reached at 48.0°C or higher, FILTER lamp is lit with buzzer beeps intermittently.
 With the filter sensor temperature is reached at 43.0°C or lower, FILTER lamp goes off and buzzer stops beeping.

6. Other function

- Cascade control : Compressor (L) is allowed to turn on when the cascade sensor temperature is reached at -34.1°C or lower during pull-down.
 Compressor (L) is allowed to turn off when the cascade sensor temperature is reached at -12.0°C or higher during pull-up.
- Auto Return : If there is not any key operation for 90 seconds in each setting mode, Key Lock mode and Function mode, automatically reverts to PV mode.
Note) Auto Return is not worked in F09 and F10.
- Sensor temperature : F12: Temperature of temp. sensor is displayed
 (Ex. -80.2°C → displayed as '80.2')
- F13: Temperature of cascade sensor is displayed.
 (Ex. -34°C → displayed as '-34°C')
- F14: Temperature of filter sensor is displayed.
 (Ex. 67°C → displayed as '067')
- F15: Temperature of AT sensor is displayed.
 (Ex. 30°C → displayed as '030')

| | | |
|--|---|--|
| Battery accumulating time | : | F03: Battery accumulating time is displayed. (Ex. 2years and 6months consumed → displayed as '02.5') The display shows '02.8' to inform the battery exhaustion. Replace with new battery. <Reset of accumulating time> Step into F06. Input '409' and press SET key to turn the display to '00.0' with BATTERY lamp goes off. |
| Condensing fan motor accumulating time | : | F32: Condensing fan motor accumulating time is displayed. (Ex. 5years and 6months consumed → displayed as '05.5') <Reset of accumulating time> Step into F06. Input '419' and press SET key to turn the display to '00.0' with DP55 lamp goes off. Note) <u>Notice of condensing fan motor accumulating time is prior to notice of battery accumulating time.</u> |
| ROM version | : | F30: ROM version is displayed (Ex. Ver. 1.00 → displayed as "1.00") |
| Monitor of status | : | DP52 (orange lamp) is lit in the following status; Status 1; When the ambient temperature is over 35.0C or lower than 0C. Press STATUS key once to display '- - 1'. Status 2; When the power source voltage is less than 2.01 VDC between TP7 and TP3. Press STATUS key once to display '- - 2', Status 3; When running rate of refrigerating circuit is higher than usual. When diagnose value of running rate is 95% or higher, the display shows '- - 3'. |

Display on temperature indicator:



Status code displayed is changed every few seconds if two or three status shown at the same time.

order: ('- - 1' → '- - 2' → '- - 3' → '- - 1')

7. Function mode

| | |
|-------|--|
| F00 | Automatically revert to PV display |
| F01 | SV _H (high temp. alarm SV) setting |
| F02 | SV _L (low temp. alarm SV) setting |
| F03 | Battery accumulating time display |
| F04 | Door alarm delay time setting |
| F05 | Compressor (H)/(L) delay time setting |
| F06 | Service code input (code: 384) |
| F07 * | Temperature Zero Adjustment |
| F08 * | Cascade sensor Zero Adjustment |
| F09 | Factory test mode Unavailable |
| F10 | Factory test mode Unavailable |
| F11 | Factory test mode Unavailable |
| F12 * | Display of temperature of temp. sensor |
| F13 * | Display of temperature of cascade sensor |
| F14 * | Display of temperature of filter sensor |
| F15 * | Display of temperature of AT sensor |
| F16 | Automatically revert to PV display |
| F17 * | Model code setting (Initialization of non-volatile ROM and memory) |
| F18 * | Capillary heater is forcibly turned on/off |
| F19 | Factory test mode Unavailable |
| F20 * | Setting for Diagnose value of running rate Unavailable |
| F21 | Communication ID set |
| F22 | Communication mode set |
| F23 * | Display of power supply voltage |
| F24 | Remote alarm terminal output |
| F25 | Ring-back time set |

- F26 * Display of actual operation rate
- F27 * Display of calculated running rate
- F28 * Display of delay time of permission for measuring running rate (2 hrs timer)
- F29 * Display of delay time of permission for measuring running rate (8 hrs timer)
- F30 * ROM version is displayed
- F31 * Filter alarm
- F32 Display of condensing fan motor accumulating time
- F33~F39 Unused



Setting procedure: In PV display, keep pressing  key over 5seconds to display "F00".
 Input the desired function code with  key and  key.
 Press SET key to be function mode available.
 * ... You should input service code in F06 beforehand.
To cancel service code, input "000" in F06 or turn the power off.



- F00: <Purpose> Simply passing through if entered by mistake.
 <Operation> Press SET key in "F00" displayed to revert to PV display.





- F01: <Purpose> SV_H (high temp. alarm SV) setting
 <Operation> Input F01 and press SET key to display "010" (initial value).
 Set the value in the range "005"~"020" with  key. Press SET key
 to store the value and revert to PV display.

- F02: <Purpose> SV_L (low temp. alarm SV) setting
 <Operation> Input F02 and press SET key to display "-10" (initial value).
 Set the value in the range "-05"~"-20" with  key. Press SET key to
 store the value and revert to PV display.













- F03: <Purpose> Battery accumulating time is displayed
 <Operation> Input F03 and press SET key to display alternately F03 with "00.0"
 (in case battery used for a month or less). Press SET key to revert to
 PV display.



- F04: <Purpose> Door alarm delay time is set
 <Operation> Press SET key in "F04" displayed to display '002' (initial setting).
 Change your desired value among '001'~'015' with  key and
  key and press SET key to store the value and revert to PV
 display.

- F05: <Purpose> Compressor (H) / (L) is turned on with forcibly delayed (by minute
 increment) when the power retrieves from the power failure.
 <Operation> Input "F05" and press SET key to display "002" (initial).
 Change the value in the range "002"~"015" with  key and  key.
 Press SET key to store the value and revert to PV display.

- F06: <Purpose> Dividing F-code for customer used from service
 <Operation> Input F06 and press SET key to display "000" (initial value).
 Set to "384" with  key and  key. Press SET key to store the
 value and revert to PV display.
 <Cancel> Input F06 and press SET key to display "384".
 Change to "000" with  key and  key. Press SET key to store
 the value and revert to PV display.
 Turn the power off then on to revert to "000". (not stored in
 non-volatile memory)
 Note) "384" is storied in non-volatile memory during battery back-up.
 (battery SW is ON)

- F07: <Purpose> To match temperature of temp. sensor with temperature of center at
 the chamber.
 <Operation> Input service code in F06 prior to use this mode.
 Input F07 and press SET key to display "00.0" (initial value).

- Change to the desired value in the range “-4.9”~”04.9” with  key and  key.
Press SET key to store the value and revert to PV display.
- F08: <Purpose> To calibrate temperature of cascade sensor
 <Operation> Input service code in F06 prior to use this mode.
 Input F08 and press SET key to display “00.0” (initial value).
 Change to the desire value in the range “-9.9”~”09.9” with  key and  key.
 Press SET key to store the value and revert to PV display.
- F12: <Purpose> To display the temperature of temp. sensor
 <Operation> Input service code in F06 prior to use this mode.
 Input F12 and press SET key to display alternately F12 and “XX.X”
 (present internal temperature). Press SET key to revert to PV
 display. 3 digits indication. Minus “-“ is not indicated.
 Ex) “-85.5°C” → indicated as “85.5”
- F13: <Purpose> To display the temperature of cascade sensor
 <Operation> Input service code in F06 prior to use this mode.
 Input F13 and press SET key to display alternately F13 and “XX.X”
 (present temperature of cascade sensor). Press SET key to revert to
 PV display.
- F14: <Purpose> To display the temperature of filter sensor
 <Operation> Input service code in F06 prior to use this mode.
 Input F14 and press SET key to display alternately F14 and “XX.X”
 (present temperature of filter sensor). Press SET key to revert to PV
 display.
- F15: <Purpose> To display the temperature of AT sensor
 <Operation> Input service code in F06 prior to use this mode.
 Input F15 and press SET key to display alternately F15 and “XX.X”
 (present temperature of AT sensor). Press SET key to revert to PV
 display.
- F16: <Purpose> Simply passing through if entered by mistake.
 <Operation> Press SET key in “F16” displayed to revert to PV display.
- F17: <Purpose> Non-volatile memory initialization, model code change
 <Operation> Service code should be input in F06 prior to use this mode.
 Input F17 and press SET key to display “001”. Change the value
 with  key and  key. Press SET key to store and revert to PV
 display.
 Model code ‘007’: MDF-U53V/U53VC
- F18: <Purpose> To turn capillary heater forcibly on (or off)
 <Operation> Service code should be input in F06 prior to use this mode.
 Input F18 and Press SET key to display “000” (initial).
 Change to desire value “000” or “001” with  key and  key.
 Press SET key to store the value and revert to PV display.
 000: Capillary heater is turned on to off, or turned off to on
 001: Capillary heater is forcibly turned off
- F21: <Purpose> Serial communication ID setting
 <Operation> Input F21 and press SET key to display “000” (initial).
 Change the value in the range “001”~”255” with  key and  key.
- F22: <Purpose> Serial communication mode setting
 <Operation> input F22 and press SET key to display “000” (initial value)
 Change the value with  key and  key.

- F31: <Purpose> Buzzer setting during filter alarm
 <Operation> Input F31 and press SET key to display "001" (initial).
 Change to the desired value with  key and  key.
 Press SET key to revert to PV display.
 000: Buzzer off
 001: Buzzer on
- F32: <Purpose> To display accumulation time of condensing fan motor
 <Operation> Input F32 and press SET key to display F32 and 'xx.x' (accumulation
 time) alternately. Press SET key to revert to PV display.

8. Differential (The point of compressor ON and OFF)

COMP ON: SV +0.4°C
 COMP OFF: SV -2.2°C (for SV is -90°C~-60°C), SV -0.5 (for SV is -59°C~-50°C)

9. Offset value

- 1) PV+0.5°C is the offset value to adjust the difference between temperature of temp. sensor and the center of internal chamber.
 - 2) PVat + (-3.0C) is the offset value to correct the ambient temperature.
- *Note) PVat = Temperature of AT sensor

10. Remote alarm terminal

| | |
|--------------------------------------|-----------------------------------|
| In normal condition: | Remote alarm contact is N.O. N.C. |
| ↓ | ↓ |
| In alarm condition & power failure : | Remote alarm contact is N.C. N.O. |

11. Cycling of High stage compressor

If the filter sensor is higher than or equal to 60°C, the High stage compressor will be turned off. When the filter sensor is within 10°C of the ambient temperature sensor, the High stage compressor will be allowed to turn back on.

12. Sensor failure

(1) Temp. sensor

- Open circuit: E01 and 50°C are displayed alternately, the buzzer beeps intermittently and remote alarm contact outputs.
 The compressor would be allowed to turn on.
 Press BUZZER key to stop the buzzer beeping.
- Short circuit: E02 and -170°C>PV>-180°C are displayed alternately, the buzzer beeps intermittently and remote alarm contact outputs.
 The compressor would be allowed to turn on.
 Press BUZZER key to stop the buzzer beeping.

(2) Cascade sensor

- Open circuited: E03 and PV are displayed alternately, the buzzer beeps intermittently and remote alarm contact outputs.
 The resistance value would be $\infty \Omega$ and temperature would be -34.1°C or lower. Compressor (L) is not forcibly turned off.
 Press BUZZER key to stop the buzzer beeping.
- Short circuited: E04 and PV are displayed alternately, the buzzer beeps intermittently and remote alarm contact outputs.
 Press BUZZER key to stop the buzzer beeping.
 The resistance value would be 0Ω and temperature would be -12°C or higher that causes to be compressor (L) failure. Compressor (L) is forcibly turned off.

- (3) Filter sensor
 Open circuited: E05 and PV are displayed alternately, the buzzer beeps intermittently and remote alarm contact outputs.
 Press BUZZER key to stop the buzzer beeping.
 Short circuited: E06 and PV are displayed alternately, the buzzer beeps intermittently and remote alarm contact outputs.
 Press BUZZER key to stop the buzzer beeping.
- (4) AT sensor
 Open circuited: E07 and PV are displayed alternately, the buzzer beeps intermittently and remote alarm contact outputs.
 Press BUZZER key to stop the buzzer beeping.
 Short circuited: E08 and PV are displayed alternately, the buzzer beeps intermittently and remote alarm contact outputs.
 Press BUZZER key to stop the buzzer beeping.
- (5) Abnormal condenser temp. E10 and PV are displayed alternately, the buzzer beeps intermittently and remote alarm contact outputs.
 Press BUZZER key to stop the buzzer beeping.
 When E10 is shown on the display, the compressor (H) is forcibly turned off. When E10 is not shown, the compressor (H) is permitted to turn on.
- (6) Error code priority
 No.1: Temp. sensor failure (E01 or E02)
 No.2: Cascade sensor failure (E03 or E04)
 No.3: Filter sensor failure (E05 or E06)
 No.4: AT sensor failure (E07 or E08)
 No.5: Abnormal condenser temperature (E10)
- (7) Standard to judge sensor failure
 PT sensor: 49.9°C or higher with E01 displayed (open circuited)
 -170°C or lower with E02 displayed (short circuited)
 Cascade sensor: -60°C or lower with E03 displayed (open circuited)
 60°C or higher with E04 displayed (short circuited)
 Filter sensor: -60°C or lower with E05 displayed (open circuited)
 130°C or higher with E06 displayed (short circuited)
 AT sensor: -60°C or lower with E07 displayed (open circuited)
 60°C or higher with E08 displayed (short circuited)
 Filter sensor: 60°C or higher with E10 displayed
- 13. Cycle to turn capillary heater on**
 Cycle: Every 18 hours
 Period to turn on: 8 minutes (For factory use, unnecessary to change)
 Capillary heater is permitted to turn on after 9seconds later since compressor L was switched to turn off.
 With the compressor L keeps turning on for 60minutes, the compressor L turns off after 1minute passed then and capillary heater is forcibly turned on.
- 14. When the power is supplied (without battery)**
 Compressor H: Compressor H turns on with 2minutes (initial value) of delay after the power was supplied. Compressor H runs with regardless of PV.
 Compressor L: In PV>SV (when the cascade sensor temperature is -34.1°C or lower), compressor L turns on with 2minutes (initial value) of delay after the power was supplied.
 In PV>SV (when the cascade sensor temperature is -34.0°C or higher), compressor L turns on with 2minutes (initial value) of delay after the power was supplied and cascade temperature is reached at -34.1°C.
- *Note) Delay time of both compressor H and L cannot be set individually.
- Setting data: The setting data initialized in F17 is retrieved in non-volatile memory.

15. Other specifications

(1) Lamp specifications:

<Control PCB>

- DP1: Orange lamp
Goes off: High/low temp. alarm, sensor failure, power failure
Lit : Not in alert condition
- DP2: Green lamp
Goes off: Compressor L turns off. (normal condition)
Lit : Compressor L turns on.
- DP3: Red lamp
Goes off: Capillary heater turns off. (normal condition)
Lit : Capillary heater turns on.
- DP4: Yellow lamp
Goes off: Inoperative
Lit: Inoperative
- DP6: Green lamp
Goes off: Compressor H turns off. (normal condition)
Lit : Compressor H turns on.

<Display PCB>

- DP51: Red lamp
Goes off: Not in alarm condition (normal condition)
Blinks : High/low temp. alarm (without delay), or sensor failure, or power failure
- DP52: Orange lamp
Goes off: Inoperative
Lit : Inoperative
Blinks : In F11 performed
- DP53: Orange lamp
Goes off: Not in filter alarm (normal condition)
Lit : In filter alarm
Blinks : In F11 performed
- DP54: Red lamp
Goes off: Inoperative
Lit : Inoperative
Blinks : In F11 performed
- DP55: Orange lamp
Goes off: Length of battery used is 2.8yrs or less (normal condition)
Fan motor accumulation time is less than 5.6yrs
Lit : Length of battery used is 2.8yrs or over
Blinks : In F11 performed
Fan motor accumulation time is equal or more than 5.6yrs
- DP56: Green lamp
Goes off: Inoperative
Lit : Inoperative
Blinks : In F11 performed

(2) Buzzer specifications:

- High/low temp. alarm: Intermittent tone emitted with delay
- Sensor failure: Intermittent tone emitted when EXX (XX=01~08) displayed
- Power failure: Intermittent tone emitted with DPA1 and DPA2 go off
- Key quick: Short tone emitted if available
- Input out of range: 1second continuous tone emitted
- Filter alarm: Intermittent tone emitted with DP53 lit (in F31:001, initial setting)
- Compressor abnormal warming up : Intermittent tone emitted with E10 displayed

Parts layout



Control panel



Boost BOX (MDF-U53VC only)

Power transformer (MDF-U53VC only)

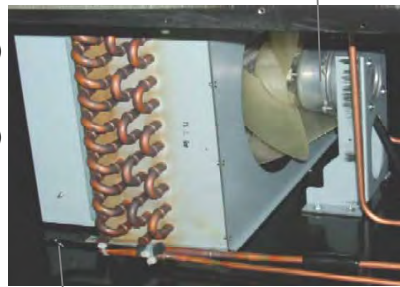

Fan motor

Filter sensor

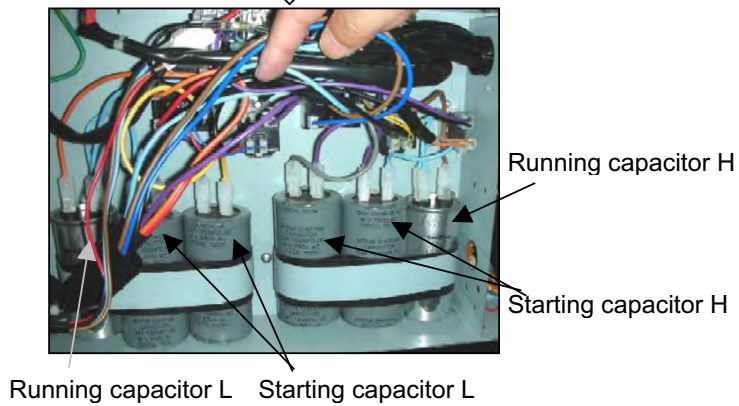
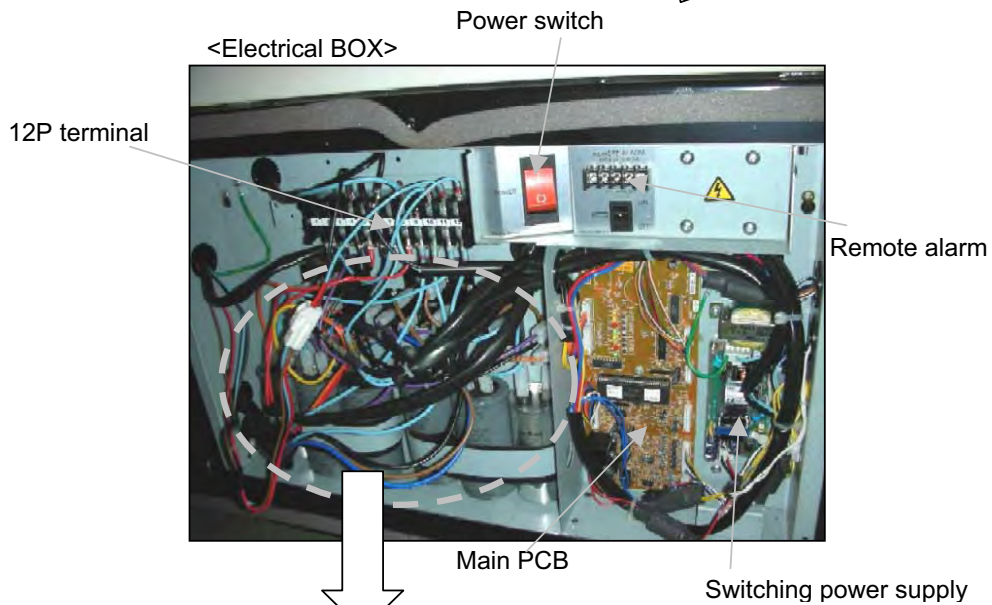
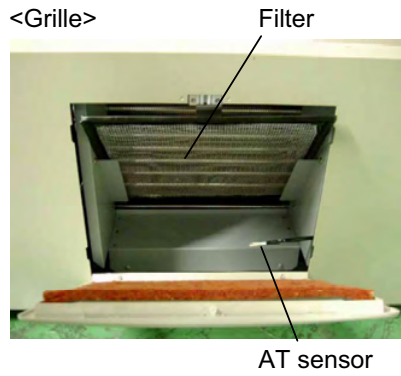

Test data

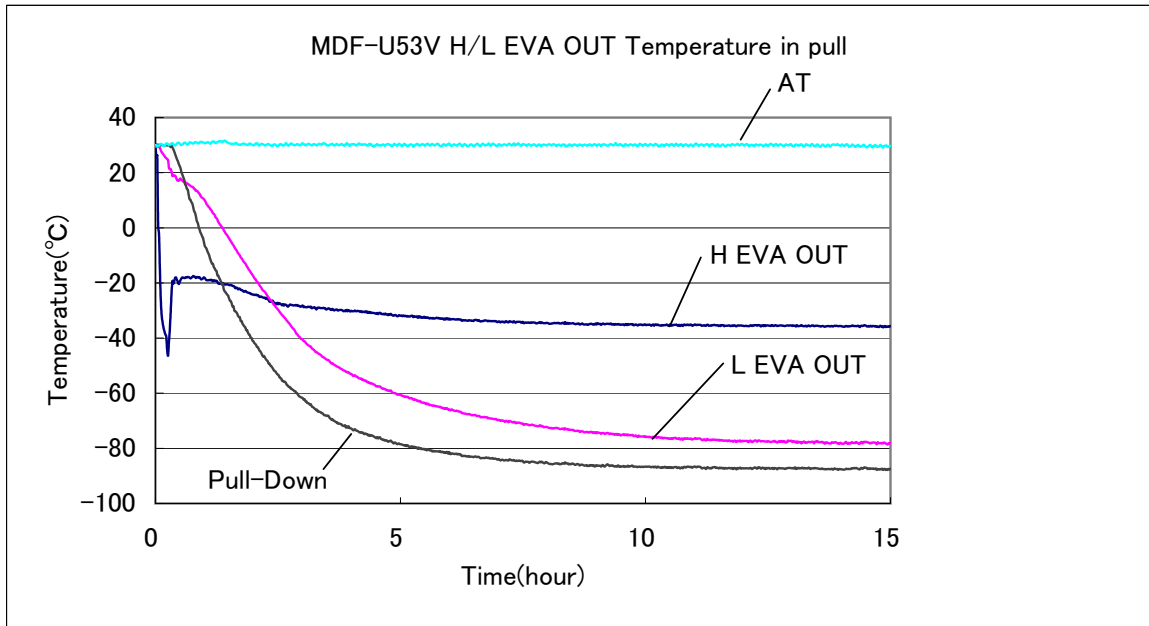
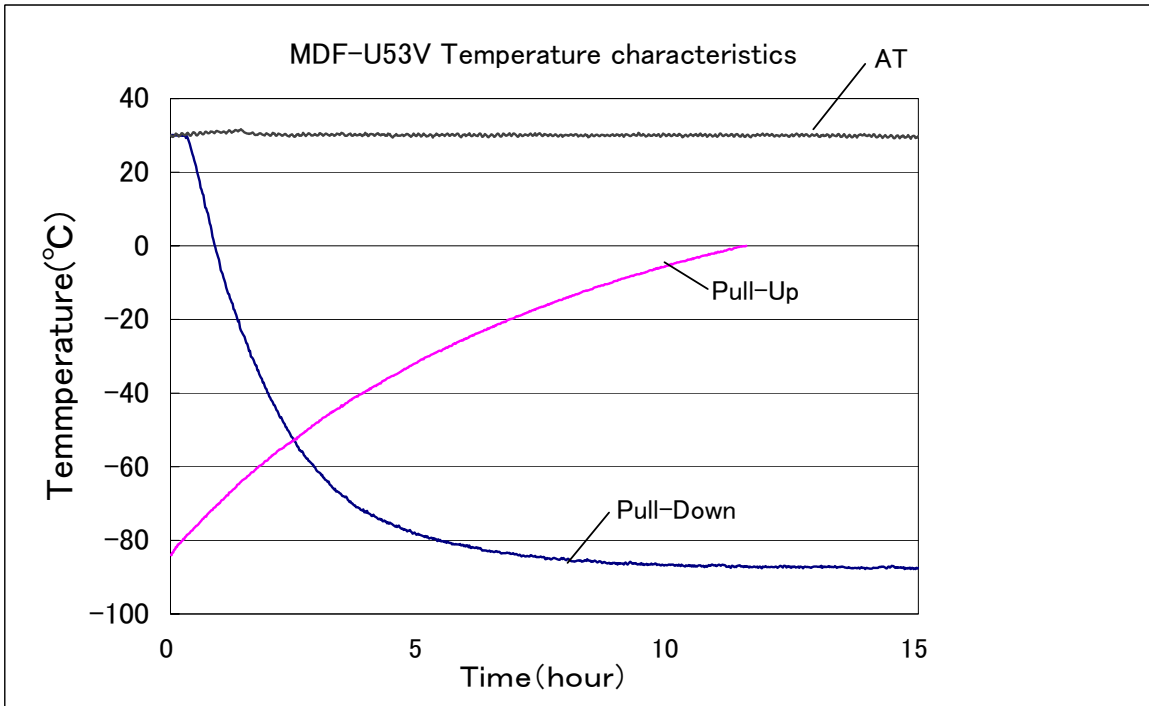

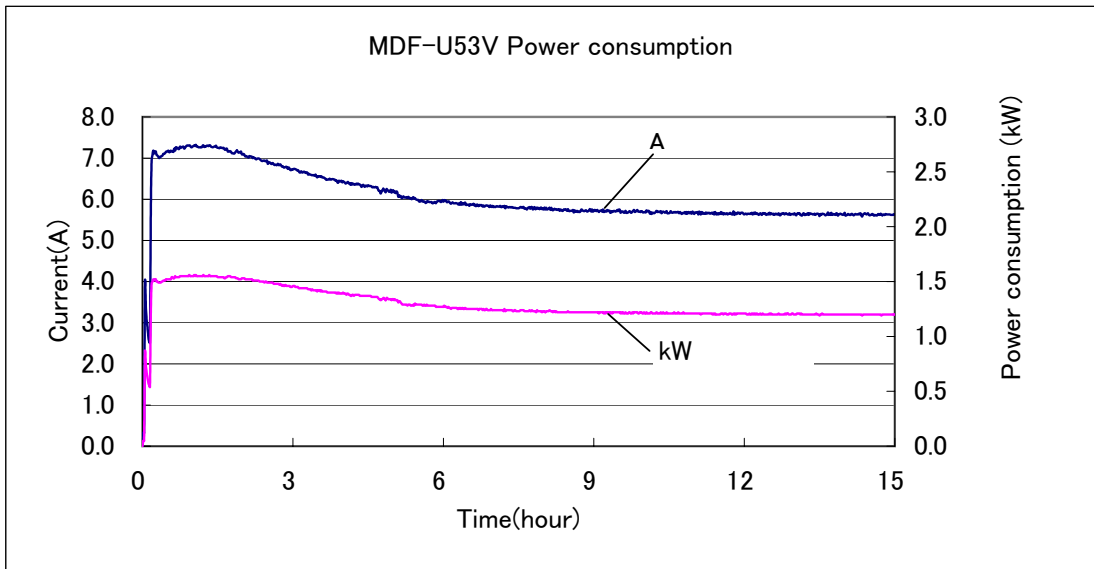
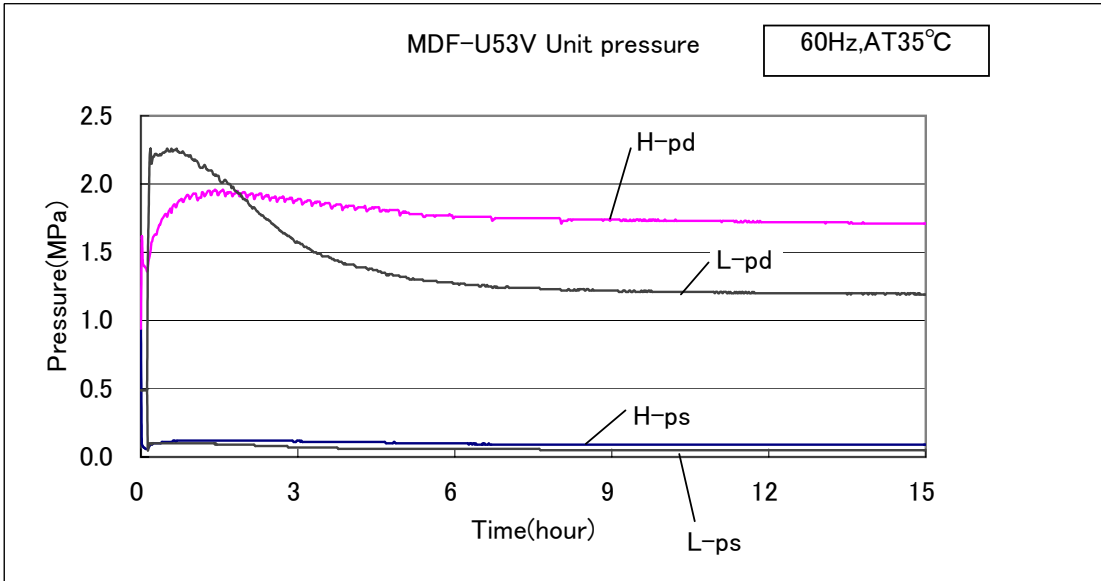

Temperature Uniformity · · · MDF-U53V

~Reference~

Condition: SV-80°C

AT30°C

Load: No load

Measuring point: Center

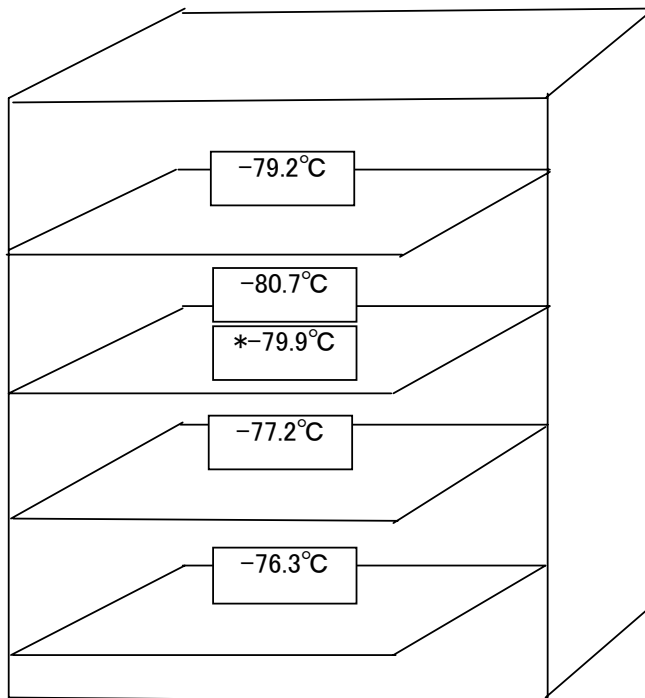

* : 1/2Hair

<Sample load test>

Test conditions: 500ml water x 60 bottles (30L in total)
Measuring point: a, b, c and d as figure shows

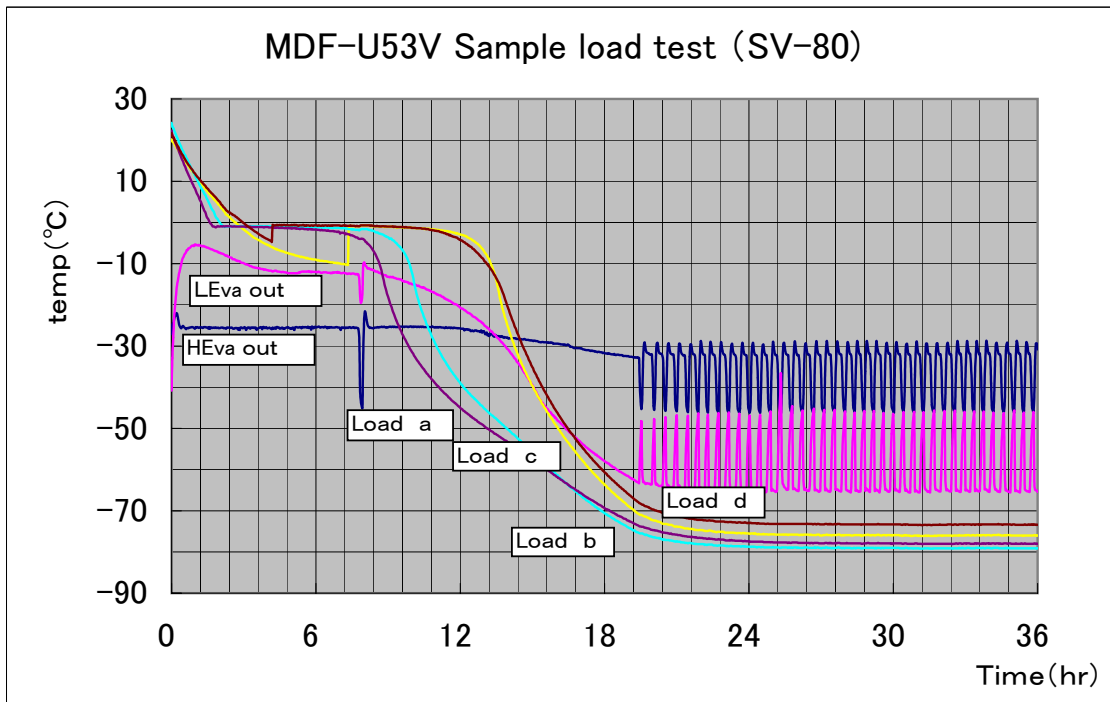
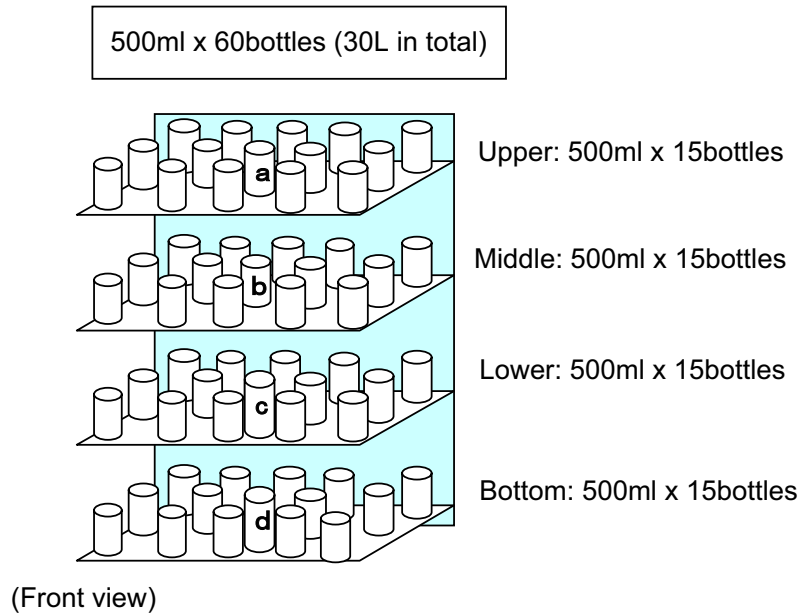

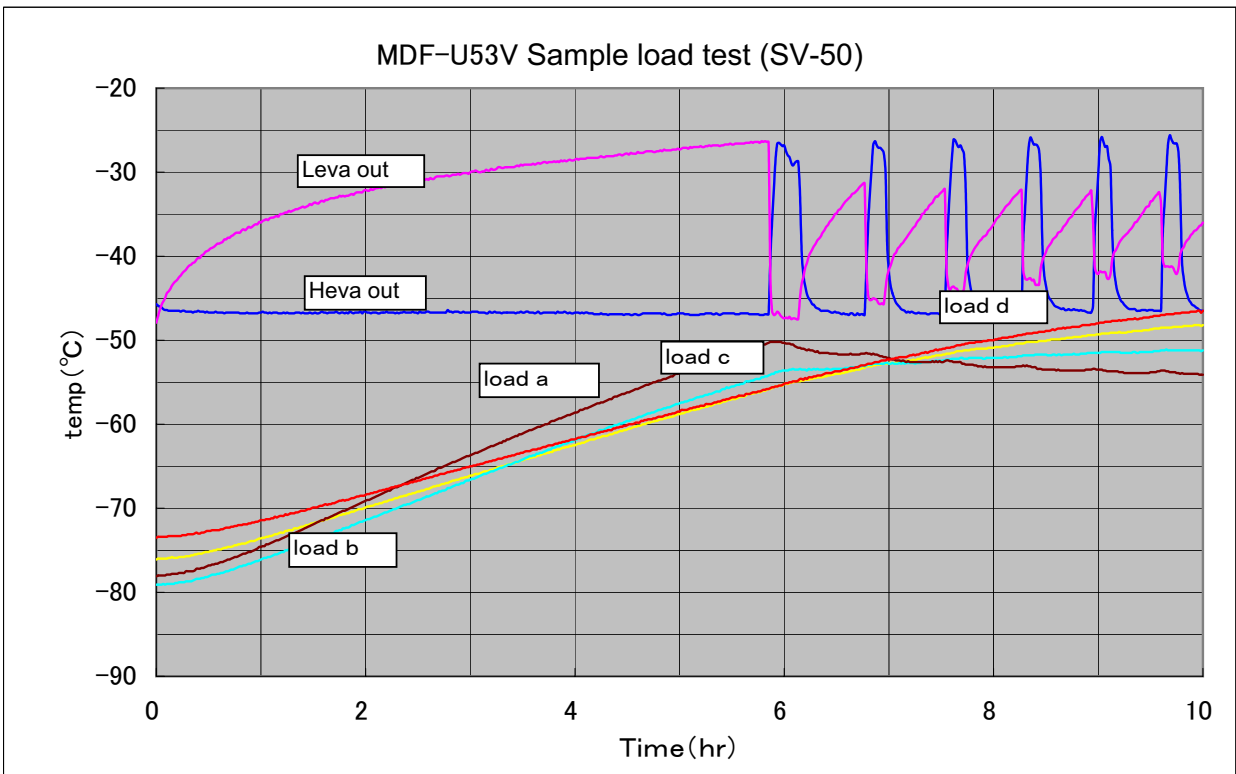
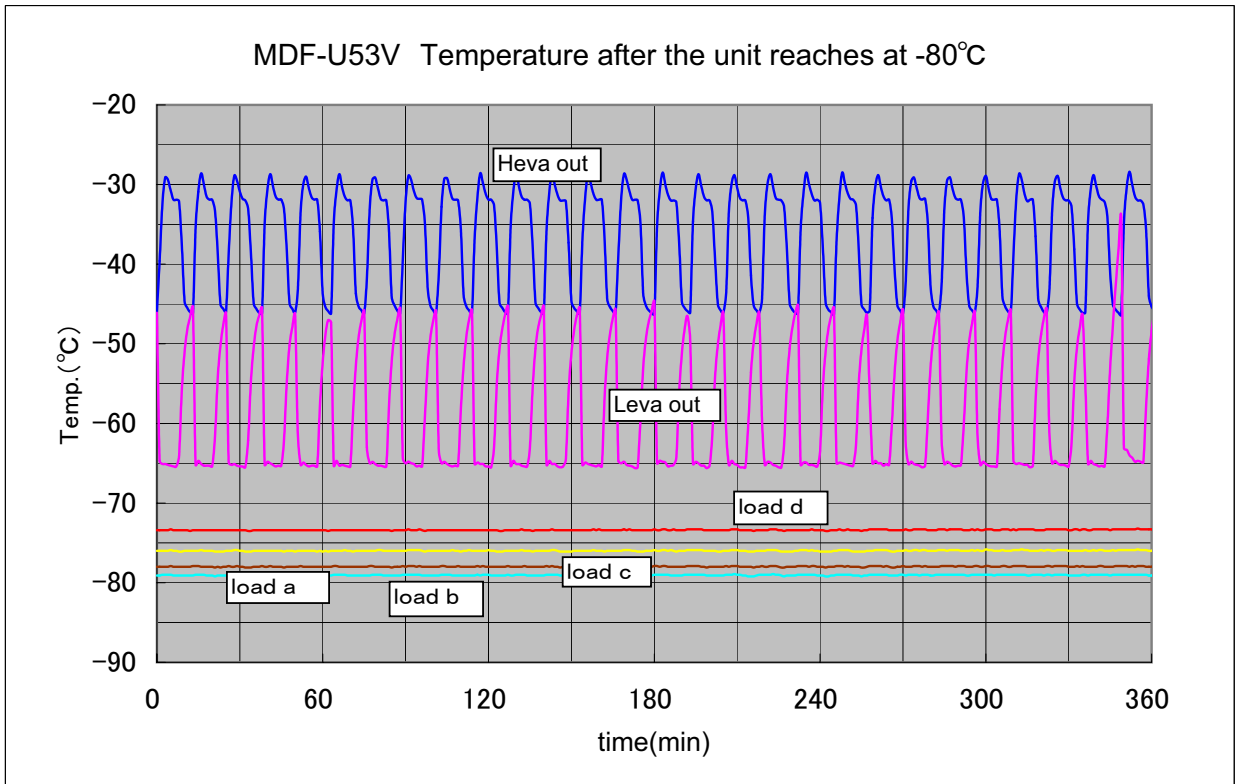

Instruction manual

- This section is extracted and printed from Instruction Manual.
- If you find out “Refer to page ●●” in them, this page means not page in Service manual but page in the lower corner of each page in the extract from Instruction manual.
This page number is not corresponded with serial number in Service manual.

INSTRUCTION MANUAL

Ultra-Low Temperature Freezer

MDF-U73V
MDF-U73VC
MDF-U53V
MDF-U53VC



MDF-U73V/MDF-U73VC

CONTENTS

| | |
|---------------------------------|------|
| INTRODUCTION | P. 2 |
| PRECAUTIONS FOR SAFE OPERATION | P. 3 |
| ENVIRONMENTAL CONDITIONS | P. 7 |
| FREEZER COMPONENTS | P. 8 |
| Control panel | P.10 |
| INSTALLATION SITE | P.11 |
| INSTALLATION | P.12 |
| START-UP OF UNIT | P.13 |
| CHAMBER TEMPERATURE SETTING | P.14 |
| KEY LOCK FUNCTION | P.14 |
| ALARM TEMPERATURE SETTING | P.15 |
| SETTING OF ALARM RESUME TIME | P.16 |
| REMOTE ALARM TERMINAL | P.17 |
| MONITOR OF FREEZER STATUS | P.18 |
| CHANGE OF COMPRESSOR DELAY TIME | P.19 |
| CHANGE OF DOOR ALARM DELAY TIME | P.20 |
| ALARMS & SAFETY FUNCTIONS | P.21 |
| ROUTINE MAINTENANCE | |
| Cleaning of cabinet | P.22 |
| Cleaning of condenser filter | P.22 |
| Defrosting of inside wall | P.23 |
| TROUBLESHOOTING | P.24 |
| REPLACEMENT OF BATTERY | P.25 |
| DISPOSAL OF UNIT | P.26 |
| Recycle of battery | P.26 |
| TEMPERATURE RECORDER (OPTION) | P.31 |
| BACK-UP SYSTEM (OPTION) | P.32 |
| INVENTORY RACK (OPTION) | P.33 |
| SPECIFICATIONS | P.34 |
| PERFORMANCE | P.36 |
| SAFETY CHECK SHEET | P.37 |

INTRODUCTION

- Read this manual carefully before using the appliance and follow the instructions for safety operation.

- Sanyo never guarantee any safety if the appliance is used for any objects other than intended use or used by any procedures other than those mentioned in this manual.

- Keep this manual in an adequate place to refer to it as necessary.

- The contents of the manual will be subjected to change without notice due to the improvement of performance or functions.

- Contact Sanyo sales representative or agent if any page of the manual is lost or page order is incorrect.

- Contact Sanyo sales representative or agent if any point in this manual is unclear or if there are any inaccuracies.

- No part of this manual may be reproduced in any form without the expressed written permission of Sanyo.

PRECAUTIONS FOR SAFE OPERATION

It is imperative that the user complies with this manual as it contains important safety advice.

Items and procedures are described so that you can use this unit correctly and safely. If the precautions advised are followed, this will prevent possible injury to the user and any other person.

Precautions are illustrated in the following way:



WARNING

Failure to observe WARNING signs could result in a hazard to personnel possibly resulting in serious injury or death.

CAUTION

Failure to observe CAUTION signs could result in injury to personnel and damage to the unit and associated property.

Symbol shows;

-  this symbol means caution.
-  this symbol means an action is prohibited.
-  this symbol means an instruction must be followed.

Be sure to keep this manual in a place accessible to users of this unit.

< Label on the unit >



This mark is labeled on the cover in which the electrical components of high voltage are enclosed to prevent the electric shock.

The cover should be removed by a qualified engineer or a service personnel only.

WARNING

As with any equipment that uses CO₂ gas, there is a likelihood of oxygen depletion in the vicinity of the equipment. It is important that you assess the work site to ensure there is suitable and sufficient ventilation. If restricted ventilation is suspected, then other methods of ensuring a safe environment must be considered. These may include atmosphere monitoring and warning devices.













PRECAUTIONS FOR SAFE OPERATION

WARNING

-  **Do not use the unit outdoors.** Current leakage or electric shock may result if the unit is exposed to rain water.
-  **Only qualified engineers or service personnel should install the unit.** The installation by unqualified personnel may cause electric shock or fire.
-  **Install the unit on a sturdy floor and take an adequate precaution to prevent the unit from turning over.** If the floor is not strong enough or the installation site is not adequate, this may result in injury from the unit falling or tipping over.
-  **Never install the unit in a humid place or a place where it is likely to be splashed by water.** Deterioration of the insulation may result which could cause current leakage or electric shock.
-  **Never install the unit in a flammable or volatile location.** This may cause explosion or fire.
-  **Never install the unit where acid or corrosive gases are present** as current leakage or electric shock may result due to corrosion.
-  **Always ground (earth) the unit to prevent electric shock.** If the power supply outlet is not grounded, it will be necessary to install a ground by qualified engineers.
-  **Never ground the unit through a gas pipe, water main, telephone line or lightning rod.** Such grounding may cause electric shock in the case of an incomplete circuit.
-  **Connect the unit to a power source as indicated on the rating label attached to the unit.** Use of any other voltage or frequency other than that on the rating label may cause fire or electric shock.
-  **Never store volatile or flammable substances** in this unit if the container cannot be sealed. These may cause explosion or fire.
-  **Do not insert metal objects such as a pin or a wire into any vent, gap or any outlet on the unit.** This may cause electric shock or injury by accidental contact with moving parts.
-  **Use this unit in safe area when treating the poison, harmful or radiate articles.** Improper use may cause bad effect on your health or environment.
-  **Turn off the power switch (if provided) and disconnect the power supply to the unit prior to any repair or maintenance** of the unit in order to prevent electric shock or injury.
-  **Do not touch any electrical parts (such as power supply plug) or operate switches with a wet hand.** This may cause electric shock.







PRECAUTIONS FOR SAFE OPERATION

WARNING

-  **Ensure you do not inhale or consume medication or aerosols** from around the unit at the time of maintenance. These may be harmful to your health.
-  **Never splash water directly onto the unit** as this may cause electric shock or short circuit.
-  **Never put containers with liquid on the unit** as this may cause electric shock or short circuit when the liquid is spilled.
-  **Never bind, process, or step on the power supply cord, or never damage or break the power supply plug.** A broken supply cord or plug may cause fire or electric shock.
-  **Do not use the supply cord if its plug is loose.** Such supply cord may cause fire or electric shock.
-  **Never disassemble, repair, or modify the unit yourself.** Any such work carried out by an unauthorized person may result in fire, or electric shock or injury due to a malfunction.
-  **Disconnect the power supply plug if there is something wrong with the unit.** Continued abnormal operation may cause electric shock or fire.
-  **When removing the plug from the power supply outlet, grip the power supply plug,** not the cord. Pulling the cord may result in electric shock or fire by short circuit.
-  **Disconnect the power supply plug** before moving the unit. Take care not to damage the power cord. A damaged cord may cause electric shock or fire.
-  **Disconnect the power plug when the unit is not used for long periods.** Keeping the connection may cause electric shock, current leakage, or fire due to the deterioration of insulation.
-  If the unit is to be stored unused in an unsupervised area for an extended period, **ensure that children do not have access and that doors cannot be closed completely.**
-  **The disposal of the unit should be accomplished by appropriate personnel.** Remove doors to prevent accidents such as suffocation.
-  **Do not put the packing plastic bag within reach of children** as suffocation may result.

PRECAUTIONS FOR SAFE OPERATION

CAUTION

-  **Use a dedicated power source** (a dedicated circuit with a breaker) as indicated on the rating label attached to the unit. A branched circuit may cause fire resulting from abnormal heating.
-  **Connect the power supply plug to the power source firmly after removing the dust on the plug.** A dusty plug or improper insertion may cause a heat or ignition.
-  **Never store corrosive substances such as acid or alkali** in this unit if the container cannot be sealed. These may cause corrosion of inner components or electric parts.
-  **Check the setting when starting up of operation after power failure or turning off of power switch.** The stored items may be damaged due to the change of setting.
-  **Be careful not to tip over the unit** during movement to prevent damage or injury.
-  **Prepare a safety check sheet** when you request any repair or maintenance for the safety of service personnel.

ENVIRONMENTAL CONDITIONS

This equipment is designed to be safe at least under the following conditions (based on the IEC-1010-1):

- Indoor use;
- Altitude up to 2000 m;
- Ambient temperature 5°C to 40°C
- Maximum relative humidity 80% for temperature up to 31°C decreasing linearly to 50% relative humidity at 40°C;
- Mains supply voltage fluctuations not to exceed $\pm 10\%$ of the nominal voltage;
- Other supply voltage fluctuations as stated by the manufacturer;
- Transient overvoltages according to Installation Categories (Overvoltage Categories) II; For mains supply the minimum and normal category is II;
- Pollution degree 2 in accordance with IEC 664.

FREEZER COMPONENTS

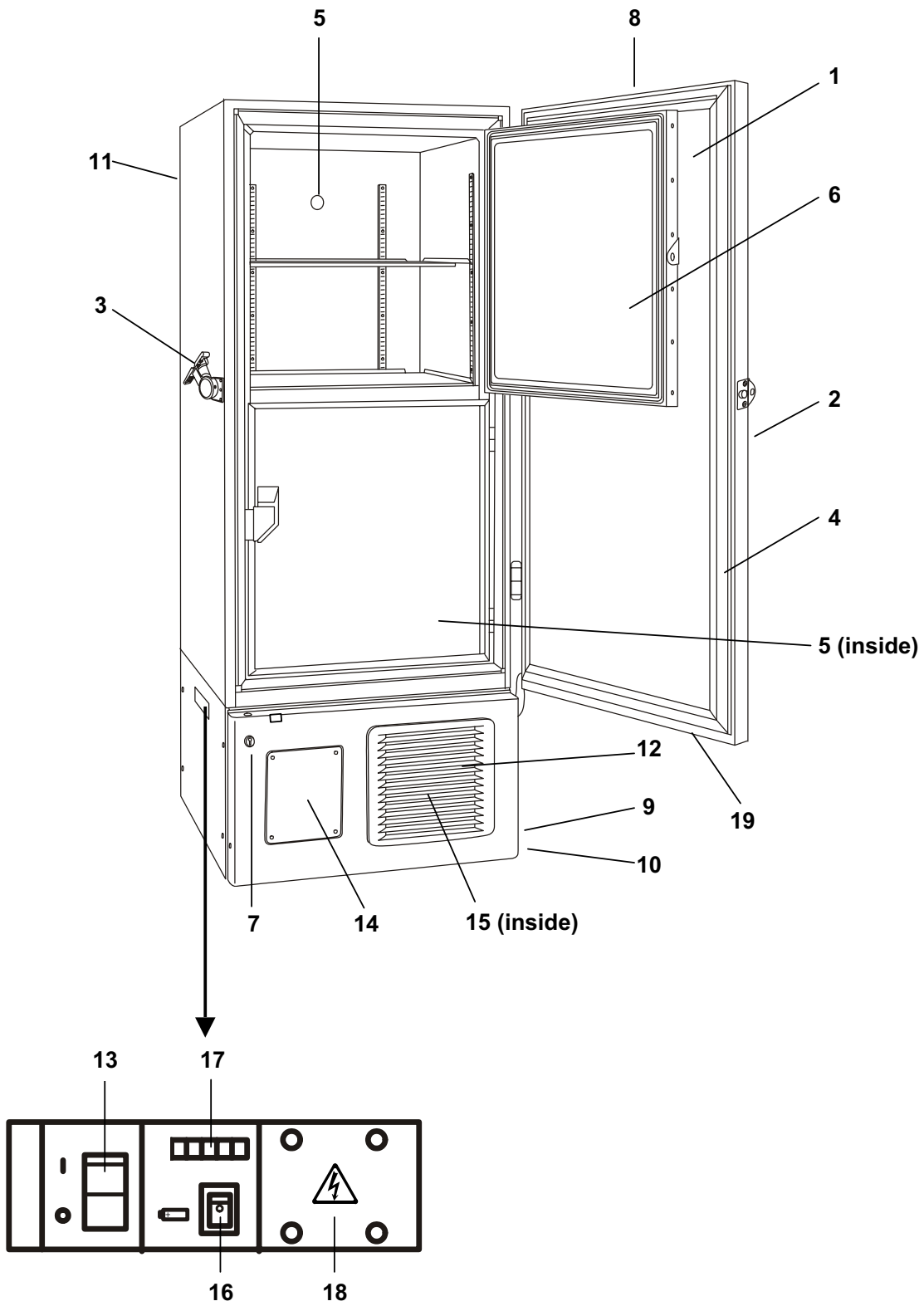

FREEZER COMPONENTS

- 1. Outer door:** To open the door, grip the handle. On closing, lock the door latch completely.
- 2. Handle:** Always grip this handle to open and close the outer door.
- 3. Door latch:** Always lock the latch when the outer door is closed.
- 4. Magnetic door gasket:** This provides a tight door seal and prevents cold air leak. Keep clean.
- 5. Access port (rear and bottom):** This is used for leading a cable and sensor of a measuring equipment, or nozzle of back-up system to chamber.
- 6. Inner door:** The operation of the inner door should be quick to minimize the temperature rise in chamber. Lock the door latch completely when the door is closed. The door is removable for cleaning or defrosting. See page 23 "Routine maintenance".
- 7. Lock:** Turn clockwise to 180° with a key and the outer door is securely locked.
- 8. Control panel (on the upper front of the door):** Used for temperature setting and indication of operating status is displayed on the panel. See page 10 for details.
- 9. Caster:** 4 casters are provided to facilitate moving of the cabinet. For the installation, adjust the leveling foot so that the front 2 casters cannot contact with the floor.
- 10. Leveling foot:** The height of the freezer can be adjusted by this screw type foot. Keep the unit in level at the installation.
- 11. Fixture (on back side):** 2 fixtures are provided as spacers between the cabinet and wall and also serve as hooks to fix the unit. See page 12 "Installation".
- 12. Air intake vent (grille):** Do not block this vent to keep the proper cooling performance.
- 13. Power switch:** This is for turning ON/OFF the power to the unit. ON – "I" OFF – "○"
- 14. Space for temperature recorder:** An automatic temperature recorder (optional component) can be attached here. See page 31 "Temperature recorder (Option)".
- 15. Condenser filter (behind the grille):** This filter prevents the dust from accumulating on the condenser. The dusty filter may cause failure of refrigerating device. Clean the filter once a month. See page 22 "Routine maintenance" for the cleaning.
- 16. Battery switch:** This is a switch for a battery for power failure alarm. Normally, turn on this switch. Be sure to turn off this switch if the freezer is not in operating for the long period (over one month).
- 17. Remote alarm terminal:** This is used to notice an alarm condition of the unit to remote location. Refer to page 18 "Remote alarm terminal".
- 18. Space for optional component:**
- 19. Door switch:** This switch detects the open/close status of outer door.

FREEZER COMPONENTS

Control panel

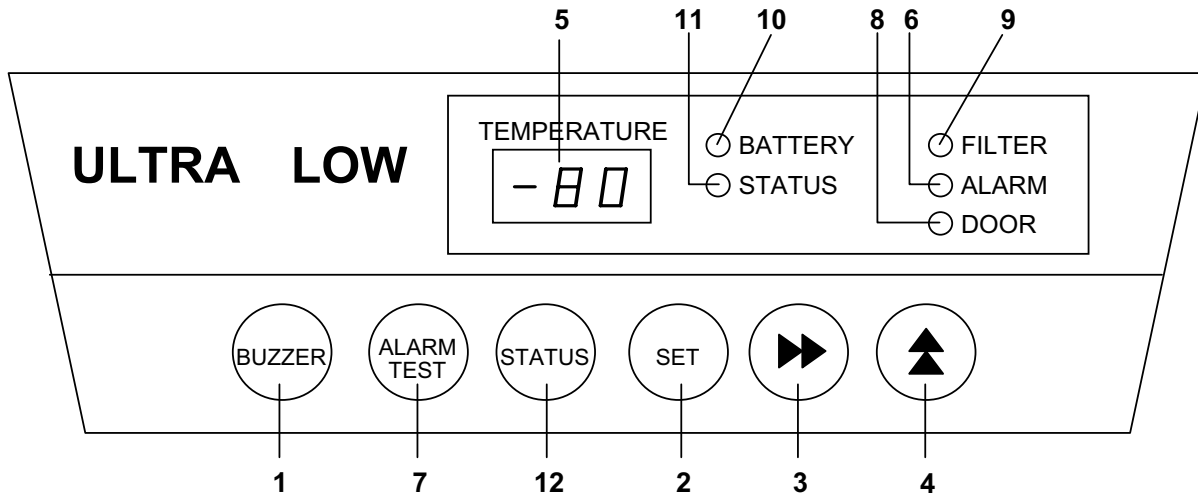

1. Buzzer stop key (BUZZER): To silence the audible alarm under alarm condition, press this key. The buzzer during alarm test cannot be silenced by this key.

2. Set key (SET): Temperature setting mode is led by pressing this key and the changeable digit is flashed. By pressing this key again, the setting is memorized. The set mode returns to the temperature display mode automatically when 90 seconds has passed without any key operation. Refer to page 14 for details.

3. Digit shift key (▶▶): Pressing this key in the setting mode causes the changeable digit to shift. Key lock is available by pressing this key for more than 5 seconds in the temperature display mode. Refer to page 14 for details.

4. Numerical value shift key (▲): Pressing this key in the setting mode causes the numerical value to shift. ON-OFF of key lock can be selected by pressing this key in the key lock mode. By pressing this key for more than 5 seconds in the temperature display mode leads setting mode for alarm temperature and alarm resume time. Refer to page 14 and 15 for details respectively.

5. Digital temperature indicator: This indicator shows the present chamber temperature or set temperature.

6. Alarm lamp (ALARM): This lamp is flashed during alarm condition.

7. Alarm test key (ALARM TEST): To check the alarm system during freezer operation. Pressing this key with the battery switch ON gets the alarm lamp to flash, the remote alarm to operate, and the buzzer to sound.

8. Door check lamp (DOOR): This lamp lights when the door is open.

9. Filter check lamp (FILTER): This lamp lights when the excessive dust is accumulated on the condenser filter. When this lamp lights, clean the condenser filter following the procedure on page 22.

10. Battery check lamp (BATTERY): This lamp lights to recommend the battery replacement. This lamp blinks when a fan motor is maintained. For the replacement, consult Sanyo sales representative or agent.

11. Status monitor lamp (STATUS): This lamp lights when environmental condition or status gets worse or the unit is out of normal operation.

12. Status key (STATUS): By pressing this key in the event of the status monitor lamp ON, the status code is displayed on the temperature indicator. This key is not effective when the freezer is running normally. See page 19 for details.

INSTALLATION SITE

To operate this unit properly and to obtain maximum performance, install the unit in a location with the following conditions:

1. A location not subjected to direct sunlight

Installation in a location subjected to direct sunlight may lead to inadequate cooling.

2. A location with adequate ventilation

Leave at least 10 cm around the unit for ventilation. Poor ventilation will result in a reduction of the refrigeration capacity.

3. A location away from heat generating sources

Avoid installing the unit near heat-emitting appliances such as gas ranges or stoves. Heat can cause inefficient refrigeration.

4. A location not prone to high humidity

WARNING

Install the unit on a sturdy floor. If the floor is not strong enough or the installation site is not adequate, this may result in injury from the unit falling or tipping over.

Select a level and sturdy floor for installation. This precaution will prevent the unit from tipping. Improper installation may result in water spillage or injury from the unit tipping over.

▪ A location not prone to high humidity

WARNING

Do not use the unit outdoors. Current leakage or electric shock may result if the unit is exposed to rain water.

Never install the unit in a humid place or a place where it is likely to be splashed by water. Deterioration of the insulation may result which could cause current leakage or electric shock.

▪ A location without flammable or corrosive gas

WARNING

Never install the unit in a flammable or volatile location. This may cause explosion or fire.

Never install the unit where acid or corrosive gases are present as current leakage or electric shock may result due to corrosion.

INSTALLATION

1. Remove the packaging materials and tapes

Remove all transportation packaging materials and tapes. Open the doors and ventilate the unit. If the outside panels are dirty, clean them with a diluted neutral dishwashing detergent. (Undiluted detergent can damage the plastic components. For the dilution, refer to the instruction of the detergent.) After the cleaning with the diluted detergent, always wipe it off with a wet cloth. Then wipe off the panels with a dry cloth.

2. Adjust the leveling foot

Extend the leveling feet by rotating them counterclockwise to contact them to the floor. Ensure the unit is level. (Fig.1)

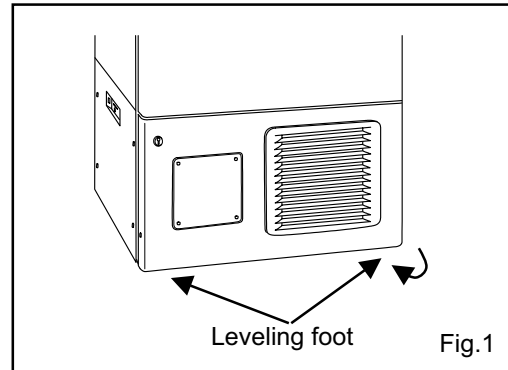

3. Fix the unit

Two fixtures are attached to the rear of the frame. Fix the frame to the wall with these fixtures and rope or chain. (Fig. 2)

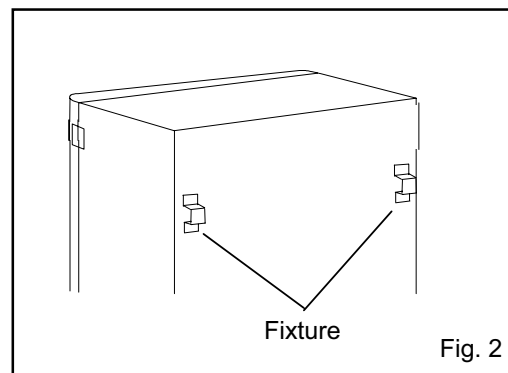

4. Ground (earth)

⚠️ WARNING

Use a power supply outlet with ground (earth) to prevent electric shock. If the power supply outlet is not grounded, it is necessary to install a ground by qualified engineers.

Never ground the unit through a gas pipe, water main, telephone line or lightning rod. Such grounding may cause electric shock in the case of an incomplete circuit.

START-UP OF UNIT

Follow the procedures for the initial and consequent operations of the unit.



1. Connect the power cord to the dedicated outlet having appropriate rating with the chamber empty, and turn on the power switch on the freezer.
2. Turn off the switch of the back-up system (optional component) if it is installed.
3. Check that the battery switch is ON.
4. The audible alarm may activated. In this case, press the buzzer stop key (BUZZER) to silence the alarm.
5. Set the desired chamber temperature. See page 14 for the temperature setting.
6. Check that the chamber temperature reaches the desired temperature.
7. Turn on the switch of back-up system (optional component) if it is installed.
8. Check that the alarm lamp lights and the buzzer sounds by pressing the alarm test key.
9. After confirming the above, you can put articles into the freezer chamber in a small batch to prevent the temperature rise.

CHAMBER TEMPERATURE SETTING

Table 1 shows the basic procedure for setting the chamber temperature. Perform key operations in the sequence indicated in the table. The example in the table is based on the assumption that the desired temperature is -75°C .

Note: The unit is set at the factory that the chamber temperature -80°C .

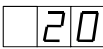
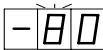
Table 1. Basic operation sequence (Example: Chamber temperature -75°C)

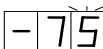
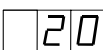
| | Description of operation | Key operated | Indication after operation |
|---|--|---|--|
| 1 | Turn the power switch ON. | ---- | The current chamber temperature is displayed.  |
| 2 | Press set key. | SET | The second digit is flashed.  |
| 3 | Set to -75 with the numerical value shift key and digit shift key. |  | When pressed, the figure of settable digit changes. |
| | |  | When pressed, the settable digit is shifted.  |
| 4 | Press set key. | SET | Set temperature is memorized and the current chamber temperature is displayed.  |

Note:



- The temperature set mode returns to the temperature display mode automatically when 90 seconds has passed without any key operation.
- Although the value of the chamber temperature setting can range from -50°C to -90°C , the guaranteed temperature when there is no load is -85°C when the ambient temperature is 30°C .

KEY LOCK FUNCTION

This unit is provided with the key lock function. When the key lock is ON, change of temperature setting through the key pad is not available. The key lock is set in OFF at the factory.

| Display | Mode | Function |
|---------|-----------------|--|
| L 0 | Key lock is OFF | Enable to change of temperature setting |
| L 1 | Key lock is ON | Disable to change of temperature setting |

Table 2. Procedure for key lock setting (change from key lock OFF to key lock ON)

| | Description of operation | Key operated | Indication after operation |
|---|---|---|--|
| 1 | | ---- | The current chamber temperature is displayed. |
| 2 | Press digit shift key for 5 seconds. |  | The first digit is flashed. |
| 3 | Press numerical value shift key and scroll the figure to 1. |  | When pressed, the figure of settable digit changes. |
| 4 | Press set key. | SET | The key lock is set to ON. The current chamber temperature is displayed. |

ALARM TEMPERATURE SETTING

This unit is provided with the high and low temperature alarm and the temperature at which the alarm is activated is changeable.

The following procedure shows the setting of alarm temperature according to the condition below:

- High temperature alarm: activates at the temperature 5°C higher than the set temperature
- Low temperature alarm: activates at the temperature 5°C lower than the set temperature

Note:

The alarm temperature is set at the factory 10°C higher and lower than the set temperature.

The available range of alarm temperature is between 5°C and 20°C higher or lower than the set temperature.

Table 3. Procedure for setting high temperature alarm

| | Description of operation | Key operated | Indication after operation |
|---|---|--------------|--|
| 1 | | ---- | The current chamber temperature is displayed. |
| 2 | Press numerical value shift key for about 5 seconds. | ▲▲ | The first digit is flashed. |
| 3 | Press numerical value shift key and scroll the figure to 1. | ▲▲ | The first digit is flashed. |
| 4 | Press set key. | SET | The first digit is flashed. |
| 5 | Scroll the figure to 005 by using digit shift key and numerical value shift key | ▲▲ | When pressed, the figure of settable digit changes. |
| | | ▶▶ | When pressed, the changeable digit moves. |
| 6 | Press set key. | SET | Alarm temperature is memorized and the current chamber temperature is displayed. |

Table 4. Procedure for setting low temperature alarm

| | Description of operation | Key operated | Indication after operation |
|---|---|--------------|--|
| 1 | | ---- | The current chamber temperature is displayed. |
| 2 | Press numerical value shift key for about 5 seconds. | ▲▲ | The first digit is flashed. |
| 3 | Press numerical value shift key and scroll the figure to 2.. | ▲▲ | The first digit is flashed. |
| 4 | Press set key. | SET | The first digit is flashed. |
| 5 | Scroll the figure to -05 by using digit shift key and numerical value shift key | ▲▲ | When pressed, the figure of settable digit changes. |
| | | ▶▶ | When pressed, the changeable digit moves. |
| 6 | Press set key. | SET | Alarm temperature is memorized and the current chamber temperature is displayed. |

SETTING OF ALARM RESUME TIME

The alarm buzzer is silenced by pressing buzzer stop key (BUZZER) on the control panel during alarm condition (The remote alarm is not silenced).

The buzzer will be activated again after certain suspension if the alarm condition is continued. The suspension time can be set by following the procedure shown in the Table 6 below.

The example in the table is based on the assumption that the desired duration is 20 minutes.

Note: The duration is set in 30 minutes at the factory.

Table 6. Setting procedure for alarm resuming time (change from 30 minutes to 20 minutes)

| | Description of operation | Key operated | Indication after operation |
|---|---|--------------|--|
| 1 | | ---- | The current chamber temperature is displayed. |
| 2 | Press digit shift key for 5 seconds. | | The first digit is flashed. |
| 3 | Set the figure to F25 with the digit shift key and numerical value shift key. | | The settable digit is shifted. |
| | | | When pressed, the figure of settable digit changes. |
| 4 | Press set key. | SET | The current reset time is displayed. The middle digit is flashed. |
| 5 | Set the figure to 020 with the numerical value shift key. | | When pressed, the figure of settable digit changes. |
| 6 | Press set key. | SET | The setting is memorized and the current chamber temperature is displayed. |

- The settable alarm resume time is 10, 20, 30, 40, 50, or 60 minutes (The setting is 010, 020, 030, 040, 050, or 060). The buzzer would not reset if the reset time is set in 000.
- It is recommended to set the alarm resume time when the freezer is not under alarm condition. The setting during alarm condition is effective on the next alarm condition.
- The setting cannot be changed during power failure.
- The remote alarm during power failure or buzzer and remote alarm during alarm test cannot be silenced.
- The set mode returns to the temperature display mode automatically when 90 seconds has passed without any key operation. In this case, any setting before pressing set key (SET) is not memorized.

REMOTE ALARM TERMINAL

The terminal of the remote alarm is installed at the lower left side of the unit. The alarm is outputted from this terminal. Contact capacity is DC 30 V, 2 A.

Contact output:

| | | |
|-------------|-----------------------|-----------------------|
| | between COM. and N.O. | between COM. and N.C. |
| At normal | Open | Close |
| At abnormal | Close | Open |

Note:

The alarm is actuated when the power cord is disconnected from the outlet or the power switch is OFF.

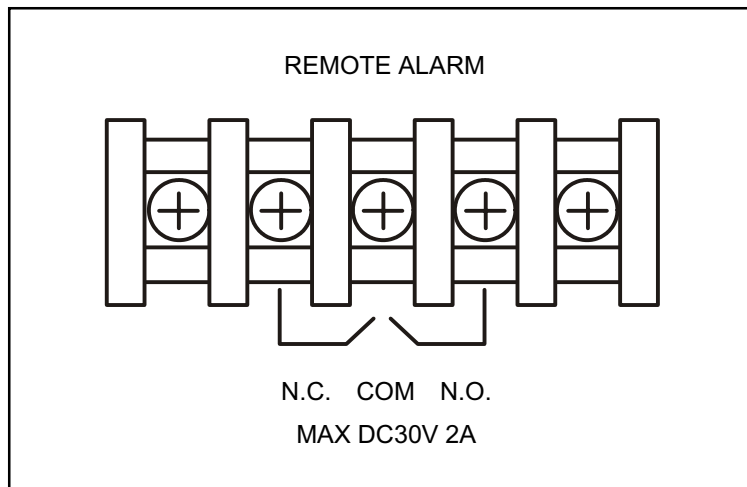

MONITOR OF FREEZER STATUS

The freezer has a function to monitor the running status of the unit as shown in table 7 below. This is to notice the running status getting worse (not failure).

1. The status monitor lamp is lit when one of the running status shown in table 7 is detected.
2. The S code (--X, X: 1 to 3) is displayed on the temperature indicator by pressing STATUS key when the STATUS lamp is lit.
3. Pressing the STATUS key again returns to current chamber temperature on the temperature indicator. (The indication returns to the chamber temperature display automatically when no key is operated for 90 seconds.)

Table 7. Monitor of running status

| Kind of function | Status | Indication | If this status continues | Remedy |
|--|---|--|--|--|
| Notice of abnormal ambient temperature | When the ambient temp. is over approx. 35°C or lower than about 0°C. | STATUS lamp lights. "--1" is displayed. | Decrease of cooling performance or durability of refrigerating circuit. | Recheck air-conditioning of installed site. |
| Notice of low voltage | When the power source voltage is less than approx. 195V when the rated voltage is between 220 and 240V. | STATUS lamp lights. "--2" is displayed. | Abnormal heat at power supply outlet or degrade of starting performance of refrigerating circuit | Use dedicated power source. |
| Notice of overload condition | When the running rate of refrigerating Circuit is higher than usual. | STATUS lamp lights. "--3" is displayed. | Decrease of cooling performance or durability of refrigerating circuit. | 1. This is likely to happen when a large amount of materials is stored. 2. Check ambient temp., voltage, and sealing of outer/inner door. |

Note:

- The S code displayed on the temperature indicator is changed every few seconds if two or three status shown in the above table are detected at the same time. (--1 ⇒ --2 ⇒ --3 ⇒ --1 repeated)
- The monitoring function does not trigger a buzzer or conduct a safety operation.
the case of multiple indication of S code, follow the remedy for each status.
- The status monitor lamp (STATUS) may be lit under normal running condition when the independent inner door (MDF-7ID or MDF-5ID) is installed because of less cooling performance. In this case, adjust the air conditioning so that the ambient temperature is around 23°C, or set the chamber temperature 10°C higher than the current setting.

CHANGE OF COMPRESSOR DELAY TIME

The delay time of high and low stage side compressor can be changed to reduce the load on the power line and to facilitate the start-up (reset) of the freezer after power failure.

The example in the table is based on the assumption that the delay time is changed to 4 minutes. (The delay time is set in 2 minutes at the factory.)

Note:

- The delay time should be the same for high stage side and low stage side compressors.
- The setting range for delay time is between 2 and 15 minutes. The cool down of chamber temperature may be slow when the setting of delay time is over 5 minutes, depending on the installation environment. There is no need of changing the delay time when the capacity of power source is adequate.

Table 8. Changing procedure for delay time (change from 2 minutes to 4 minutes)

| | Description of operation | Key operated | Indication after operation |
|---|---|--------------|---|
| 1 | | ---- | The current chamber temperature is displayed. |
| 2 | Press numerical value shift key for 5 seconds. | | The first digit is flashed. |
| 3 | Set the figure to F05 with the numerical value shift key. | | When pressed, the figure of settable digit changes. |
| 4 | Press set key. | SET | The current delay time is displayed. The first digit is flashed. |
| 5 | Set the figure to 004 with the numerical value shift key. | | When pressed, the figure of the first digit changes. |
| 6 | Press set key. | SET | The delay time is memorized and the current chamber temperature is displayed. |

- The compressor starts to operate with the delay time set by the above procedure at the time of power on or after power failure. However, the start up of the low stage side compressor is affected by the chamber temperature and the cascade condenser temperature. The delay time varies depending on how they meet the start up conditions.

CHANGE OF DOOR ALARM DELAY TIME

The buzzer of door alarm is activated with 2 minutes delay when the door is open. The delay time is changeable.

Follow the procedure in table 9 below to change the setting of delay time. The procedure assumes that the delay time is changed from 2 minutes to 3 minutes.

(The delay time is set in 2 minutes at the factory.)

Table 9. Changing procedure for delay time (change from 2 minutes to 3 minutes)

| | Description of operation | Key operated | Indication after operation |
|---|---|--------------|---|
| 1 | | ---- | The current chamber temperature is displayed. |
| 2 | Press numerical value shift key for 5 seconds. | | The first digit is flashed. |
| 3 | Set the figure to F04 with the numerical value shift key. | | When pressed, the figure of settable digit changes. |
| 4 | Press set key. | SET | The current delay time is displayed. The first digit is flashed. |
| 5 | Set the figure to 003 with the numerical value shift key. | | When pressed, the figure of the first digit changes. |
| 6 | Press set key. | SET | The delay time is memorized and the current chamber temperature is displayed. |

Note:

- The setting range for delay time is between 1 and 15 minutes.

ALARMS & SAFETY FUNCTIONS

This unit has the alarms and safety functions shown in Table 5, and also self diagnostic functions.

Table 5. Alarms and safety functions

| Alarm & Safety | Situation | Indication | Buzzer | Safety operation |
|-----------------------------|---|---|--|--|
| High temperature alarm | If the chamber temperature is higher than the temperature at which the high temperature alarm is activated. | ALARM lamp is flashed. Temperature indicator is flashed. | Intermittent tone with 15 minutes delay. | Remote alarm with 15 minutes delay. |
| Low temperature alarm | If the chamber temperature is lower than the temperature at which the low temperature alarm is activated. | | | |
| Power failure alarm | When the power to the unit is disconnected. | ALARM lamp is flashed. | Intermittent tone | Remote alarm. |
| Door alarm | When the door is open. | Door check lamp lights. | Intermittent tone with 2minutes delay. | ---- |
| Filter check | When the condenser filter is clogged. | Filter check lamp lights. | Intermittent tone | ---- |
| Battery check | When about 3 years has passed with power switch ON. | Battery check lamp lights. | ---- | ---- |
| Fan motor check | When about 5.5 years has passed with power switch ON. | Battery check lamp flashed. | ---- | ---- |
| Auto-return | When there is no key pressing in each setting mode for 90 seconds. | Chamber temperature is displayed. | ---- | Finishing of each setting mode. |
| Key lock | When the key lock is ON. | ---- | ---- | Change of setting is disable. |
| Sensor abnormality | If the thermal sensor is disconnected. | ALARM lamp is flashed. E01 and chamber temp. are displayed alternately. | Intermittent tone | Remote alarm. Unit keeps continuous running. |
| | If the thermal sensor is short-circuited. | ALARM lamp is flashed. E02 and chamber temp. are displayed alternately. | Intermittent tone | Remote alarm. Unit keeps continuous running. |
| | If the cascade sensor is disconnected. | ALARM lamp is flashed. E03 and chamber temp. are displayed alternately. | Intermittent tone | Remote alarm. |
| | If the cascade sensor is short circuited. | ALARM lamp is flashed. E04 and chamber temp. are displayed alternately. | Intermittent tone | Remote alarm. |
| | If the filter sensor is disconnected. | ALARM lamp is flashed. E05 and chamber temp. are displayed alternately. | Intermittent tone | Remote alarm. |
| | If the filter sensor is short-circuited. | ALARM lamp is flashed. E06 and chamber temp. are displayed alternately. | Intermittent tone | Remote alarm. |
| Battery switch check | When the battery switch is OFF during alarm test. | ALARM lamp is flashed. E09 is flashed. | ---- | ---- |
| Condenser temp. abnormality | In the event of failure of fan motor for cooling the compressor | E10 and chamber temp. are displayed alternately. | Intermittent tone | Remote alarm. Compressor of high stage side stops. |

Note:

- When the operation is started in high ambient temperature, the filter check lamp is sometimes flashed. In this case, the lamp is off automatically when the chamber temperature is getting lower.
- The freezer resumes the operation after power failure with the temperature setting before power failure as the chamber temperature setting and alarm temperature setting are memorized in the volatile memory.
- The chamber temperature is displayed for 5 seconds by pressing buzzer stop key (BUZZER) during power failure alarm. Then the buzzer is silenced. The alarm lamp keeps flashing.

ROUTINE MAINTENANCE

WARNING

Always disconnect the power supply to the unit prior to any repair or maintenance of the unit in order to prevent electric shock or injury.

Ensure you do not inhale or consume medication or aerosols from around the unit at the time of maintenance. These may be harmful to your health.

Cleaning of cabinet

- Clean the unit once a month. Regular cleaning keeps the unit looking new.
- Use a dry cloth to wipe off small amounts of dirt on the outside and inside of the unit and all accessories. If the outside panels are dirty, clean them with a diluted neutral dishwashing detergent.. (Undiluted detergent can damage the plastic components. For the dilution, refer to the instruction of the detergent.)

After the cleaning with the diluted detergent, always wipe it off with a wet cloth. Then wipe off the cabinet or accessories with a dry cloth.

- Never pour water onto or into the unit. Doing so can damage the electric insulation and cause failure.
- The compressor and other mechanical part are completely sealed. This unit requires absolutely no lubrication.
- There is a fan behind the compressor, so be very careful if you stick your hand into this part of the unit.

Cleaning of condenser filter

This unit is provided with the filter check lamp on the control panel. Clean the filter when this lamp lights. Clean the filter once a month even if the check lamp is not on since a clogged filter may cause shorter compressor life as well as the poor cooling.

Clean the filter by the procedure below.

1. Open the grille by pulling it to you as shown in the figure.
2. Take out the condenser filter.
3. Wash the filter with water.
4. Replace the filter and the grille.
5. Check that the filter check lamp is off in the event the check lamp was ON.

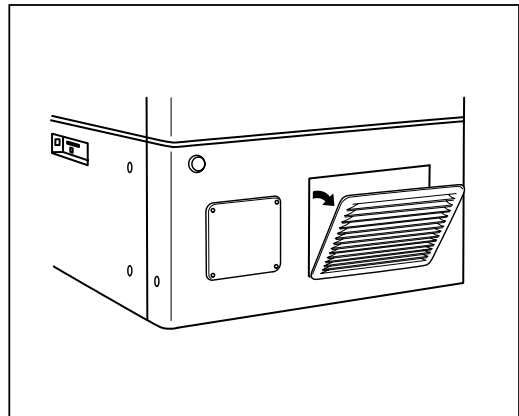

WARNING

Do not touch the condenser directly when the filter is removed for cleaning. This may cause injury by hot surface.

ROUTINE MAINTENANCE

Defrosting of inside wall

The frost is built at the upper portion of the chamber and inner door. The excessive frost possibly make some gap between the cabinet and door gasket, which may cause poor cooling. Remove the frost on the inner door with a scraper enclosed with the unit. Following shows the procedure for removing the chamber frost.

Note: For removing the frost, do not use a tool with sharp edge such as a knife or a screw driver.

1. Turn off the back-up system if applicable.
2. Take out and transfer all the contents to another freezer or a container which is refrigerated by liquid carbon dioxide or dry ice.
3. Turn off the power switch of the freezer.
4. Open the outer door and inner door. Remove the inner door by lifting up as shown in the figure.
5. Leave the freezer as it is.
6. The water accumulated on the bottom of the chamber should be wiped up with a dry cloth.
7. After cleaning the chamber and inner door, replace the inner door and start up the unit according to the procedure on page 14.
8. Put back the articles into the sufficiently cooled freezer compartment.
9. Turn on the back-up system if it is provided.

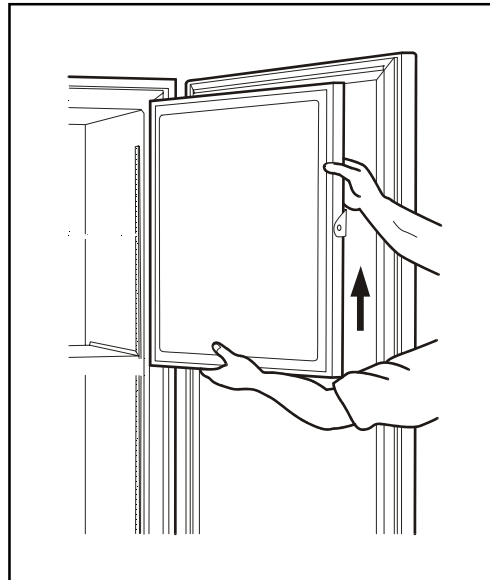

TROUBLE SHOOTING

If the unit malfunctions, check out the following before calling for service.

| Malfunction | Check/Remedy |
|---|--|
| The chamber is not cooled at all | <ul style="list-style-type: none"> ▪ The circuit breaker of power source is active. ▪ The voltage is too low (In this case, call an electrician). ▪ The power is not supplied. ▪ The breaker is free. ▪ The large amount of articles (load) is stored in the chamber at one time. |
| The cooling is poor | <ul style="list-style-type: none"> ▪ The ambient temperature is too high. ▪ The latch of inner door is not closed completely. The outer door is not closed firmly. (The frost or ice between the cabinet and door gasket possibly prevents door seal.) ▪ The air intake vent is blocked. ▪ The condenser filter is clogged. Always clean the filter when the filter check lamp is lit. ▪ The door is not shut tightly. ▪ The inner door is not installed correctly. ▪ The set temperature in the controller is not set properly. ▪ The grille is blocked out. ▪ The filter is clogged. ▪ The freezer is in the direct sunlight. ▪ There is any heating source near the freezer. ▪ A rubber cap and insulation are not set correctly. ▪ You put too many unfrozen articles into the chamber. |
| Alarm test key cannot actuate the alarm | <ul style="list-style-type: none"> ▪ The alarm is activated only when the power switch is ON. ▪ When only the buzzer or only the alarm is actuated by the alarm test key, the unactuated part is out of order, and must be replaced. |

Note:

If the malfunction is not eliminated after checking the above items, or the malfunction is not shown in the above table, contact Sanyo sales representative or agent.

REPLACEMENT OF BATTERY

Location of a nickel-metal-hydride battery

This unit is provided a nickel-metal-hydride battery for the power failure warning device. The battery is located in the electrical box inside the cover on the lower left side. (Fig. 1)



The high voltage components are enclosed in the electrical box. The cover should be removed by a qualified engineer or a service personnel only to prevent the electric shock..

Removal of nickel-metal-hydride battery

1. Turn off the power switch and disconnect the power supply plug.
2. As shown in the Fig. 2, remove 4 screws fixing the side cover with a screw driver and remove the side cover..
3. Remove 4 screws fixing the electrical box cover with a screw driver. (Fig. 3)
4. Disconnect the battery connector and remove 2 screws fixing the battery mounting plate. (Fig. 4)
5. Take out the battery.
6. Follow the procedure for recycling or proper disposal.

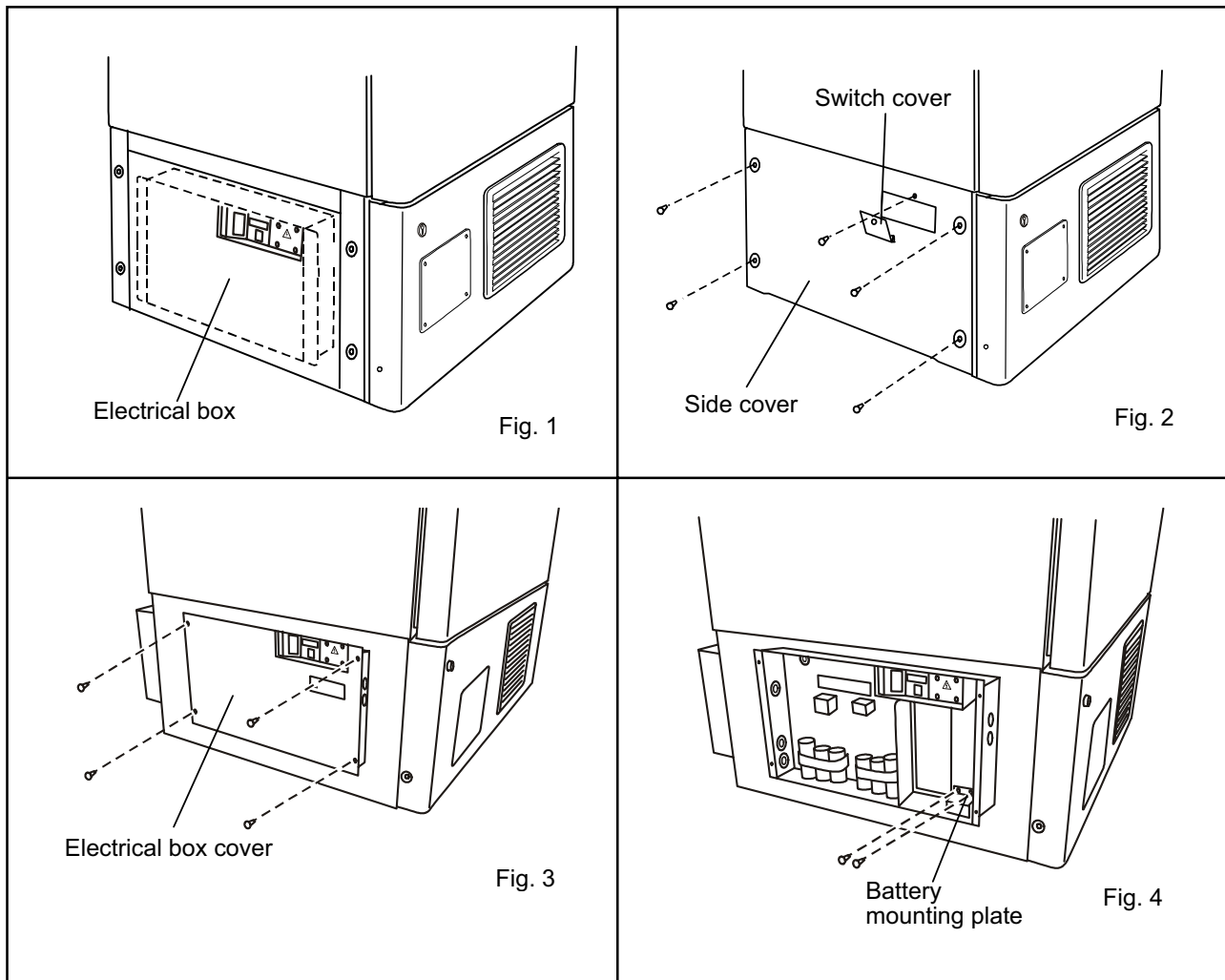

DISPOSAL OF UNIT

WARNING

If the unit is to be stored unused in an unsupervised area for an extended period **ensure that children do not have access and doors cannot be closed completely.**

The disposal of the unit should be accomplished by appropriate personnel. Always remove doors to prevent accidents such as suffocation.

Recycle of battery



The unit contains a rechargeable battery. The battery is recyclable. At the end of its useful life, check with your local solid officials option or proper disposal.

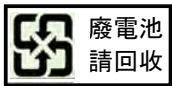

* Label indication is obliged to comply with Taiwanese battery regulation.

DISPOSAL OF UNIT

Note:

This symbol mark and recycle system are applied only to EU countries and not applied to the countries in the other area of the world.

Waste Electrical and Electronic Equipment (WEEE) Directive-2002/96/EC

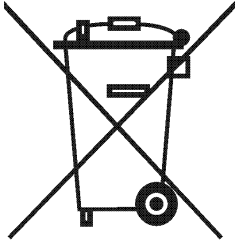

(English)

Your SANYO product is designed and manufactured with high quality materials and components which can be recycled and reused.

This symbol means that electrical and electronic equipment, at their end-of-life, should be disposed of separately from your household waste.

Please dispose of this equipment at your local community waste collection/recycling centre.

In the European Union there are separate collection systems for used electrical and electronic products.

Please help us to conserve the environment we live in!

(German)

Ihr SANYO Produkt wurde entworfen und hergestellt mit qualitativ hochwertigen Materialien und Komponenten, die recycelt und wiederverwendet werden können.

Dieses Symbol bedeutet, daß elektrische und elektronische Geräte am Ende ihrer Nutzungsdauer von Hausmüll getrennt entsorgt werden sollen.

Bitte entsorgen Sie dieses Gerät bei Ihrer örtlichen kommunalen Sammelstelle oder im Recycling Centre.

In der Europäischen Union gibt es unterschiedliche Sammelsysteme für Elektrik- und Elektronikgeräte.

Helfen Sie uns bitte, die Umwelt zu erhalten, in der wir leben!

DISPOSAL OF UNIT

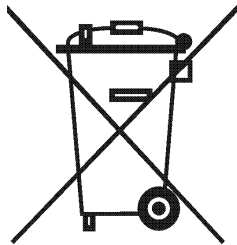

(French)

Votre produit Sanyo est conçu et fabriqué avec des matériels et des composants de qualité supérieure qui peuvent être recyclés et réutilisés.

Ce symbole signifie que les équipements électriques et électroniques en fin de vie doivent être éliminés séparément des ordures ménagères.

Nous vous prions donc de confier cet équipement à votre centre local de collecte/recyclage.

Dans l'Union Européenne, il existe des systèmes sélectifs de collecte pour les produits électriques et électroniques usagés.

Aidez-nous à conserver l'environnement dans lequel nous vivons !

Les machines ou appareils électriques et électroniques contiennent fréquemment des matières qui, si elles sont traitées ou éliminées de manière inappropriée, peuvent s'avérer potentiellement dangereuses pour la santé humaine et pour l'environnement.

Cependant, ces matières sont nécessaires au bon fonctionnement de votre appareil ou de votre machine. Pour cette raison, il vous est demandé de ne pas vous débarrasser de votre appareil ou machine usagé avec vos ordures ménagères.

(Spanish)

Los productos SANYO están diseñados y fabricados con materiales y componentes de alta calidad, que pueden ser reciclados y reutilizados.

Este símbolo significa que el equipo eléctrico y electrónico, al final de su ciclo de vida, no se debe desechar con el resto de residuos domésticos.

Por favor, deposite su viejo "televisor" en el punto de recogida de residuos o contacte con su administración local.

En la Unión Europea existen sistemas de recogida específicos para residuos de aparatos eléctricos y electrónicos.

Por favor, ayúdenos a conservar el medio ambiente!

DISPOSAL OF UNIT

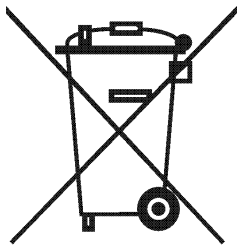

(Portuguese)

O seu produto SANYO foi concebido e produzido com materiais e componentes de alta qualidade que podem ser reciclados e reutilizados.

Este símbolo significa que o equipamento eléctrico e electrónico no final da sua vida útil deverá ser descartado separadamente do seu lixo doméstico.

Por favor, entregue este equipamento no seu ponto local de recolha/reciclagem.

Na União Europeia existem sistemas de recolha separados para produtos eléctricos e electrónicos usados.

Por favor, ajude-nos a conservar o ambiente em que vivemos!

(Italian)

Il vostro prodotto SANYO è stato costruito da materiali e componenti di alta qualità, che sono riutilizzabili o riciclabili.

Prodotti elettrici ed elettronici portando questo simbolo alla fine dell'uso devono essere smaltiti separatamente dai rifiuti casalinghi.

Vi preghiamo di smaltire questo apparecchio al deposito comunale.

Nell'Unione Europea esistono sistemi di raccolta differenziata per prodotti elettrici ed elettronici.

Aiutateci a conservare l'ambiente in cui viviamo!

DISPOSAL OF UNIT

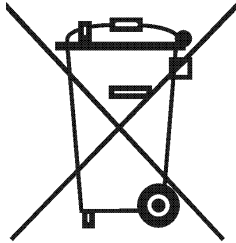

(Dutch)

Sanyo producten zijn ontwikkeld en gefabriceerd uit eerste kwaliteit materialen, de onderdelen kunnen worden gerecycled en weer worden gebruikt.

Het symbool betekent dat de elektrische en elektronische onderdelen wanneer deze vernietigd gaan worden, dit separaat gebeurt van het normale huisafval.

Zorg ervoor dat het verwijderen van de apparatuur bij de lokaal erkende instanties gaat gebeuren. In de Europese Unie wordt de gebruikte elektrische en elektronische apparatuur bij de daarvoor wettelijke instanties aangeboden.

Alstublieft help allen mee om het milieu te beschermen.

(Swedish)

Din SANYO produkt är designad och tillverkad av material och komponenter med hög kvalitet som kan återvinnas och återanvändas.

Denna symbol betyder att elektriska och elektroniska produkter, efter slutanvändande, skall sorteras och lämnas separat från Ditt hushållsavfall.

Vänligen, lämna denna produkt hos Din lokala mottagningstation för avfall/återvinningsstation.

Inom den Europeiska Unionen finns det separata återvinningssystem för begagnade elektriska och elektroniska produkter.

Vänligen, hjälp oss att bevara miljön vi lever i!

TEMPERATURE RECORDER (OPTION)

An automatic temperature recorder is available for this freezer as the optional component. The type of the recorder is MTR-G85.

Following shows the attachment procedure.

1. Remove four screws on the front panel and take it off. By removing four screws, take off the left side panel. Then take off the cover for the recorder mounting space by removing four screws. (Fig. 1)

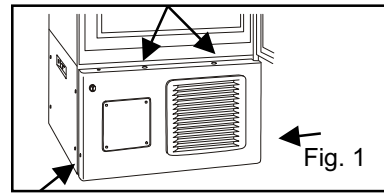

2. As shown in the Fig. 2, insert the temperature recorder to the mounting space and fix it to the back side of the front panel by using the recorder fixture enclosed with the recorder.

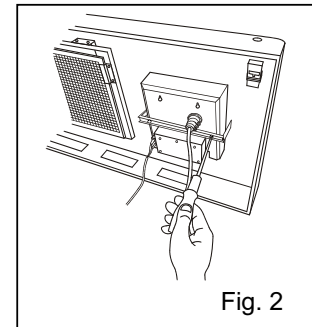
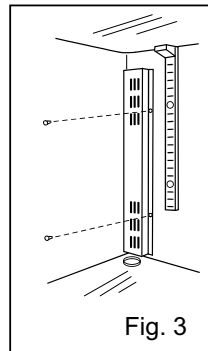

3. Take off the recorder sensor cover in the chamber (bottom left side) by removing two screws. Then remove the rubber cap and insulation covering the sensor port. (Fig. 3)

4. As shown in the Fig. 4, pass the recorder sensor through the sensor guide pipe from the front to the back. The sensor guide pipe is provided on the upper left side of the base compartment.

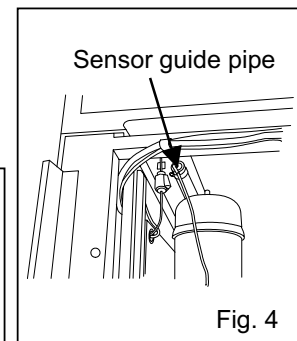
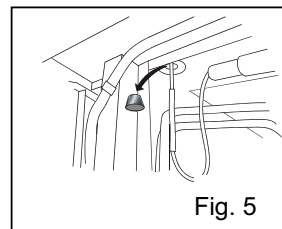

5. Take out the recorder sensor from the guide pipe at the back side and pass the sensor to the chamber through the access port. (Fig. 5)

6. Attach the recorder sensor on the sensor cover with the enclosed clips. Seal the sensor port with a silicon and replace the recorder sensor cover. Fix the cover to the inside wall. (Fig. 6)

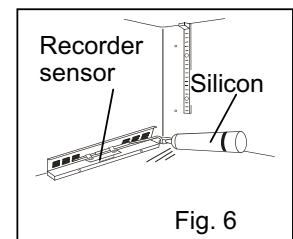
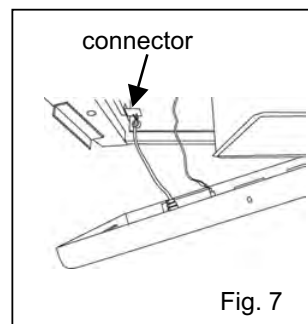

7. Remove the connector cover. Connect the recorder connector at the end of the power cord with the white connector on the left of the base compartment. Bind the extra lead wire of the sensor with a nylon clip on the back of the recorder. (Fig. 7)

8. Replace the left side panel and front panel and fix them with screws.

9. Operate the freezer until the chamber temperature gets to the set temperature. Check the recorded temperature and chamber temperature displayed on the control panel. Adjust the zero adjustment volume on the temperature recorder so that the recorded temperature can corresponds with the displayed temperature if they are not compliance each other

BACK-UP SYSTEM (OPTION)

WARNING

As with any equipment that uses CO₂ gas, there is a likelihood of oxygen depletion in the vicinity of the equipment. It is important that you assess the work site to ensure there is suitable and sufficient ventilation. If restricted ventilation is suspected, then other methods of ensuring a safe environment must be considered. These may include atmosphere monitoring and warning devices.

This freezer can be provided with a back-up system (CVK-UB2) which is available as an optional component. For the installation, refer to the instruction manual enclosed with the system.

1. Switch of back-up system (BACKUP)

When turning on the system, the lamp is brightened. This means that the system is ready. To stop the operation of the system, turn off this switch.

2. Test switch (TEST)

This switch is for checking the operation of back-up system. Pressing this switch is resulted in the release of liquid carbon dioxide without system operation.

3. Temperature setting knob (TEMP. SET)

With this knob, set the temperature at which the system is operated. The effective set temperature range is between -50°C and -70°C.

