

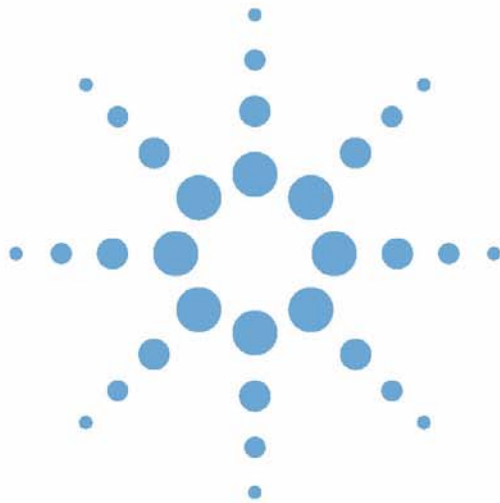

Agilent 1200 Series Evaporative Light Scattering Detector



User Manual



Agilent Technologies

Notices

© Agilent Technologies, Inc. 2008, 2009

Microsoft[®] is a U.S. registered trademark of Microsoft Corporation.

Parafilm[™] is a trademark of American National Can Co.

Teflon[™] is a trademark of E.I. Dupont de Nemours, Inc.

Tygon[™] is a trademark of the Norton Corporation

No part of this manual may be reproduced in any form or by any means (including electronic storage and retrieval or translation into a foreign language) without prior agreement and written consent from Agilent Technologies, Inc. as governed by United States and international copyright laws.

Manual Part Number

G4218-90001

This product is intended for research use only. Not for use in diagnostic procedures.

Edition

12/2009

Printed in Germany

Agilent Technologies, Inc.
Hewlett-Packard-Strasse 8
76337 Waldbronn

Research Use Only

Not for use in Diagnostic Procedures.

Warranty

The material contained in this document is provided “as is,” and is subject to being changed, without notice, in future editions. Further, to the maximum extent permitted by applicable law, Agilent disclaims all warranties, either express or implied, with regard to this manual and any information contained herein, including but not limited to the implied warranties of merchantability and fitness for a particular purpose. Agilent shall not be liable for errors or for incidental or consequential damages in connection with the furnishing, use, or performance of this document or of any information contained herein. Should Agilent and the user have a separate written agreement with warranty terms covering the material in this document that conflict with these terms, the warranty terms in the separate agreement shall control.

Technology Licenses

The hardware and/or software described in this document are furnished under a license and may be used or copied only in accordance with the terms of such license.

Restricted Rights Legend

If software is for use in the performance of a U.S. Government prime contract or subcontract, Software is delivered and licensed as “Commercial computer software” as defined in DFAR 252.227-7014 (June 1995), or as a “commercial item” as defined in FAR 2.101(a) or as “Restricted computer software” as defined in FAR 52.227-19 (June 1987) or any equivalent agency regulation or contract clause. Use, duplication or disclosure of Software is subject to Agilent Technologies’ standard commercial license terms, and non-DOD Departments and Agencies of the U.S. Government will receive no greater than Restricted Rights as

defined in FAR 52.227-19(c)(1-2) (June 1987). U.S. Government users will receive no greater than Limited Rights as defined in FAR 52.227-14 (June 1987) or DFAR 252.227-7015 (b)(2) (November 1995), as applicable in any technical data.

Safety Notices

CAUTION

A **CAUTION** notice denotes a hazard. It calls attention to an operating procedure, practice, or the like that, if not correctly performed or adhered to, could result in damage to the product or loss of important data. Do not proceed beyond a **CAUTION** notice until the indicated conditions are fully understood and met.

WARNING

A **WARNING** notice denotes a hazard. It calls attention to an operating procedure, practice, or the like that, if not correctly performed or adhered to, could result in personal injury or death. Do not proceed beyond a **WARNING** notice until the indicated conditions are fully understood and met.

In This Guide...

This manual is designed to describe the installation; operation, maintenance and basic troubleshooting of the G4218A Agilent Evaporative Light Scattering Detector. It includes:

1 Introduction

2 Site Requirements and Specifications

Site requirements and specifications of the Agilent 1200 Series Evaporative Light Scattering Detector

3 Installing the Detector

Installation of the detector.

4 Using the System

This chapter describes how to operate the Low Temperature Evaporative Light Scattering Detector. It includes information about starting the unit on a routine basis, collecting data and shutting down the unit.

5 Optimizing Performance

This chapter shows how to optimize the detector to achieve best results.

6 Troubleshooting and Diagnostics

This chapter describes a series of activities that should be performed on a periodic basis to ensure maximum performance. In addition, this chapter includes a protocol that can be used to determine the cause of problems that are observed with the instrument.

7 Maintenance

Introduction to maintenance and repair, instructions on simple, routine repair procedures

8 Parts for Repair

Detailed illustrations and lists for identification of parts and materials for repair

9 The Control Panel

This chapter describes the role of the various controls and displays on the detector.

10 Appendix

This chapter contains safety information.

Contents

1	Introduction	9
	The Low Temperature Evaporative Light Scattering Detector	10
	Principle of Operation	12
	Nebulization	14
	Evaporation of the Solvent	17
	Detection	17
2	Site Requirements and Specifications	19
	Site Requirements	20
	Power Considerations	20
	Gas Considerations	21
	Power Cords	21
	Exhaust venting and drain requirements	22
	Location of the Detector in the Laboratory	23
	Environment	23
	Specifications	24
3	Installing the Detector	27
	Lifting and Carrying the Module	28
	Unpacking the System	30
	Installing the Detector	32
	Gas Supply	33
	Vent the Exhaust Line to a Fume Hood	37
	Electrical Connections	38
	Additional Options	40

Contents

Installing the Nebulizer and Nebulization Chamber Assembly	43
Connecting the Siphon Overflow	46
Connecting the Nebulization Gas to the Nebulizer	47
Connecting the Column	47
Powering Up the Unit	47
4 Using the System	49
Preparing the System for Operation	50
Auto-zeroing the Detector	51
Manual Auto-zeroing of the Detector	51
External Auto-zeroing of the Detector	51
Routine Operation of the System	52
Installation Test Procedure	54
Powering Down and Shutting Down the System	56
5 Optimizing Performance	59
Selecting the Optimum Temperature	60
Optimizing the Mobile Phase	62
Sample Pre-Treatment	62
Column Treatment	63
Optimizing the Filter	64
6 Troubleshooting and Diagnostics	65
Basics of Troubleshooting	66
Initial Troubleshooting Activities	67
If there is no response from the system	68
Perform the Noise Tests	69
Specific Detector Troubleshooting	70
Noise test procedures	71
Preliminary Activities	72

Electronic Noise Test	73
Background Noise (Stray Light) Test	74
Solvent Noise Test	75
Column Noise Test	77
Troubleshooting based on diagnostic tests	78
Electronic noise test	78
Stray light test	78
Failed run of standard sample	78
Troubleshooting based on instrument signals	79
No signal is observed	79
Decrease in sensitivity	80
A noisy signal is observed	80
7 Maintenance	81
General inspection	82
Cleaning and Decontamination	83
Cleaning the Detector	83
Decontaminating the detector	83
Removing the nebulization chamber and nebulizer	84
Cleaning the Nebulizer	86
Adjusting stray light settings	89
8 Parts for Repair	91
Evaporative Light Scattering Detector Parts	92
9 The Control Panel	95
The Control Panel	96
The Digital Display	97
The User Interface	98

Contents

10	Appendix	107
	Safety Information	108
	Solvent Information	112
	The Waste Electrical and Electronic Equipment (WEEE) Directive (2002/96/EC)	113
	Lithium Batteries Information	114
	Agilent Technologies on Internet	115
	Index	117

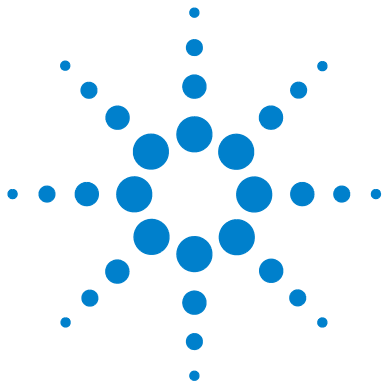

1 Introduction

The Low Temperature Evaporative Light Scattering Detector 10
Principle of Operation 12

1 Introduction

The Low Temperature Evaporative Light Scattering Detector

The Low Temperature Evaporative Light Scattering Detector

The Agilent 1200 Series Evaporative Light Scattering Detector (Figure 1) is designed to detect compounds in the eluent from high performance liquid chromatography (HPLC), micro-HPLC, gel permeation chromatography (GPC) or counter current chromatography (CCC). It is capable of monitoring eluent flow rates from 5 $\mu\text{l}/\text{min}$ to 5 ml/min . Evaporative light scattering detection is a universal technique which can detect any non-volatile analyte. Detection does not depend on the absorption of radiation and is not affected by the absorption characteristics of the solvent; thus solvents which absorb UV radiation can be used.



Figure 1 The Agilent 1200 Series Evaporative Light Scattering Detector

The Low Temperature Evaporative Light Scattering Detector

The detector is controlled via the keypad and digital display on the front panel. Alternatively, the system can be controlled by an external computer using the RS-232 port. The output can be sent to a recorder or data station. The detector includes a nebulizer, evaporation tube and detector head. The evaporation tube is located in an oven to assist in the evaporation of the solvent.

Principle of Operation

There are three steps in the operation of the detector:

- 1 nebulization of the eluent,
- 2 evaporation of the solvent and
- 3 detection of the compound(s) of interest ([Figure 2](#)).



Figure 2 Schematic Diagram of an Evaporative Light Scattering Detector

Nebulization involves the conversion of the eluent into a fine mist. The mist is passed through an evaporator to vaporize solvent. In the detector unit, the mist is irradiated by a light source and scattered light is measured by a photomultiplier (PM). The degree of light scattering is related to the concentration of the compound of interest in the sample. A cross sectional view of the system is presented in [Figure 3](#).

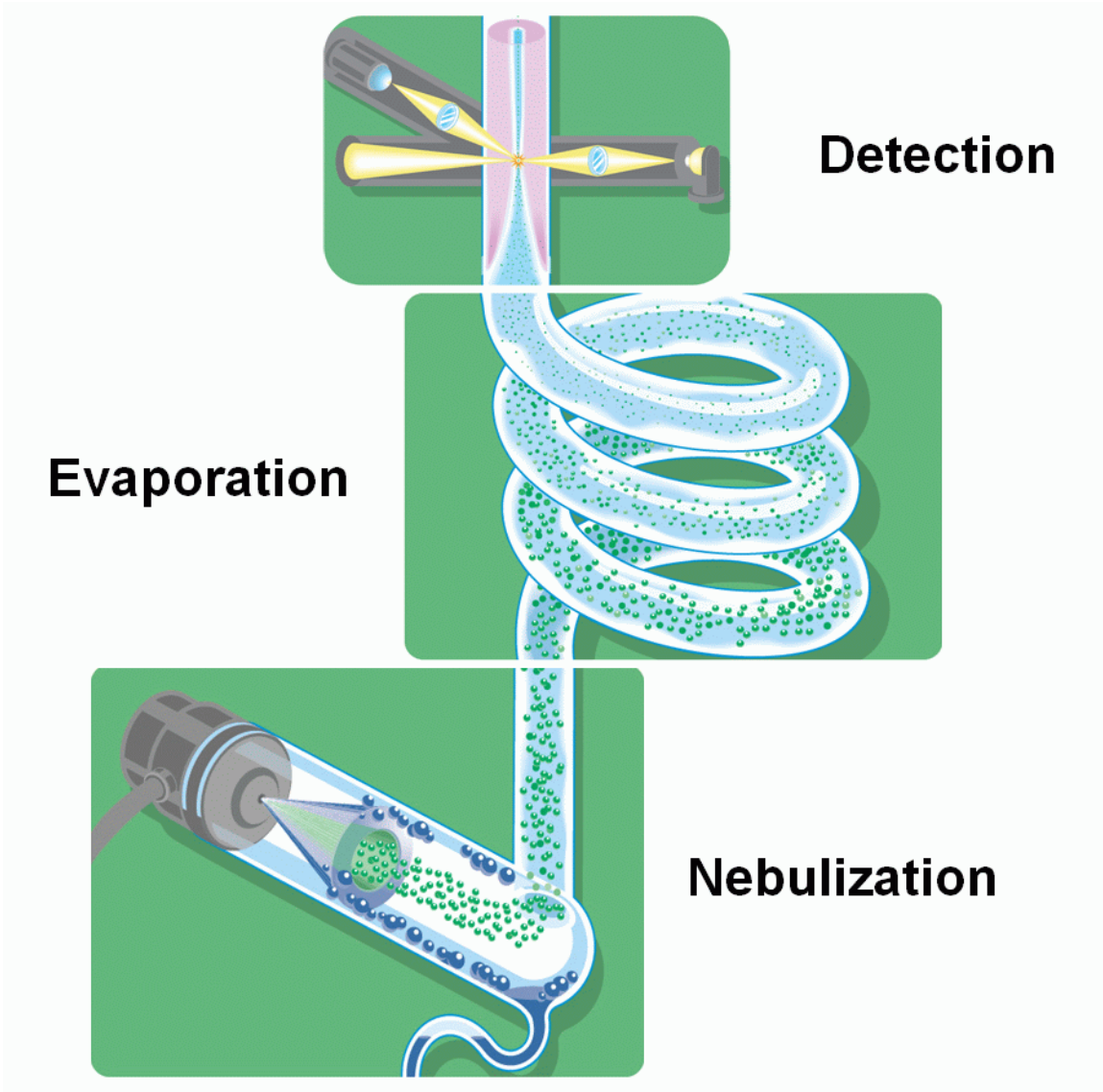

Figure 3 Schematic display of principle measurement steps in the ELSD of the Detector

Nebulization

The eluent from the chromatograph is nebulized by the inlet gas (typically nitrogen). At the outlet of the nebulizer, the aerosol travels through a chamber. Large droplets in the aerosol go to a siphon while the fine mist moves to the evaporation tube. The overall design of the nebulizer is shown in [Figure 1](#) and the nebulization chamber is shown in [Figure 5](#).

Five different nebulizers are available for optimizing the performance of the detector at different HPLC flow rates (see [Table 9](#)). The user should select the nebulizer to best match the flow rate that will be used with the separation when the detector is ordered (the optimal range for each nebulizer is indicated in [Table 9](#)). Additional nebulizers are available from Agilent Technologies and can be easily installed, see “[Installing the Nebulizer and Nebulization Chamber Assembly](#)” on page 43.

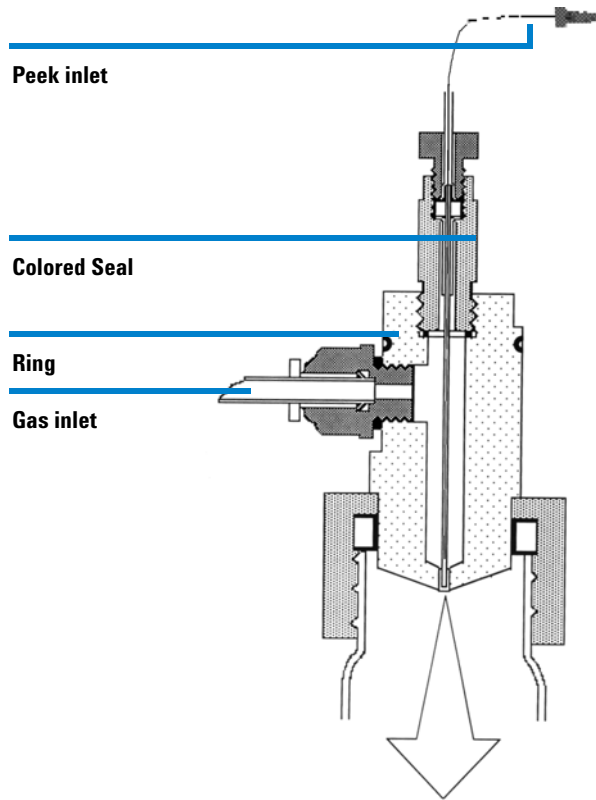

Figure 4 Design of the Nebulizer

1 Introduction
Principle of Operation

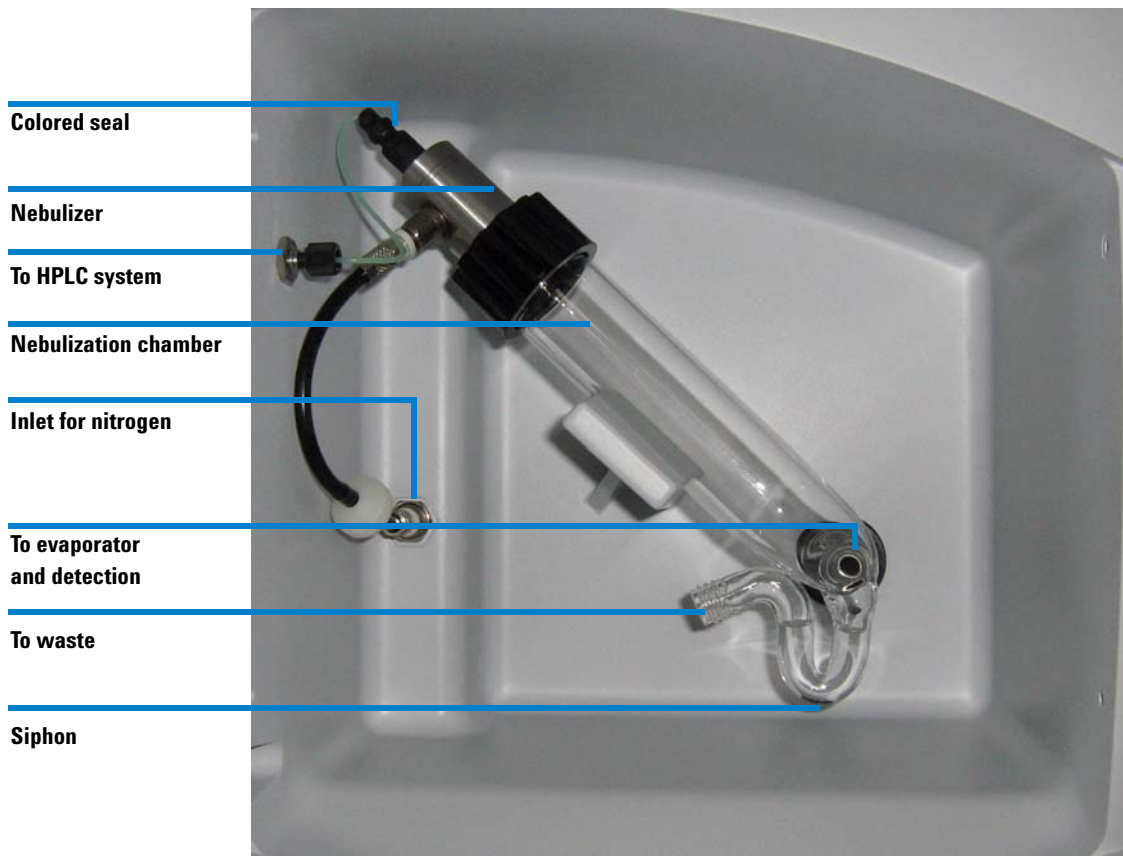

Figure 5 The Nebulizer

Evaporation of the Solvent

A heated tube is used to evaporate the solvent. The exit of the heated tube leads directly into the detector cell.

In liquid chromatography, water and organic solvents with low boiling points are typically employed (e.g. methanol, acetonitrile). A typical mobile phase for a reverse phase separation using evaporative light scattering detection might be methanol/water (60/40) while a typical mobile phase for normal phase separation might be hexane.

If acids, bases and salts are used to modify mobile phase to provide the desired separation, they should be able to be readily evaporated, sublimed or decomposed into gases in the evaporation tube. Mobile phase modifiers that are commonly used when an evaporative light scattering detector is employed include NH_4OH , $(\text{C}_2\text{H}_5)_3\text{N}$, NH_4OAc , HCOOH , CH_3COOH , CF_3COOH and HNO_3 .

Detection

The carrier gas transports the microparticles from the heating tube into the detection chamber (Figure 6).

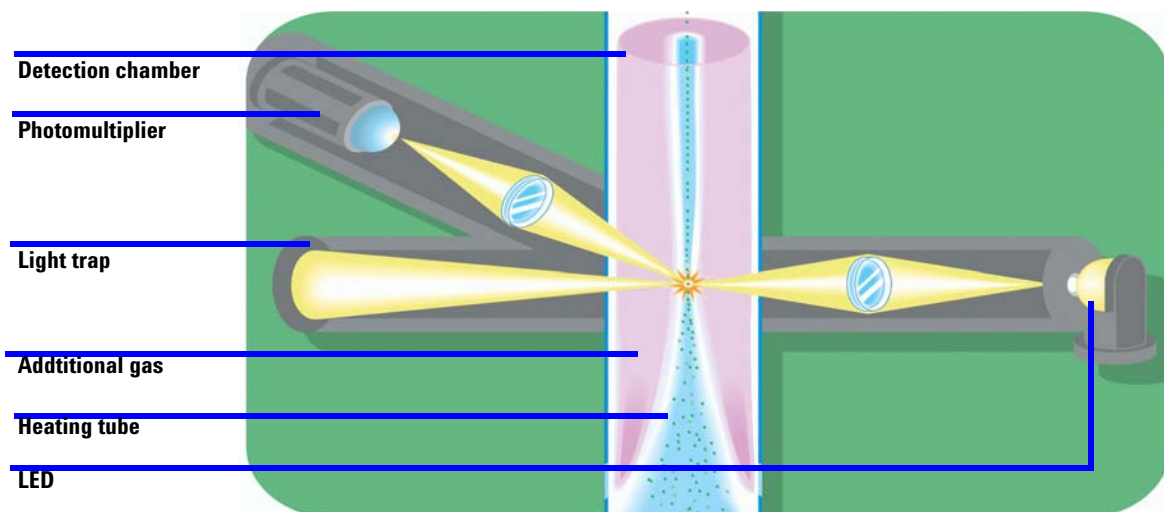

Figure 6 The Detection Chamber

1 Introduction

Principle of Operation

The detector chamber contains a light emitting diode (LED) and a photomultiplier that is positioned at an angle of 120° with respect to the light beam (Figure 6). When the carrier gas contains microparticles, the light is scattered and is detected by the photomultiplier.

The intensity of the scattered light is a function of the mass of the scattering particles and generally follows an exponential relationship, which is shown in Equation 1.

$$I = k m^b \quad (1)$$

where:

I is the intensity of light

m is the mass of the scattering particles

k and **b** are constants

A plot of log I versus log m provides a linear response. The values of the constants (k and b) depend on a variety of experimental conditions (e.g. the temperature and the nature of the mobile phase).

A gas inlet before the detector chamber provides a concentric shield for the carrier gas. This serves to eliminate diffusion of the carrier gas and eliminates contamination of the detector cell.



2 Site Requirements and Specifications

Site Requirements	20
Specifications	24

Site Requirements

A suitable environment is important to ensure optimum performance of the Agilent 1200 Series detector.

Power Considerations

The detector is configured for either 100 V AC / 50-60 Hz, 115 V AC / 60 Hz or 230 V AC / 50 Hz input power depending on the country to which it is shipped. Ensure that the voltage value indicated on the power connector on the rear panel corresponds to the line voltage in your facility.

The detector requires G4218-64000 230 V, 1.7 A, 400 W, 50 Hz, G4218-6410 115 V, 1.8 A, 210 W, 60 Hz, G4218-64020 100 V, 2.1 A, 210 W, 50/60 Hz. Check that the power lines can provide sufficient current.

The detector must be connected to a properly grounded three prong plug to ensure proper operation of the system. If a two prong outlet is used, make sure that the ground wire is used to ground the instrument. It is recommended that all components of the HPLC system are connected to a common ground.

The detector should not be connected to an electrical line which also serves units with a large power drain or which may be subject to power surges. Such units include refrigerators, ovens, centrifuges and fume hoods.

WARNING

Incorrect line voltage at the instrument

Shock hazard or damage of your instrumentation can result, if the devices are connected to a line voltage higher than specified.

⇒ Connect your instrument to the specified line voltage.

Gas Considerations

A supply of clean, filtered, oil free inert clean gas (typically nitrogen) is required to operate the detector. The gas supply needs to be free of particles, as particles will create background noise in the chromatograms. In case of such noise for example for newly installed gas lines, flush the gas lines for sufficient time (might take days) and consider additional filters. Pure gas is not required as the gas is only used as a carrier for the solid sample particles.

CAUTION

Damage of pressure sensor

Pressures above 4.5 bar (67 psi) can damage the pressure sensor of the detector. The gas consumption for the large nebulizer is 4 l/min and 3 l/min for all other nebulizers. The target pressure for most applications is 3.5 bar (51 psi).

=> Do not switch on the gas flow suddenly, as this may cause the exceeding of maximum pressure. The use of a separate pressure regulator is highly recommended. A filter (0.01 µm) and manometer (part number G4218-60100) is available as an option. Replacement filter cartridges are available as part number G4218-40150.

Power Cords

Your detector is delivered with a power cord which matches the wall socket of your particular country or region. The plug on the power cord which connects to the rear of the instrument is identical for all types of power cord.

WARNING

Electric Shock

The absence of ground connection and the use of an unspecified power cord can lead to electric shock or short circuit.

=> Never operate your instrumentation from a power outlet that has no ground connection.

=> Never use a power cord other than the power cord designed for your region

WARNING

Use of unsupplied cables

The use of cables which haven't been supplied by Agilent Technologies can lead to damage of the electronic components or personal injury.

=> Never use cables other than the ones supplied by Agilent Technologies to ensure proper functionality and compliance with safety or EMC regulations.

Exhaust venting and drain requirements

The exhaust from the detector must be directed into a fume hood or exhaust vent. If a vacuum is used, it should be moderate so as to avoid turbulence in the glass cell siphon. The potentially hazardous exhaust of evaporated solvent and sample must not be allowed to enter the laboratory atmosphere and any appropriate accessory like solvent filters should be disposed according to local environmental requirements.

The drain tube must be directed to a suitable solvent. The user is responsible for decontamination or recycling of any residue, regarding to local environmental requirements.

CAUTION

Toxic and hazardous vapors

Exhausts could cause personal injury or laboratory pollution.

=> Make sure the instrument is installed and the exhaust is vented according to local regulatory authorities for health and safety requirements.

Location of the Detector in the Laboratory

All components of the system (e.g. HPLC pumps, detector) should be located on a robust table. The detector should be placed in an area that is free from drafts or significant temperature changes. Do not place it near air conditioning vents, windows, ovens, etc.

When placing the detector in the laboratory, access to the power to disconnect the device (the appliance coupler or the mains plug) must be kept accessible at all time.

The detector should be placed close to the outlet of the column to minimize extra-column band broadening which will reduce the resolution of the chromatogram.

Environment

This instrument has been designed for following conditions:

- Use inside buildings
- Altitude up to 2000 meters
- Ambient temperature from 5°C to 40°C
- Maximum humidity of 80% for temperatures under 31°C, with linear decrease to 50% at 40°C
- Maximum variations for main power voltage: 10% from nominal voltage.
- Transitory overvoltage of class II
- Pollution degree: 2

Specifications

Table 1 Specifications ELSD

Detection	High Sensitivity Photomultiplier
Light Source	Selected High Efficiency Blue LED
Temperature Range	Ambient to 100 °C
Gas Flow Control	Manual and computer controlled nebulization gas flow and auxiliary gas flow.
Gas Consumption	Less than 4 l/min for the Large Flow Nebulizer, less than 3 l/min for all other nebulizers.
Gas pressure	3.5 bar (51 psi) typical, min. 3 bar (44 psi) to max. 4.5 bar (67 psi)
Eluent Flow Rate	Micro Flow Nebulizer: 5 µl/min to 50 µl/min
	Semi Micro Flow Nebulizer: 40 µl/min to 1 ml/min
	Standard Flow Nebulizer: 500 µl/min to 2 ml/min
	Large Flow Nebulizer: 1.5 to 5 ml/min
	Rapid Resolution Nebulizer: 0.2 to 1.4 ml/min
Instrument Control	Microprocessor with stand alone manual keypad or Windows based PC control (see specifications for your instrument control software)
Operating Parameters Control	Liquid Crystal Digital Panel
Signal Drift*	Less than 1 mV/h
Signal Noise*	< ± 1 mV
Signal Output	0-1000 mV (Analog)
	RS-232 (Digital)
Inputs	Remote Autozero (Contact Closure or TTL Signal)
	Remote Powerdown Mode (Contact Closure or TTL Signal)

Table 1 Specifications ELSD

Power Down Mode	General, Standby, Cleaning
Zero Control	Manual Auto Zero and Remote Auto Zero
Interface	RS-232 I/O Serial Output
Power	100 V / 2.1 A, 115 V/60 Hz, 1.8 A or 230V/50 Hz, 1.7 A
Dimensions	250 mm (10") W x 450 mm (18") H x 550mm (22") D
Weight	18.5 kg (40 lb.)

* Conditions for drift and noise:
 Eluent Flow: 0 ml/min
 Evaporator Temperature: 50 °C
 Nebulizer Gas: Nitrogen, pressure 3.5 bar
 Gain: 12
 Noise: measured as mean value for 10 segments of 1 minute. For each segment the difference of the highest minus the lowest peak is calculated and divided by 2.

2 Site Requirements and Specifications

Specifications

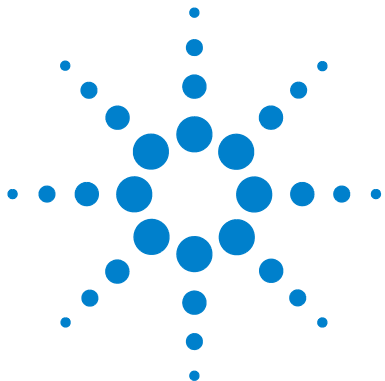

3 Installing the Detector

Lifting and Carrying the Module	28
Unpacking the System	30
Installing the Detector	32
Electrical Connections	38
Additional Options	40
Installing the Nebulizer and Nebulization Chamber Assembly	43

This chapter describes how the laboratory should be prepared to optimize the performance of the Agilent 1200 Series Evaporative Light Scattering Detector and indicates how the unit is interfaced to other devices such as the column and the data recording device. When you have successfully installed the unit, refer to [Chapter 4](#) for start-up procedures.



Lifting and Carrying the Module

CAUTION

Safe transport

Module is heavy

=> To ensure safe transport and avoid bodily injury, make sure that the module is lifted by two persons.

Once the module is unpacked, ensure that no cables or tubing are connected when you carry the module. The module should be lifted by the bottom (e.g. place your hands under the module). Two persons are needed to ensure easy transport and avoid bodily injury ([Figure 7](#)).



Figure 7 Carrying the System

Unpacking the System

CAUTION

"Defective on arrival" problems

If there are signs of damage, please do not attempt to install the module. Inspection by Agilent is required to evaluate if the instrument is in good condition or damaged.

=> Notify your Agilent sales and service office about the damage

=> An Agilent service representative will inspect the instrument at your site and initiate appropriate actions.

=> It is recommended that the shipping carton be retained as it can be used if it should become necessary to transport the system.

Table 2 Components Shipped with the Agilent 1200 Series Evaporative Light Scattering Detector

Quantity	Part Number	Description
1	G4218-20000	Standard Flow Nebulizer
1	G4218-40000	Nebulization chamber, glass
1	G4218-90000	Operator's Manual
1	G4218-85000	Caffeine Standard 250 µg/ml in water
1	G4218-6800x	Accessory Kit consists of: 1 Power cable 1 Auto-zero cable 1 Signal cable 1 RS-232 cable 1 External event cable 6 mm O.D. gas tubing (2 meters + 1 meter sets) 1 set of replacement fuses 1 Drain tube, including seal Ferrule and fitting
1	G1946-60111	Drain bottle assembly
1	G1312-67305	Capillary, 600 x 0.17 mm

Table 2 Components Shipped with the Agilent 1200 Series Evaporative Light Scattering Detector

Quantity	Part Number	Description
1 (500 cm)	0890-1727	Tubing 5m
1	5061-3378	Cable, remote (APG)
1 (optional)	G4218-60100	Gas regulator with filter 0.01 µm and manometer
1 (optional)	see Table 9	Nebulizer

Agilent Technologies provides a wide range of accessories (e.g. Gas Regulator with Filter and Manometer (part number G4218-60100) to support the operation of the detector. A complete listing of all spare parts and accessories is included as [Chapter 8](#).

Damaged Packaging

Upon receipt of your detector, inspect the shipping containers for any signs of damage. If the containers or cushioning material are damaged, save them until the contents have been checked for completeness and the detector has been checked mechanically and electrically. If the shipping container or cushioning material is damaged, notify the carrier and save the shipping material for the carriers inspection.

Delivery Checklist

Ensure all parts and materials have been delivered with the detector. The instrument box contains the instrument and an Accessory kit. A separate box contains the reference manual and the power cable.

[Table 2](#) on page 30 lists the content of each accessory kit.

Please report missing or damaged parts to your local Agilent Technologies sales and service office.

Installing the Detector

CAUTION

„Defective on arrival problems“

If there are signs of damage to the autosampler, please do not attempt to install the detector. Inspection by Agilent is required to evaluate if the instrument is in good condition or damaged.

=> Notify your Agilent sales and service office about the damage.

=> An Agilent service representative will inspect the instrument at your site and initiate appropriate actions.

=> It is recommended that the shipping carton be retained as it can be used if it should become necessary to transport the system.

Table 3 Parts required:

Quantity	Part Number	Description
1	See Table 9	Nebulizer
1	G4218-40000	Nebulization chamber, glass
1	G4218-90000	Operator's Manual
1	G4218-6800x	Accessory Kit consists of: 1 Power cable 1 Auto-zero cable 1 Signal cable 1 RS-232 cable 1 External event cable 6 mm O.D. gas tubing (2 meters + 1 meter sets) 1 set of replacement fuses

Gas Supply

The unit is connected to the gas supply via the 6 mm plastic tubing (supplied) using the fitting on the upper left corner of the supply panel on the back of the detector (Figure 7)

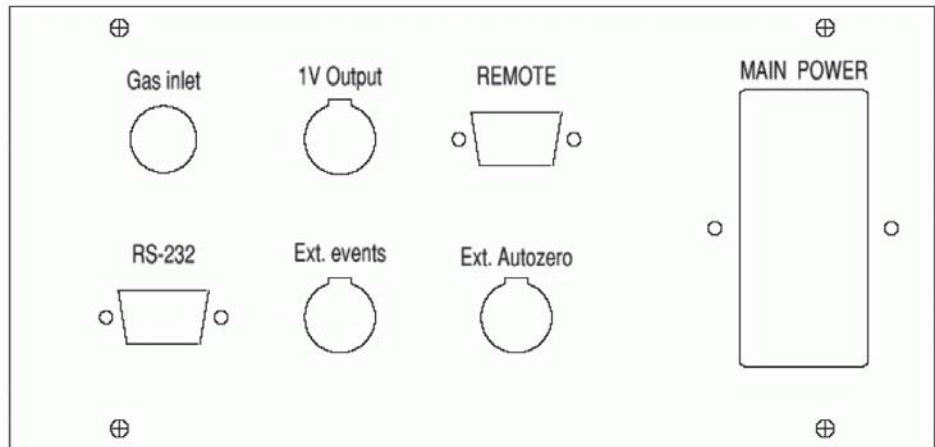

Figure 8 Supply Panel

3 Installing the Detector

Installing the Detector

Inserting the gas inlet tube

NOTE

Ensure that Parafilm™ is removed from exhaust tube and drain tubing before installing unit.

- 1 The tubing should be cut and firmly inserted into the fitting as shown, after removing Parafilm™ from detector gas inlet.

- 2 Cut the tube square.

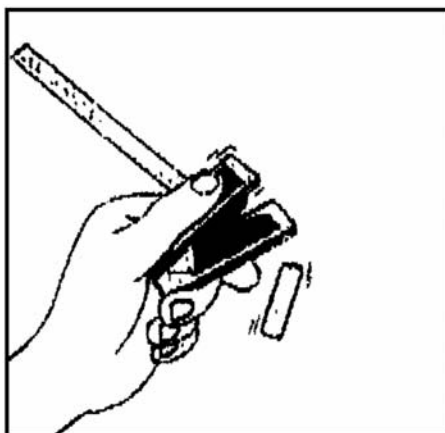

- 3 Insert the tube into the fitting until it bottoms.

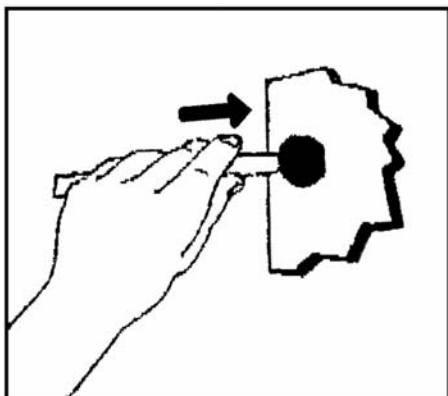

- 4 Pull the tube to check engagement of the grab.

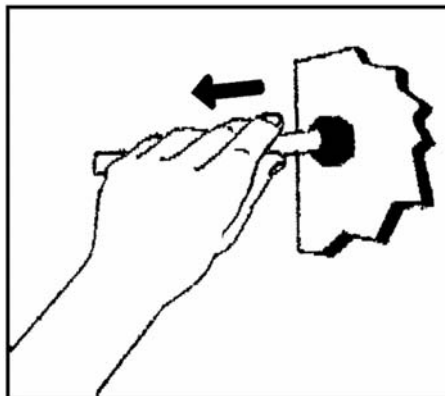

WARNING

Tube damage or inappropriate installation

Health risk due to gas leakage.

=> Make sure that no tube damage or inappropriate installation could allow a gas leak in laboratory.

Two pieces of tubing are provided. If you are using the system with an external filter, connect the gas source to the filter and then connect the filter to the back of the unit. Make sure that no tube damage or inappropriate installation could allow a gas leak in laboratory.

3 Installing the Detector

Installing the Detector

Removing the Gas Inlet Tube

To remove the gas inlet tube (if necessary)

1 disengage the grab ring teeth by a simple manual pressure on the push sleeve and withdraw the tube from the fitting.

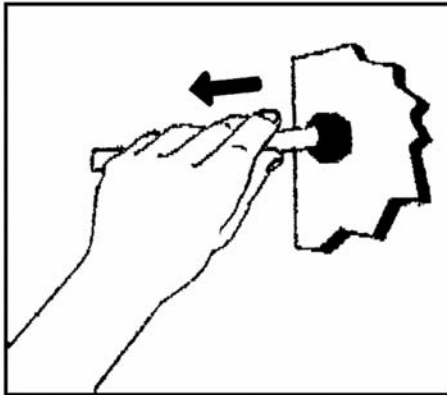

Vent the Exhaust Line to a Fume Hood

- 1 Vent the black exhaust tube on the back of the unit to a fume hood, exhaust line or similar installation.
- 2 Make sure that the fume hood withdraws gas from the detector (i.e. there should be a positive pressure between the detector and the hood).

WARNING

Danger of poisoning and fire hazard

The exhaust coming from the detector contains evaporated solvent and sample. Many HPLC solvents like acetonitrile or methanol are toxic and inflammable.

=> Verify that no tube damage or inappropriate installation could allow a gas leak in laboratory.

CAUTION

Contamination of detector

If gas from the hood enters the detector, it is possible that foreign material from the hood could contaminate the detector.

=> Avoid negative pressure between the detector and the fume hood.

- 3 Install the vent tube so that it cannot become blocked or bent

CAUTION

Bias of measurement results

Turbulences in the glass cell siphon, liquid spilled into the heating tube or contamination of the detector.

=> Make sure the negative pressure of hood or exhaust line is not too strong such that no air is drawn in from the leak drain.

- 4 The vacuum must be moderate to avoid turbulence in the glass cell siphon.
- 5 Using the drain bottle assembly G1946-60111 and included tubing is recommended as a condensation trap and for pressure compensation. Avoid long tube installations in upward direction creating condensation dropping back into the detector. Avoid loops or bends in the tubing which form condensation traps causing bad measurement results.

Electrical Connections

All electrical connections are made via the supply panel (Figure 8).

- 1 Use the RS-232 (serial) connection as a standard connection to a control PC with Agilent Chemstation control and data evaluation software. Different options are available for connections to third party devices, see Appendix 4.
- 2 Connect the detector to your personal computer via the RS-232 port using the cable supplied with the instrument. If you use a different cable make sure to use a straight RS-232 cable, which directly connects pins of same numbers. Most RS-232 cables are cross-over or null modem cables and cannot be used for this connection.
- 3 Connect the ELS detector to the APG remote control of your LC modules. Use the supplied cable (Cable remote 5061-3378) and plug it to the connectors labeled with "REMOTE". Not using the APG connection will impair the retention time reproducibility.
- 4 Place the ON/OFF switch to the OFF position and plug the power cord into the socket on the rear panel of the detector.

NOTE

Do **not** turn on the power at this time.

- 5 Connect the three wires of the power cord of this system to a grounded line. All components of the chromatographic system should be connected to a common ground. If a two wire outlet is used, make sure that an adapter is used to connect the third wire to ground.

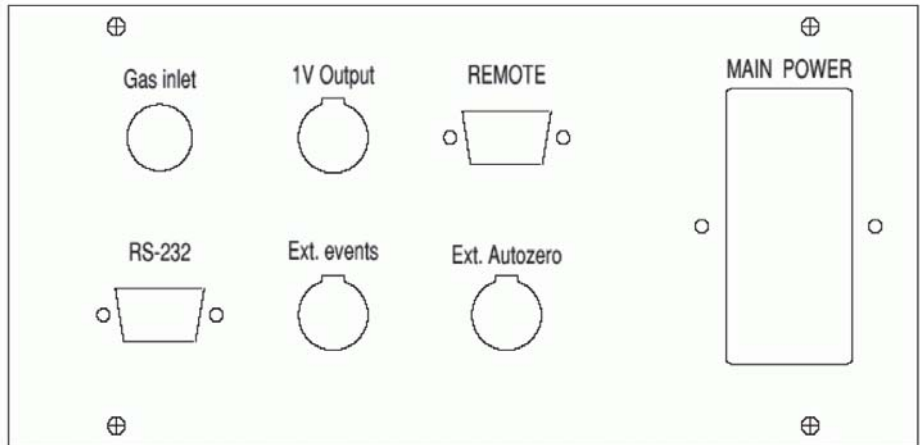

Figure 9 Supply panel

Additional Options

Use the RS 232 cable as a standard connection to a control PC with Agilent Chemstation control and data evaluation software.
All electrical connections are made via the supply panel (Figure 10).

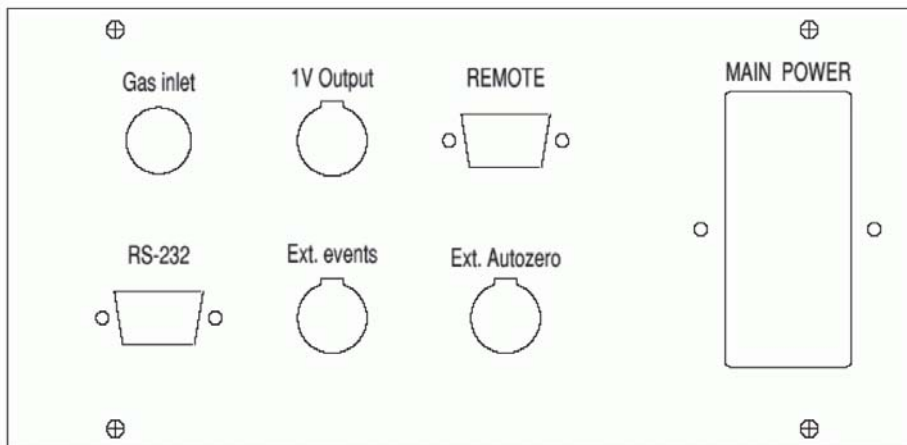

Figure 10 Supply Panel

Connecting the Recorder/Integrator

If a recorder or integrator is employed, connect the recorder input to the 1 V output terminal on the rear panel of the detector (Figure 10) and to the appropriate socket on the recorder/integrator.

Connecting the External Autozero

If the external autozero function shall be used, plug the cable that is supplied into the *Ext Autozero* socket on the detector (Figure 10) and to the appropriate socket on the controlling device

Use a contact closure or TTL signal for auto-zeroing the detector.

Do not install the autozero cable if not needed. An unintentional short circuit of the loose ends will result in a continuous zero signal.

If a TTL signal is used please make sure to use the correct polarity identified on the cable.

Refer to “[External Auto-zeroing of the Detector](#)” on page 51 to operate external autozero contact closure.

Connecting the External Events Cable

If the external events functions shall be used, plug the cable that is supplied into the appropriate socket on the rear panel of the detector ([Figure 10](#)) and to the appropriate socket on the controlling device.

The white cables are contact closure "output" cables that provide the ready/non-ready information to an external device. The detector will be in the "not-ready" mode (the contact will be in closed position) if any of the following conditions is observed:

- The lamp is off
- The temperature is not at the indicated setpoint
- The temperature is at the indicated setpoint but is not stable
- The pressure is below 3.0 bar

NOTE

The controlled device electrical consumption mustn't exceed 20 mA under 12 V DC.

The blue cables are contact closure "input" cables that are used to power the unit down (see “[The Gas Valve Screen](#)” on page 103) via a signal from an external device to the detector.

A contact closure signal must be used from the controlling device to short circuit the contacts. If a TTL signal is used please make sure to use the correct polarity identified on the cable.

- RS-232 Port

If a personal computer is used with the detector, the detector should be connected to the computer via the RS-232 port using the supplied cable.

3 Installing the Detector

Additional Options

Connecting the Power Cord

Place the ON/OFF switch to the OFF position and plug the power cord into the socket on the rear panel of the detector.

NOTE

Do not turn on the power at this time.

The power cord of this system contains three wires which must be connected to a grounded line. All components of the chromatographic system should be connected to a common ground. If a two wire outlet is used, make sure that an adapter is used to connect the third wire to ground.

Installing the Nebulizer and Nebulization Chamber Assembly

Parafilm™ is used to cover various openings inside the compartment, nebulizer and nebulization chamber to prevent dust particles from entering the system during shipment.

The installed Nebulizer/Nebulization chamber assembly is shown in [Figure 11](#).

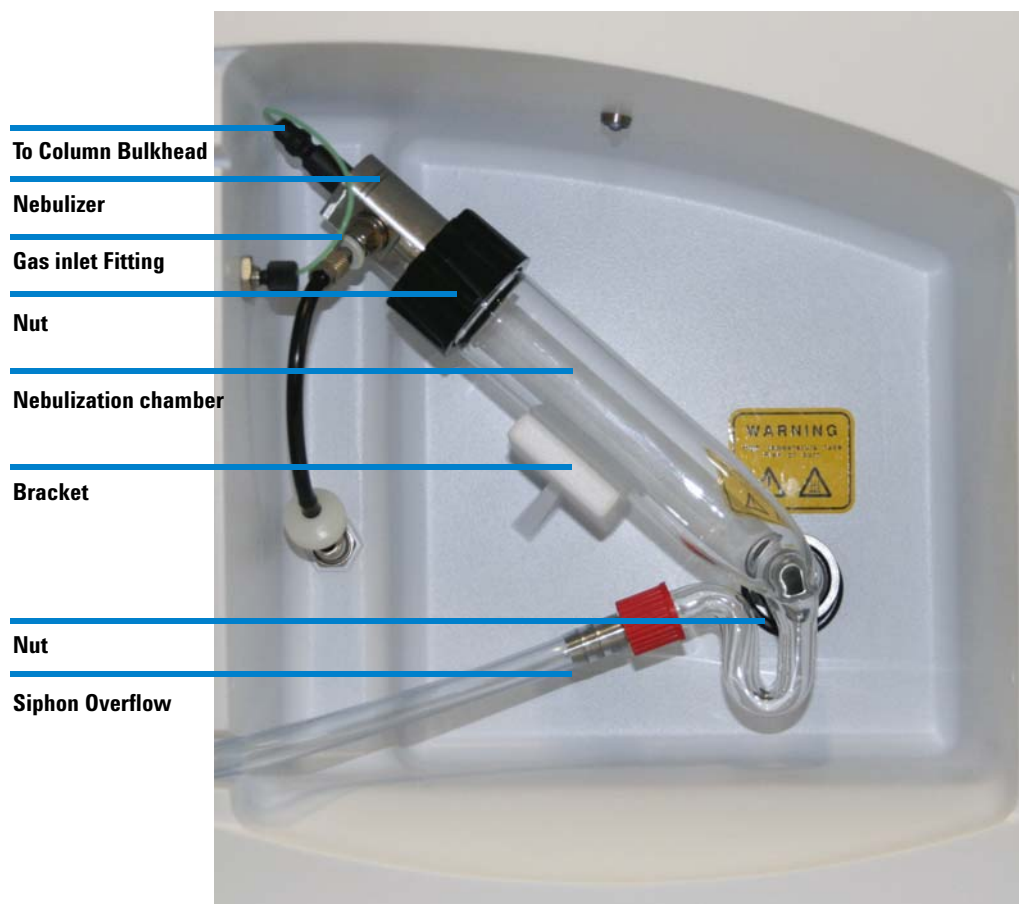

Figure 11 Installing the nebulizer/nebulization chamber assembly

3 Installing the Detector

Installing the Nebulizer and Nebulization Chamber Assembly

To install the assembly:

- 1 Remove the Parafilm™ on all detector openings and on the nebulizer cell (these coatings are used to prevent dust particles from entering the system during shipment).
- 2 Position the nebulization chamber as shown in [Figure 11](#) and tighten the black nut at the bottom. The nebulization chamber is in the correct position, if it is in contact with the back wall as shown in [Figure 12](#).



Figure 12 Fixing the Tip of Nebulization chamber

- 3 Use the large black nut to position the nebulizer on the nebulization chamber.
- 4 Screw the inlet fitting into the bulkhead on the left side of the compartment. Special care must be taken when positioning this fitting. The nebulizer is terminated with a small piece of Teflon tubing with an outer green sleeve. For proper operation, the Teflon tubing must extend less than 2 mm past the end of the green sleeve ([Figure 13](#)).

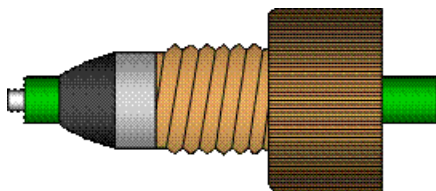

Figure 13 Nebulizer Inlet Fitting

WARNING***Health risk caused by liquid leaks***

Liquid leaks could cause personal injury or laboratory pollution or negatively affect the detector performances by pressed out liquid.

⇒ **Make shure that all connections are tight and that there is no liquid leak.**

- 5 Fill the siphon overflow on the nebulizer/glass tube assembly with the mobile phase that will be used for the separation. If you are using a highly volatile solvent like hexane or CH_2Cl_2 , use water to fill the overflow. The liquid should fill the bent part of the siphon, but should not pool in the bottom of the condenser tube.

Connecting the Siphon Overflow

- 1 Attach the Tygon™ drain tube assembly to the end of the siphon tube using the tapered hose connector and lead the tube to a waste container.
- 2 Locate the tube in such a way that condensed solvent can flow freely from the siphon and ensure that the end of the tube is not immersed in the collected liquid. Make sure that the liquid container is appropriate for the solvents used.
- 3 Ensure that no siphon liquid leak could affect detector performances or create a laboratory pollution.

If the solvent that you are using is not compatible with Tygon™ (e.g. THF), use instead a piece of Teflon tubing or any material that you know is compatible with your solvent.

WARNING

Toxic and hazardous solvents

The handling of solvents and reagents can hold health risks.

=> When opening capillary or tube fittings solvents may leak out.

=> Please observe appropriate safety procedures (for example, goggles, safety gloves and protective clothing) as described in the material handling and safety data sheet supplied by the solvent vendor, especially when toxic or hazardous solvents are used.

Connecting the Nebulization Gas to the Nebulizer

Attach the nebulization gas tube coming out of the front panel to the nebulizer gas inlet fitting located on the nebulizer side as shown in [Figure 11](#).

Connecting the Column

- 1 Attach the nebulization gas tube coming out of the front panel to the nebulizer gas inlet fitting located on the nebulizer side as shown in [Figure 11](#).

Powering Up the Unit

- 1 Place the ON/OFF switch to the OFF position and plug the unit into the wall.
- 2 Turn on the unit via the ON/OFF switch.

The display will present the firmware version number and date it was created for a few seconds (the version number should be recorded as it may be required for service or troubleshooting) and will then present the signal (which should be 0 or very close to it), the temperature (which should be the ambient temperature), the pressure (which should be zero or very close to it) and the gain.

Refer to [Chapter 4](#) for preparing the unit for routine operation.

3 Installing the Detector

Installing the Nebulizer and Nebulization Chamber Assembly



4 Using the System

Preparing the System for Operation	50
Auto-zeroing the Detector	51
Routine Operation of the System	52
Installation Test Procedure	54
Powering Down and Shutting Down the System	56

This chapter describes the operations that should be performed on a routine basis when you want to collect chromatographic data using the Agilent 1200 Series Evaporative Light Scattering Detector. In this discussion, we assume that you have demonstrated that the system is operating in an acceptable manner (see [Chapter 4](#)) and that the general chromatographic conditions for the separation have been determined.



Preparing the System for Operation



To prepare the system for operation:

- 1 Power up the detector by pressing the switch on the rear panel.
- 2 Open the gas distribution valve and set the pressure to 3.5 bar (51 psi). The pressure is indicated on the **Status** screen.
- 3 Ensure that the overflow siphon for the nebulization chamber contains sufficient liquid. If necessary, pump a few ml of solvent through the system to fill the nebulization chamber.
- 4 Select the desired temperature using your control software or the instrument control (see [Appendix 9](#)). The temperature is set on the **Temp/Gain** screen, which is accessed by pressing the  button two times when the **Status** screen is presented.
- 5 Start the mobile phase flow through the system and allow the overall system to operate for at least 15 minutes to ensure that all components are equilibrated and a stable baseline is obtained.
Please refer to [Chapter 5](#) for choosing temperature settings, solvents and columns.

Auto-zeroing the Detector

Manual Auto-zeroing of the Detector

To auto-zero the detector:

- 1 Set the **Gain** to the desired value. The gain is set on the **Temp/Gain** screen, which is accessed by pressing the  button two times when the **Signal** screen is presented.
- 2 Press the  button. The detector will be automatically auto-zeroed at this point.
- 3 If the signal is to be offset, set the offset at this time. The **Offset** screen is accessed by pressing the  button when the Status screen is presented.

NOTE

The offset must be selected after the detector is auto-zeroed, as the auto-zero operation sets the signal to 0.

NOTE

If you change the gain selection, make sure that the system is auto-zeroed again before taking any measurements.

External Auto-zeroing of the Detector

If desired, the auto-zero command can be initiated by an external device such as the HPLC system controller. To employ this feature, a cable from the external device is plugged into the EXT AUTO ZERO socket on the rear panel. See [“Additional Options”](#) on page 40.

Routine Operation of the System

In general, operation of an HPLC system with evaporative light scattering detection is similar to operation of the system with other detectors.

During operation of the system, the following points should be considered:

WARNING

Health risk by exhaust gas

Exhaust gases could cause personal injury or laboratory pollution when it is lead into the laboratory.

=> Make sure that the exhaust gas from the detector is led into a fume hood or other device.

- ✓ Make sure that the exhaust from the detector is led into a fume hood or other device and make sure that there is a continuous flow of gas through the system (i.e. no constrictions or condensation traps), see [Chapter 3](#). If a vacuum is used, ensure that the vacuum effect will not disturb the detector.

WARNING

Health risk by potential leakage of hazardous solvents

Leakage of hazardous solvents could cause personal injury or laboratory pollution by pressed out liquid.

=> Make sure all flow connections to and inside the detector are tight.

=> After having switched on the LC pump for several minutes, verify that there are no leaks.

=> In case of any leak, switch off the pump immediately and remove the liquid.

- ✓ Ensure that the siphon is filled with liquid at all times. The overflow from the siphon should be collected in a suitable waste container by using the drain tube.
- ✓ Never exceed a gas pressure of 4.5 bar (67 psi).

- ✓ Avoid the use of solvent or samples that could corrode the detector. The mobile phase is in contact with glass and Teflon tubing and the evaporation tube is constructed from stainless steel. See “[Solvent Information](#)” on page 112.

Installation Test Procedure

In order to verify the correct operation of the instrument, this test procedure is used. During this test, a standard sample is run under defined conditions and the result is inspected visually by comparing it to a reference measurement. This test is not intended as a replacement for a full IQ or OQ procedure, which is available as a service from Agilent and provides quantitative results.

For running the test, please use the following measurement conditions:

Table 4 Measurement conditions for test run

Sample	Caffeine standard 250 µg/ml in water (p/n G4218-85000)
Solvent	Isocratic, 80% water, 20% Acetonitrile
Flow	1 ml/minute
Injection volume	20 µl
Column	Eclipse XDB-C18 4.6x150 5u Analytical
TCC temperature	40 °C
ELSD temperature	40 °C
ELSD pressure	3.5 bar (51 psi)
ELSD gain	7
System	Agilent 1200 Series Standard LC System with Standard Degasser, Binary Pump, High Performance Autosampler, Thermostatted Column Compartment and Diode Array Detector

After turning on the detector, allow 15 minutes for equilibration. Monitor the temperature using the Chemstation online signal display or the instrument display. As soon as the target temperature is reached and stable, start a method run using conditions listed in [Table 4](#).

A chromatogram similar to the one in the following figure can be expected. Please note that retention time, peak area and peak shape can vary and depend on the individual HPLC system configuration.

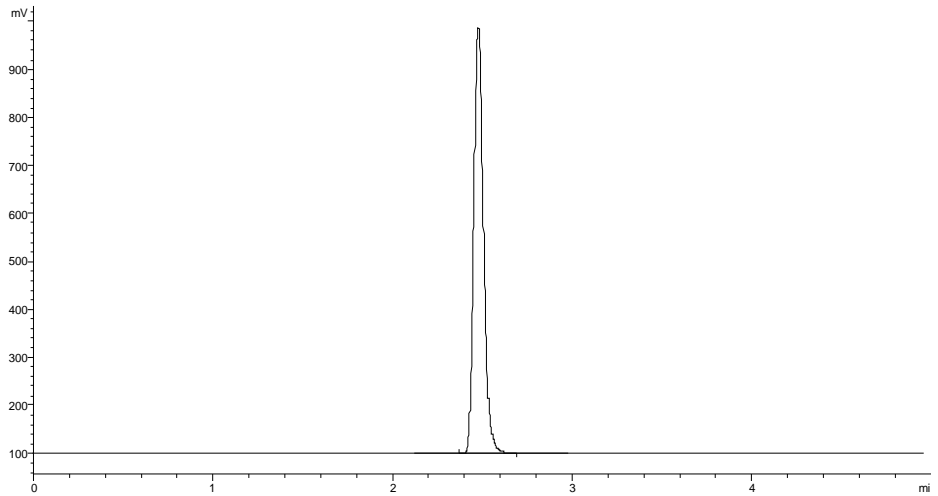

Figure 14 Typical chromatogram for caffeine, see measurement conditions in text

Powering Down and Shutting Down the System

If desired, some or all functions of the system can be powered down at the end of an automated series of analyses. These power down features are described in detail in “[The Gas Valve Screen](#)” on page 103.

To shut down the system:

- 1 Turn off the pump.
- 2 Allow the nebulization gas to flow through the detector for a few minutes to drain the evaporation tube and detection chamber.
- 3 Turn off the power to the detector (if desired).

NOTE

If you are using a mobile phase which contains salts, acids or bases, pump a few ml of water or methanol through the system before turning off the detector to prevent the deposition of substances and corrosion of the system.

If the ELSD is used as a second detector and is not used for some time, it is recommended to remove it from the liquid chromatography flow path in order to avoid blockage of the nebulizer or deposition of substances in the detector.

If the LC system shall be used without the ELSD, it must be switched off and removed from the software configuration for avoiding problems due to a missing instrument (power failure).

Cleaning the Detector

After each session and before ending HPLC use, the whole HPLC system including the ELSD should be cleaned in order to ensure good performance. For the ELSD preventive maintenance consists in cleaning the detector before shutting down after last analyses:

- 1** Let mobile phase or solvent flow to flush particles which could remain.
- 2** Eventually increase temperature in order to dissolve possible deposit.
- 3** Stop the mobile phase flow but let gas flow to dry to avoid particles deposit.
- 4** Stop the gas flow.
- 5** Shut down the detector.

The time required for each step depends on the application, used solvents, type and concentration of samples and should be determined practically.

4 Using the System

Powering Down and Shutting Down the System



5 Optimizing Performance

Selecting the Optimum Temperature 60

Optimizing the Mobile Phase 62

Optimizing the Filter 64



Selecting the Optimum Temperature

There are two factors that should be taken into account when selecting the optimum temperature for the detector:

- increasing temperature will optimize the evaporation of the mobile phase.
- decreasing temperature will minimize the decomposition of thermally labile compounds and the evaporation of semi-volatile compounds.

A very reasonable start is to set the temperature to 60°C if an aqueous mobile phase is used and 40°C if an organic mobile phase is used (these temperatures are suggested for a flow rate of 1 ml/min). At higher flow rates, higher temperatures may be required for minimizing the noise.

NOTE

If a mobile phase such as DMSO or DMF has a relatively low volatility, temperature should be increased to allow correct evaporation process.

The temperature can be adjusted easily during the method optimization process.

If you suspect that the compound of interest is thermally labile, a lower temperature could be used to improve the sensitivity by reducing the thermal decomposition. For a given flow rate and solvent, there is, however, a point at which the noise in the chromatogram is dramatically increased because not all of the mobile phase is vaporized.

As an example, consider the analysis of caffeine with evaporation temperatures of 35 °C and 60 °C (see [“Installation Test Procedure”](#) on page 54, [Table 4](#)). It is clear that the use of a low temperature provides significantly better sensitivity for volatile and thermally sensitive compounds.

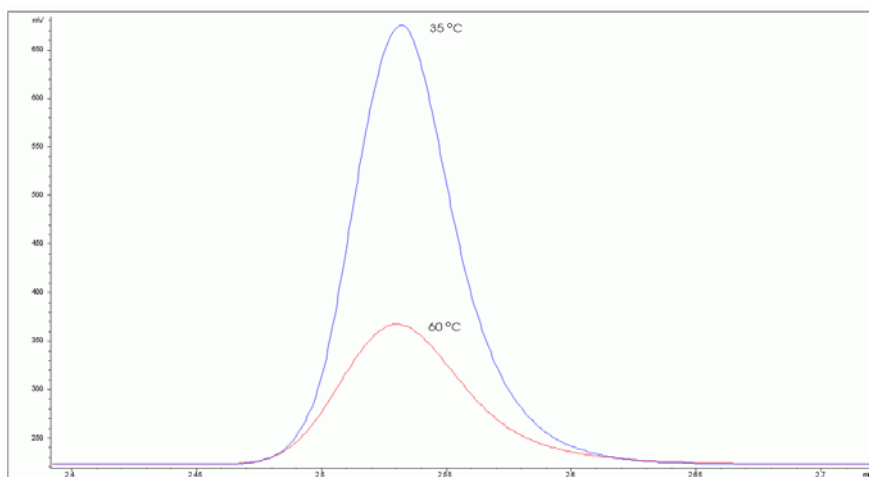

Figure 15 Chromatogram of Caffeine at Various Temperatures

The minimum temperature that can be used depends on the flow rate and the nature of the mobile phase.

Optimizing the Mobile Phase

Particulate matter in the mobile phase will increase the background and the noise.

The purity of the solvent is a critical issue in the noise. In general, filtering of the solvent is not recommended as the solvent may extract contaminants from the filter.

In most cases, distilled water and HPLC grade solvents are satisfactory. If you are comparing solvents, the most critical parameter is the dry residue; this parameter should be less than 1 ppm to maximize the sensitivity of the detector.

The mobile phase should not contain non-volatile solvent modifiers or buffers. Volatile solvent modifiers (e.g. CF_3COOH , CH_3COOH , $(\text{C}_2\text{H}_5)_3\text{N}$) can be used, but they may increase the noise level at high gain settings. In addition, the solvent should not contain preservatives, (e.g. tetrahydrofuran contains BHT as a stabilizer).

The parts of the detector which are in contact with the solvent and sample are made of Teflon, stainless steel, and glass. Make sure that the solvents are compatible to these materials.

NOTE

Depending on the mobile phase nature and flow rate, the suggested gas pressure 3.5bars (51psi) may have to be adjusted in order to optimize the background noise and the signal-to-noise ratio.

Sample Pre-Treatment

If the sample contains insoluble particles, it should be filtered through a 0.2 μm or 0.45 μm filter before injection.

Column Treatment

The chromatographic column typically contains micro-particles which are used to separate the compounds of interest. In some cases, such particles may be eluted from a column and enter the detector, which may increase in the noise.

The degradation of column packing material depends on a variety of factors including the particle size, type of column packing and the nature of the mobile phase (e.g. a high pH may degrade silica based columns).

After you have installed a new column, it is recommended that you pump mobile phase through it for a few minutes before connecting it to the detector. This will flush out micro-particles that may reside in the column from the manufacturing or shipment process. It is suggested that you perform the Column Noise test (see [“Column Noise Test”](#) on page 77) to obtain the baseline signal value for the column.

Optimizing the Filter

The Digital Filter (see “[The Noise Filter/Pressure Unit Screen](#)” on page 101) allows maximizing signal-to-noise ratio by filtering noise. The filter length should be optimized according to peak shape, and more specifically to peak width.

The following table suggests some Filter settings depending on peak width :

Table 5 Digital Filter suggestion versus Peak Width

Peak width at 50% (Seconds)	Suggested filter (Seconds)
<1 second	0 second
2	1
4	2
6	4
8	6
>10	8 and higher

These suggested values can be optimized depending on your specific chromatography, by decreasing the filter length if peaks are poorly resolved (e.g. if $R_s < 1.5$), or increasing Filter when optimizing Signal to Noise ratio.

Example: Comparison of digital filters using the SOP test (injection of 5 ppm glucose at gain 12). Peak width at half-height is 2.5S.

Table 6 Sensitivity improvement depending on Filter

	Filter 0S	Filter 1S	Filter 2S
Signal height	124 mV	122 mV	110 mV
Noise (ASTM)	3.2 mV	1.1 mV	0.7 mV
Peak width (at 50% height)	2.5 seconds	2.5 seconds	2.8 seconds
S/N	37	110	157

Signal to noise ratio is multiplied by 3 when choosing Filter 1S without any peak broadening effect. If Signal to Noise ratio is more important than resolution, a Filter 2S or higher can be set to improve sensitivity even more.

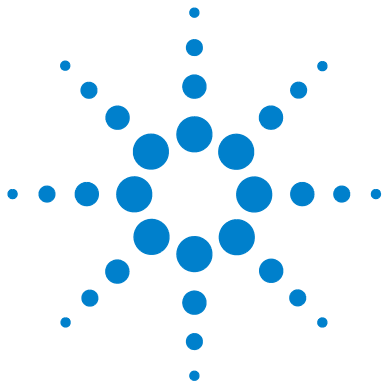

6 Troubleshooting and Diagnostics

Basics of Troubleshooting	66
Specific Detector Troubleshooting	70
Noise test procedures	71
Troubleshooting based on diagnostic tests	78
Troubleshooting based on instrument signals	79

This chapter describes troubleshooting activities which are useful for determining the cause of wrong or unexpected.



Basics of Troubleshooting

The Agilent 1200 Series Evaporative Light Scattering detector is designed to be used with a liquid chromatography system. For troubleshooting, it is important to distinguish between detector issues and issues with other parts of the system, which might affect detector output.

Troubleshooting refers to the task of finding the reason for an abnormal response from the system and the following guidelines should be used to determine the problem:

- ✓ It is important to recognize that in almost all cases there are several possible causes for a problem. As an example, an increase in the noise of the chromatogram could be due to
 - a defective nebulizer
 - the slow elution of very tightly retained material from the column
 - a unsuitable mobile phase (non-volatile buffers, high dry residue amount)
 - an increase in pump pulsation
 - the solvent e.g. improper degassing or high residue after evaporation
 - the pump, e.g. a defective check valve
 - the detector, e.g. an electronic problem
 - the gas supply, e.g. particles in the gas line.
- ✓ Check the nebulizer. The flow from the nebulizer should be fine and homogeneous. If it is not, the nebulizer, the needle or the Teflon tube may be obstructed with foreign material.

It is rather unlikely that two problems occur at the same time. The role of the troubleshooting activities is to determine the cause of the problem. In this discussion, we will assume that the operator has determined that other components of the system are operating properly.

WARNING

Destruction of the nebulizer by disassembly

Disassembling the nebulizer will destroy it.

=> Do not disassemble the nebulizer.

NOTE

The control panel and system electronics do not contain any replaceable components. If the suggestions provided in this chapter do not remedy the problem, contact your Agilent service representative.

If the digital display does not illuminate when the system is powered up, turn the unit off and inspect the main fuses. If necessary, replace the fuses with some of the same rating as the original fuse (3.15 AT (time-delayed), part number G4218-68005) for units of all voltages. The fuses are located inside the main power module on the rear panel (Figure 8). A set of replacement fuses is delivered in starting kit.

If the fuses are not blown or if the replacement fuses blow up, contact your Agilent service representative.

Initial Troubleshooting Activities

- ✓ Make sure that the instrument and all components of the system are grounded properly.
- ✓ Ensure that the liquid level in the siphon is appropriate, and that there is no liquid accumulating in the nebulization chamber.
- ✓ Check that the gas pressure is sufficient (3.5 bar target, 3 bar minimum, 4.5 bar maximum) and is stable. The gas filter should be clean and in place.
- ✓ Ensure that the flow rate of the pump is constant and check that there are no leaks in the chromatographic system.

If there is no response from the system

If there is no response from the system when the unit is powered up (e.g. the fan does not rotate, the display does not light up, the light source is off, etc.) it is likely that the instrument is not getting power.

- ✓ Check that the unit is plugged into an active mains line.
- ✓ Check that the mains line voltage corresponds to the detector voltage version.
- ✓ Disconnect the system from the power line and check the mains fuses. The mains fuses are in the vicinity of the power line socket as shown in Figure 1. Pry the plastic cover off the fuse holder to access the fuses and inspect them. If a fuse(s) is blown, replace it with one of the same rating (T3.15 AL/230V, part number G4218-68005)

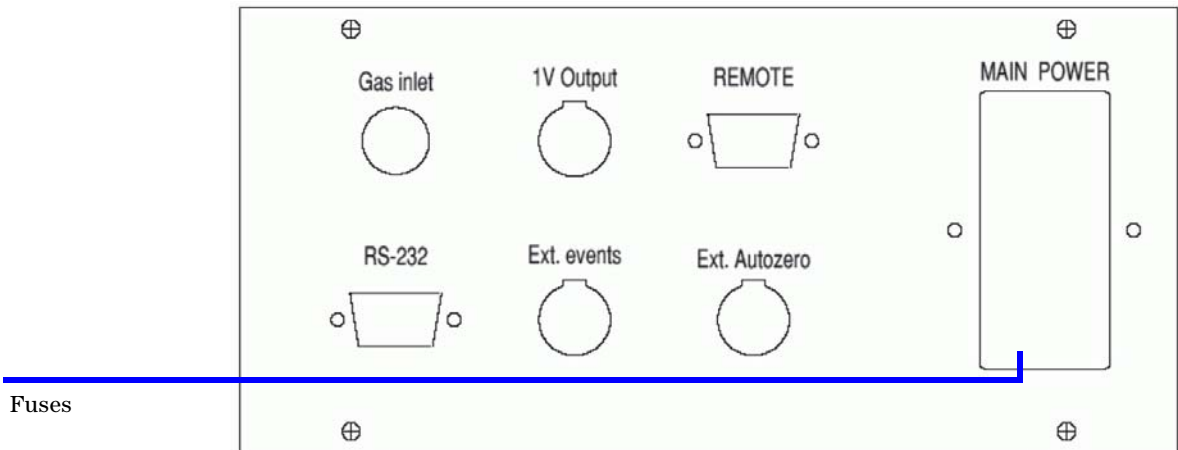

Figure 16 Control Panel

Perform the Noise Tests

Repeat the tests described in “[Installation Test Procedure](#)” on page 54 and compare the observed data to the limits defined for these values

For example, if the Electronic Noise test (see “[Electronic Noise Test](#)” on page 73), Background Noise test (see “[Background Noise \(Stray Light\) Test](#)” on page 74) and Solvent Noise test (see “[Solvent Noise Test](#)” on page 75) provide results which are well within limits but the Column Noise test (see “[Column Noise Test](#)” on page 77) fails or is significantly different from values obtained for comparable measurement conditions (same system setup, solvent column), it is likely that the problem is due to the column (e.g. highly retained compounds are being eluted).

Specific Detector Troubleshooting

- ✓ The mist from the nebulizer should be homogeneous. If it is not homogeneous, the nebulizer, the needle or the Teflon tube may be obstructed. To remove the obstruction, pump a solvent that can dissolve the foreign material. As an alternative, the nebulizer can be placed in an ultrasonic bath to dissolve the foreign material. Instructions about cleaning of the nebulizer for cleaning are presented in “[Cleaning the Nebulizer](#)” on page 86.

NOTE

Do not disassemble the nebulizer, this will void the warranty

- ✓ If the sensitivity of the system is low, ensure that there are no leaks in the system. In some cases, a small increase in the gas pressure (e.g. 0.1 or 0.2 bar) may solve the problem. Alternatively, a new LED may be required or the nebulizer might be obstructed.
- ✓ If the detector signal is saturated or if there is a decrease in the dynamic range of the system, it is possible that a residue is passing through the detector cell; this will lead to an intense signal due to a significant amount of light scattering. This residue may be derived from the elution of strongly retained materials from the column, or may be derived from the solvent. For determining the cause of the problem, bypass the column and observe the signal intensity:
 - if the signal returns to normal, strongly retained materials are eluting from the column. Flush the column with a strong solvent to elute all material.
 - if the signal does not return to normal, the solvent contains a residue material and is not suitable for use with the detector.
- ✓ If the noise of the system without solvent is high or if ghost peaks occur, it is possible that foreign material is present in the drift tube. In this situation, increase the temperature to 90°C and pump solvent at the rate of 2 ml/min, using a gas pressure of 3.5 bar (51 psi).

Noise test procedures

This section describes some procedures, which can be helpful for troubleshooting and help the user to distinguish detector issues from issues caused by other elements contributing to the measurement result like solvents or the column. 4 tests are described, which add more of these elements step by step, so their contribution can be measured.

- ✓ The electronic noise test measures the signal created by the detector without irradiation and solvent flow.
- ✓ The background noise/stray light test measures the signal measured by the detector, while the light source is on, but no sample or solvent flow through the detector
- ✓ The solvent noise tests measures the signal created by pure solvent flowing through the detector while no column is installed
- ✓ The column noise test measures the signal created by pure solvent flowing through the column and the detector.

Preliminary Activities

NOTE

Before starting the tests for new instruments or after storage, flush detector with water at a flow of 1 ml/min for at least 15 minutes.

The following activities should be performed:

- 1 Power up the instrument.
- 2 Set the gain to 1 and the offset to 0 mV. The **Signal** screen should indicate 000 (or a very small signal).
- 3 Access the **Temperature/Gain** screen, set the temperature to 50°C and press .
View the **Status** screen and verify that the temperature is rising to the setpoint on the **Status** screen.
- 4 Provide gas to the detector and adjust the pressure to 3.5 bar (51 psi). If the pressure is less than 3 bar (44 psi), an error message will be presented indicating that the detector is not ready.

CAUTION

Damage of pressure sensor

Pressures above 4.5 bar (67 psi) can damage the pressure sensor of the detector. The gas consumption for the large nebulizer is 4 l/min and 3 l/min for all other nebulizers. The target pressure for most applications is 3.5 bar (51 psi).

=> Do not switch on the gas flow suddenly, as this may cause the exceeding of maximum pressure. The use of a separate pressure regulator is highly recommended. A filter (0.01 µm) and manometer (part number G4218-60100) is available as an option. Replacement filter cartridges are available as part number G4218-40150.

- 5 Press the  button.
The signal should read close to zero and remain constant.
- 6 Set the noise filtering to **1S** (see “The Noise Filter/Pressure Unit Screen” on page 101).

Electronic Noise Test

NOTE

For this test, do not turn on the light source. Do not turn on the HPLC pump (no solvent flow).

To determine the electronic noise:

- 1 Make sure the siphon is filled and the bulkhead is blocked with a blank nut or Parafilm™ to avoid a Venturi effect.
- 2 Switch on the gas flow at 3.5 bar (51 psi).
- 3 Set the temperature to 50 °C. Wait for stable temperature.
- 4 Set the Gain to 12.
- 5 At gain 12, monitor the signal for a period of 5 min. The variation in the signal should be less than +/- 2 mV (there may be some spiking of the signal).
- 6 Record the level and autozero the detector again.

Background Noise (Stray Light) Test

NOTE

For this test, the HPLC pump must be off (no solvent flow).

To determine the background noise :

- 1** Make sure the siphon is filled and the bulkhead is blocked with a blank nut or Parafilm™ to avoid a Venturi effect.
- 2** Switch on the gas flow at 3.5 bar (51 psi).
- 3** Set the temperature to 50 °C. Wait for stable temperature.
- 4** Switch on the light source.
- 5** Set the Gain to 1.
- 6** Set the offset to 0 mV.
- 7** Wait 15 minutes for stabilization and record the signal level.
- 8** Increase the gain to 12 and monitor the signal.
The expected level is typically 100 mV to 150 mV.

Solvent Noise Test

To determine the solvent noise:

- 1 Make sure the siphon is filled and the bulkhead is blocked with a blank nut or Parafilm™ to avoid a Venturi effect.
- 2 Switch on the gas flow at 3.5 bar (51 psi).
- 3 Set the temperature to 50 °C. Wait for stable temperature.
- 4 For now, keep off the HPLC pump.
- 5 Switch on the light source.
- 6 Set the gain to 12 and monitor the signal.
Do not autozero the detector. The signal may be negative.
- 7 Bypass the column of your HPLC system.
- 8 Connect the detector to the mobile phase delivery system and pump the solvent that you expect to use for your analyses through it at a flow rate of 1 ml/min.
- 9 Monitor the baseline for a few minutes.
 - If water is used as the solvent, the signal should be 10 mV or less. Higher values could be observed if non-HPLC grade water is used, which may have a higher non-volatile residue.
 - If an organic solvent is used, the signal should be 200 mV or less.
 - For mixtures of water and organic solvents, the expected signal can be estimated by linearly interpolating to the concentration of organic phase in the solvent (e.g. a mixture of half and organic solvent (50:50) should provide a signal of approximately less than 105 mV).

If the instrument fails the Solvent Noise test, it is most likely due to an impurity in the solvent rather than a fault with the instrument. A different supply of solvent should be obtained and employed (MS grade solvents or lowest dry residue (< HPLC grade) solvent should be used for this test).

The purity of the solvent is critical for a low background noise. In most cases, distilled water and HPLC grade solvents are satisfactory. When you are comparing solvents from different sources, the most critical parameter is the *Residue after Evaporation*; this parameter should be less than 1 ppm to maximize the sensitivity of the detector. Mass spectroscopy grade solvents have a very low dry residue.

6 Troubleshooting and Diagnostics

Noise test procedures

The mobile phase should not contain non-volatile solvent modifiers. Volatile solvent modifiers (e.g. CF_3COOH , CH_3COOH , $(\text{C}_2\text{H}_5)_3\text{N}$) can be used, but they may increase the noise level at high gain settings. In addition, the solvent should not contain preservatives, (e.g. tetrahydrofuran normally contains BHT as a stabilizer)..

When filtering solvents, only use filters recommended for the use with HPLC systems, as the solvent may extract contaminants from other filters. Stainless steel filters should be preferred over glass filters and others. (HPLC grade solvents or lowest dry residue solvent should be used for this test).

If changing the solvent source does not solve the problem, it may be necessary to decontaminate the system as described in “[General inspection](#)” on page 82 or clean the nebulizer as described in “[Cleaning the Detector](#)” on page 83.

Column Noise Test

NOTE

It is recommended that a specific column is reserved for this test. This column should not be used for routine analyses. If a column is used for a number of different separations, it is possible that some compounds can be tightly bound to it and slowly eluted over time. When tightly bound compounds are slowly eluted from the column, excessive noise will be observed.

To determine the column noise:

- 1 Turn off the pump and connect the column.
- 2 Restart the pump and allow the mobile phase to flow through the system. It is suggested that you flush the column with a strong solvent for a few minutes before attaching it to the detector. The flow rate to be applied depends on to the column ID and is indicated in the following table:

Table 7 Flow rate versus Column diameter indication

Column ID (mm)	Flow Rate (µl/min)
4.6	1000
2.1	208
1.0	47
0.8	30
0.32	4.8

- 3 Set the gain to 12 and monitor the baseline for a few minutes. A suitable column will provide a baseline that is 20-50 mV above the solvent baseline.

If the instrument fails the Column Noise test, it is most likely the fault of the column rather than the instrument. Obtain a new column and repeat the test.

NOTE

If the mobile phase contains acidic modifiers (e.g. CF₃COOH), disconnect the detector and wash the HPLC system for 12 h before starting to analyze unknown samples. This wash should be performed after the column noise test is completed, but does not need not be performed after each analysis.

Troubleshooting based on diagnostic tests

If the actions described in the noise test procedures (see [“Noise test procedures”](#) on page 71) do not solve the problems of failing tests, following actions should be performed by the service.

Electronic noise test

In case the electronic noise is higher than expected, see [“A noisy signal is observed”](#) on page 80.

Stray light test

In case the intensity of the stray light/background noise is out of the expected range, see [“No signal is observed”](#) on page 79.

Failed run of standard sample

In case the noise tests have passed, but the peak area for a standard is lower than previous reference measurements, check the nebulizer (see [“Cleaning the Nebulizer”](#) on page 86), make sure you are using a fresh sample and consider running the test using a backpressure loop instead of a column.

Troubleshooting based on instrument signals

In all cases of troubleshooting for the detector signal, noise tests as described in “[Perform the Noise Tests](#)” on page 69 should be run in order to distinguish detector problems from application or system problems and in order to acquire parameters under defined conditions.

No signal is observed

If no signal is observed:

- ✓ Make sure that the light source is on.
- ✓ Run a stray light test and check, whether the stray light signal for gain 12 is in the range of 100 mV to 150 mV.
- ✓ Check that the gas valve is opened and the pressure regulator is opened (if any). A pressure display that is greater than 0 indicates that there is gas flow.
- ✓ If the stray light test passes and the gas flow is on, the nebulizer is probably blocked. Clean the nebulizer as described in “[Cleaning the Nebulizer](#)” on page 86.
- ✓ If cleaning the nebulizer does not solve the problem, replace the nebulizer.

Decrease in sensitivity

If noise tests did not show that the problem could be caused by the application or system, a decrease in the sensitivity is often caused by the nebulizer (main cause) or the detector sensing section.

If noise tests pass but the signal heights/areas for known standards are too low, the nebulizer might need to be replaced. Please note that the root cause might also be in a different module, e.g. volumes injected by the autosampler might be too low or dead volumes in capillary connections cause peak broadening.

If the stray light test gives signals which are too low

- ✓ Use the instrument keyboard for checking if the life time of the light source has been exceeded. If needed, please contact your Agilent service representative for a replacement.
- ✓ Set the stray light to the original value. See [“The Light source Normalization Screen”](#) on page 102.

A noisy signal is observed

NOTE

High noise is often due to a lack of maintenance. The detector should be cleaned on a routine basis.

If the signal is noisy, apply noise tests in order to ensure that the high noise is not due to the mobile phase or the column. Then:

- 1 Do a general inspection as described in [“General inspection”](#) on page 82
- 2 Clean the nebulizer as described in [“Cleaning the Nebulizer”](#) on page 86.
- 3 Exchange the nebulizer.



7 Maintenance

General inspection	82
Cleaning and Decontamination	83
Adjusting stray light settings	89

This chapter describes:

- The maintenance procedures that should be performed by the operator on a routine basis (see “[General inspection](#)” on page 82).
- Cleaning and decontamination procedures that should be performed to maintain instrument performance (see “[Cleaning and Decontamination](#)” on page 83).



General inspection

The Agilent 1200 Series Evaporative Light Scattering detector is designed for a low level of maintenance activities. Maintenance activities are normally the responsibilities of the user. If preventive maintenance activities are followed, the system provides high sensitivity measurements without intervention of the operator.

- ✓ Ensure that the detector is installed according to the site requirements (see “Site Requirements” on page 20) in a clean laboratory environment, away from sources of heat or ventilation.
- ✓ Make sure that the detector exhaust is vented to a fume hood or lab exhaust line.
- ✓ Check that the detector is kept clean. There should be no foreign material on the joints, in the nebulizer, the glass tube, etc.
- ✓ Make sure the siphon of the nebulization chamber is filled with solvent. Ensure that the gas flow does not bubble through the siphon and the liquid level is not fluctuating. If this should be the case, check for a correct installation of the exhaust tube and make sure the vacuum applied there is neither too strong nor too weak.
- ✓ Check the nebulizer. The flow from the nebulizer should be fine and homogeneous. If it is not, the nebulizer, the needle or the Teflon tube may be obstructed with foreign material. Clean the nebulizer as described in “Cleaning the Nebulizer” on page 86.
- ✓ All tubing should be in good shape. Any damaged tubing or tubing with kinks should be replaced.
- ✓ All cables should be in good shape. Any electrical cables that are frayed or damaged should be replaced.
- ✓ Only use filtered oil-free pressurized gas.

Cleaning and Decontamination

Cleaning the Detector

WARNING

Shock hazard and damage of detector

Liquid drip into the detector could cause shock hazard and damage the detector.

=> Do not let liquid drip into the detector

- 1 Turn the instrument off.
- 2 Unplug all connection cables, the gas input and nebulizer tubing before cleaning.
- 3 If the unit has been powered up, wait for it to cool down before proceeding.
- 4 Clean the instrument with a clean, non-abrasive rag. If necessary, a solvent such as isopropanol can be used.

Decontaminating the detector

WARNING

Health risk by potentially harmful substances

The toxicological properties of many samples separated by the HPLC system are usually not well known. They could cause toxications and other health risks.

=> If you have any doubt about the cleanliness of a detector, treat the detector as if it contained a potentially harmful substance and decontaminate it before working on it.

7 Maintenance

Cleaning and Decontamination

To decontaminate the detector:

- 1 Power up the detector and allow nebulizer gas to flow through it in the normal manner.
- 2 Deliver a mobile phase that will dissolve the contaminant at a flow rate of 1 ml/min. If you do not know what the contaminant is, ethanol or acetone are good choices.
- 3 Access the temperature adjustment mode via the control panel.
- 4 Push and hold the  button for 5 s. This will automatically set the temperature to 100°C.
- 5 Maintain the flow and temperature for at least 3 hours.
- 6 Clean the exterior of the detector with a rag saturated with isopropanole.

Removing the nebulization chamber and nebulizer

If the nebulizer shall be stored afterwards, please flush the nebulizer and shut down the system as described in [“Powering Down and Shutting Down the System”](#) on page 56.

- 1 Turn off the LC pump or any other mobile phase flow.
- 2 Turn off the ELS detector.
- 3 Stop the gas flow using the external pressure regulator.



Figure 17 Replacing the nebulization chamber

For subsequent steps, see [Figure 17](#).

- 4** Remove the capillary connection to the mobile phase
- 5** Remove the connection to pressurized gas by pushing on the white inlet (see arrow).
- 6** Remove the drain tube.

7 Maintenance

Cleaning and Decontamination

7 Remove the small black plastic nut at the rear and carefully lift out the nebulization chamber.

8 Remove the large black plastic nut at the top and remove the nebulizer.

If you want to store the nebulizer, clean the nebulizer as described in [“Cleaning the Nebulizer”](#) on page 86 and protect all openings using Parafilm™ or similar polymer foils.

For re-installing the nebulizer or replacing it by a new one or different type, reverse the order of previous steps as described in [“Installing the Nebulizer and Nebulization Chamber Assembly”](#) on page 43. In case the black gas tubing has been removed, make sure you are using the correct orientation, where the white filter is at the lower end. Avoid leaks at all connections and check for leakages when you turn on the pump again.

CAUTION

Damage of flow cells.

When using the ELSD with another detector, using a flow cell which is not compatible with the back pressure generated by the chosen ELSD nebulizer can destroy the flow cell.

=> See [“Nebulizers for the G4218A Agilent Evaporative Light Scattering Detector”](#) on page 94 for nebulizer back pressures and compare them to the specifications of your flow cell.

Cleaning the Nebulizer

WARNING

Damage of the nebulizer rare part

Improper handling of the nebulizer can damage the part.

=>Handle the nebulizer with care and do not disassemble the rear part of the nebulizer, which is protected by the colored thermal seal.

To remove the nebulizer from the system:

- 1 Turn off the HPLC system.
- 2 Disconnect the nebulizer liquid inlet from the column.
- 3 Disconnect the gas inlet from the nebulizer.

- 4 Remove the nebulizer from the detector, taking care to never pull on the rear connection tubing.
- 5 Remove the nebulizer black nut and seal.
- 6 Remove the gas inlet quick fitting.

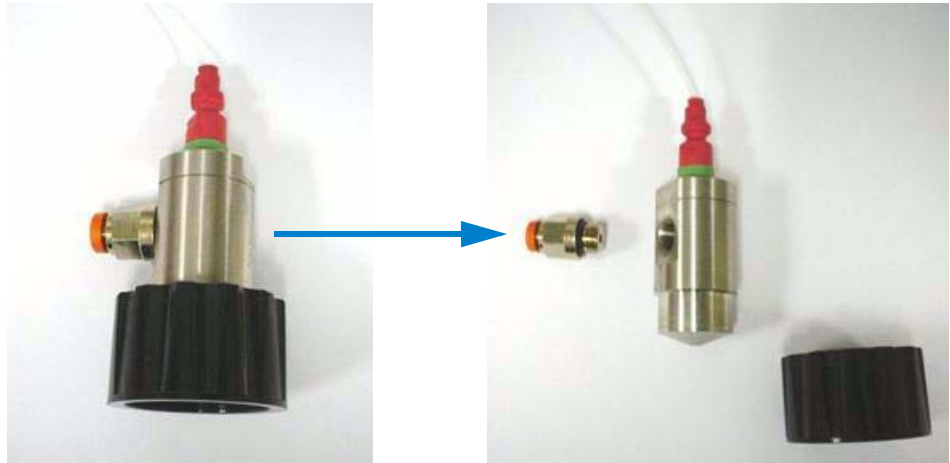

To clean the nebulizer:

- 1 Fill an ultrasonic bath with approximately 2 cm of the appropriate solvent, which depends on the nature of the material that is present in the nebulizer. In most cases, ethanol is a satisfactory solvent.
- 2 Place the nebulizer vertically in the solvent bath. The nebulizer outlet should be placed at the bottom.

7 Maintenance

Cleaning and Decontamination



maximum liquid level

- 3 Clean the nebulizer for approximately 30 minutes with the solvent, and then replace the solvent with water and clean for an additional 30 minutes.

To fix up the nebulizer:

- 1 Fix the gas inlet fitting on the nebulizer (see [“Installing the Nebulizer and Nebulization Chamber Assembly”](#) on page 43).
- 2 Fix the nebulizer on the nebulization chamber.
- 3 Test the nebulizer to ensure that it is working properly.

If the performance cannot be improved by cleaning the nebulizer, a new nebulizer might be required.

Adjusting stray light settings

You may set the desired stray light using the instrument keyboard.

7 Maintenance
Adjusting stray light settings



8 Parts for Repair

Evaporative Light Scattering Detector Parts [92](#)



Evaporative Light Scattering Detector Parts

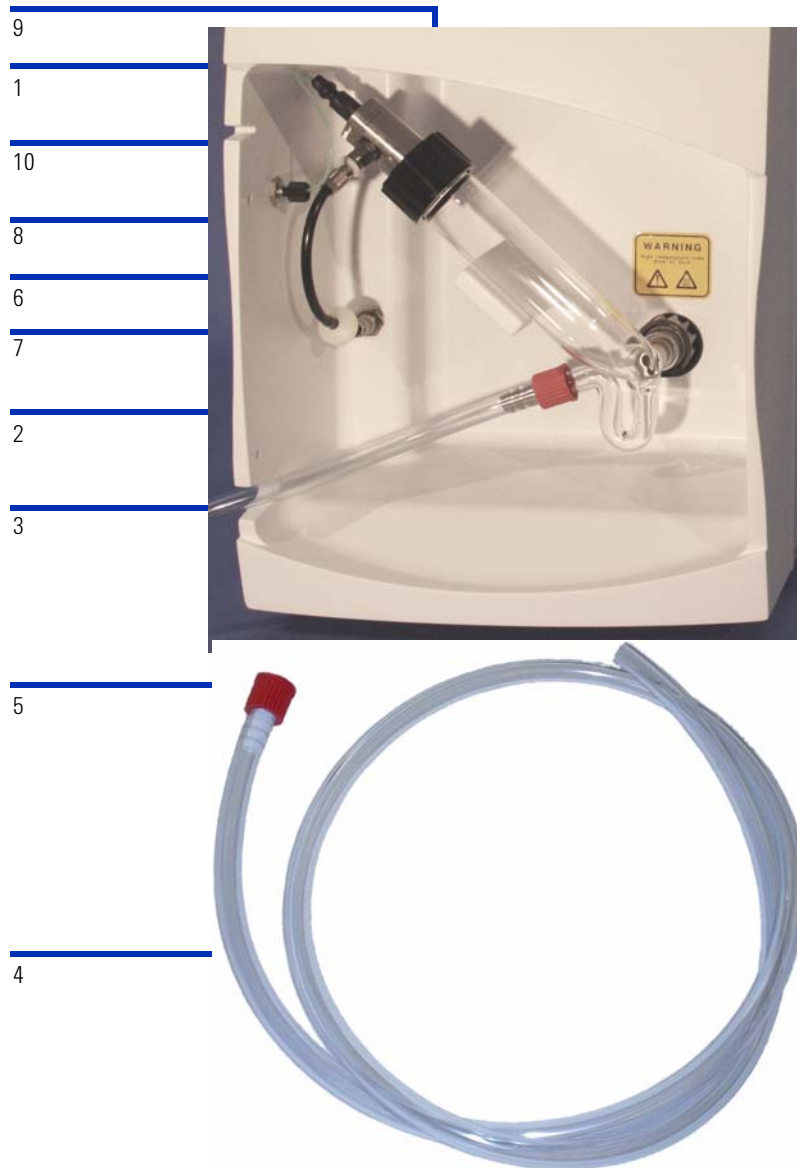

Figure 18 Evaporative Light Scattering Detector Parts

Table 8 Evaporative Light Scattering Detector Parts

	Part	Part Number
1	Nebulizer Assembly [1]	see list below
2	Nebulization Chamber (glass)[2]	G4218-40000
3	Black Plastic Nut for Nebulization Chamber (13 mm Diameter) [3]	G4218-40010
9	Black Plastic Nut for Nebulization Chamber (30 mm Diameter) [9]	G4218-40011
	Seal kit for nebulization chamber	G4218-68010
	Gas Regulator with Filter and Manometer	G4218-60100
	Cartridge for Gas Regulator	G4218-40150
4, 5	Drain Assembly (includes fitting [5]) [4]	G4218-40100
	Drain Bottle	G1946-60111
	Black Exhaust Tube, 2.5 m	G4218-40110
	¾ inch PE Tubing for Drain Bottle, per cm	0890-1727
	Tube Fitting (6 mm diameter) for Gas Regulator	G4218-40160
6	Pneumatic tube (diameter 4 mm) for Nebulizer (includes stainless steel fitting [6])	G4218-40220
	Detector Gas Inlet Tube 6 mm O.D., 10 m	G4218-40170
7	Wall Mounting Fitting (4 mm diameter) [7]	G4218-40140
8	Bulkhead Fitting [8]	G4218-40130
	Front panel shield window	G4218-40400
	Autozero Cable	G4218-81101
	Signal Cable	G4218-81100
	RS 232 Cable	G4218-81103
	External Event Cable	G4218-81102
	Cable Remote	5061-3378
	Caffeine Standard 250 µg/ml in water	G4218-85000

8 **Parts for Repair**
 Evaporative Light Scattering Detector Parts

Table 9 Nebulizers for the G4218A Agilent Evaporative Light Scattering Detector

Nebulizer	Useable Flow Range	Optimum Flow Range*	Nebulizer Back Pressure - bar (with water)	Identifying Marks	Part Number
Micro Flow Nebulizer	5.0 µl/min – 40.0 µl/min	15.0 µl/min – 25.0 µl/min	24 (100 µl/min)	Blue Seal 2 Rings	G4218-20003
Semi Micro Flow Nebulizer	0.04 ml/min – 1.0 ml/min	0.1 ml/min – 0.3 ml/min	44 (1 ml/min)	Yellow Seal 2 Rings	G4218-20001
Standard Flow Nebulizer	0.2 ml/min – 2.0 ml/min	0.5 ml/min – 1.2 ml/min	4 (1 ml/min)	Black Seal 2 Rings	G4218-20000
Large Flow Nebulizer	1.0 ml/min – 5.0 ml/min	2.0 ml/min – 3.0 ml/min	4 (1 ml/min)	Red Seal 1 Ring	G4218-20002
Rapid Resolution Nebulizer	0.2 ml/min – 1.4 ml/min	0.4 ml/min – 1.0 ml/min	14 [†]	White Seal 1 Ring	G4218-20004

* The optimum flow range provides highest sensitivity and repeatability

† 14 bar at 1.4 ml/min with water/acetonitrile, 50:50)



9 The Control Panel

The Control Panel 96

This chapter describes the role of the controls and the digital display on the control panel



The Control Panel

The Control Panel (Figure 19) includes a digital display and a number of buttons that are used to enter data.

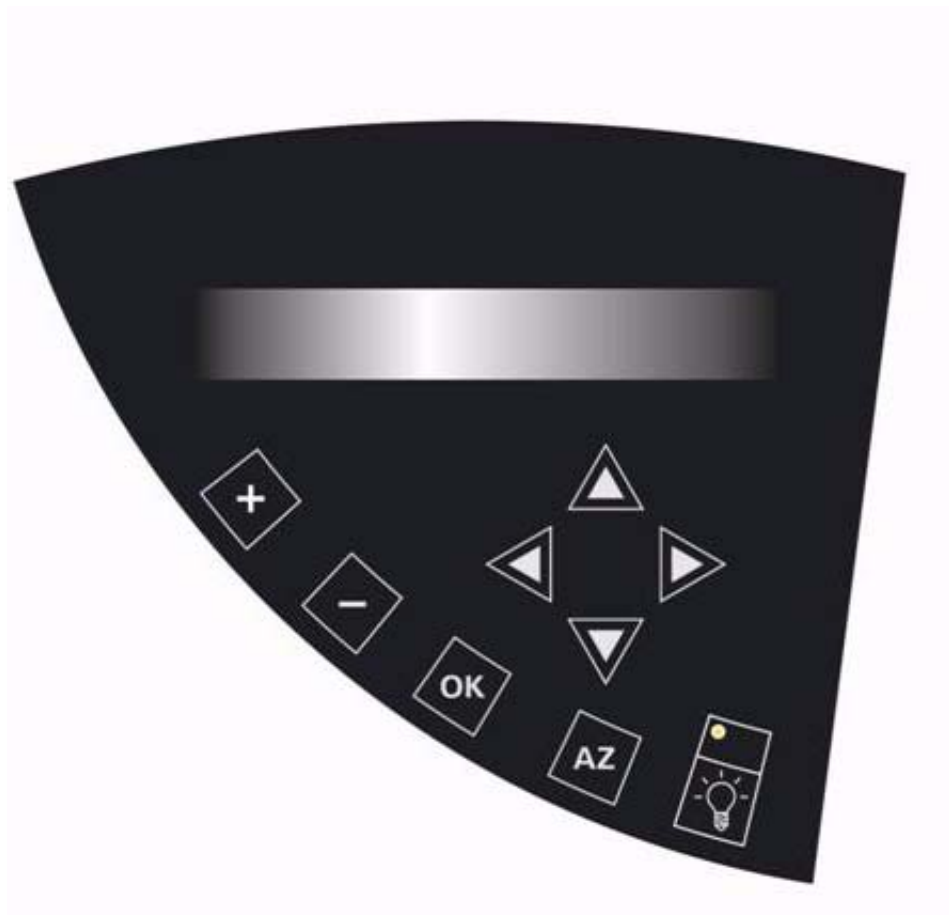

Figure 19 The Control Panel

The Digital Display

The digital display presents information about the present status of the detector and is used for controlling its measurement parameters. When the detector is powered up, the display will present a greetings message that includes the version number and date that the version was created for a few seconds. After the system has completed the initialization procedures, the **Status** screen (Figure 20) will be presented. The signal should be close to zero.

Signal	Temp	Press	Gain
001	26°C	3.5b	1

Figure 20 The **Status** Screen

The user interface is provided via a series of screens, see “[The User Interface](#)” on page 98. Some screens present information about the instrument status and cannot be edited by the user (e.g. the **Status** screen), while other screens (e.g. the **Temperature/Gain** screen, [Figure 22](#)) are used to enter control parameters.

NOTE

The control panel is disabled while the instrument is controlled externally via an RS232 connection (Chemstation etc.).

The keys on the control panel are used to provide the following functions:



used to increase the present value of a user settable parameter (e.g. the offset) by 1 unit. If you keep the key pressed, the rate of change of the parameter will increase.



used to decrease the present value of a user settable parameter (e.g. the offset) by 1 unit. If you keep the key pressed, the rate of change of the parameter will increase.



sets the value of the parameter that you have edited.



sets the present intensity for the detector to zero.



is used to power the LED in the detector. When the LED is lit, the keyboard LED immediately above the button will be illuminated.



changes the active line on the display to the next (previous) line or the next (previous) screen.



moves the cursor on the display to the next (previous) field.

The User Interface

The **Status** screen (Figure 20) is the default screen and is presented after initialization of the detector. In addition, it will be automatically presented again if you have accessed another screen and have not made any keystrokes within a few seconds.

Each parameter change must be validated with  or the change will not be applied.

The Status Screen

The **Status** screen (Figure 20) displays the current measurement values of the detector. This screen cannot be edited, but the desired offset can be set via the **Offset** screen (Figure 21), the temperature and gain can be set via the **Temp/Gain** screen (Figure 22) and the pressure units can be selected via the **Noise Filter/Pressure Unit** screen (Figure 24).

The temperature value blinks if desired temperature is not reached and stable. The pressure value blinks if the gas pressure is lower than 3.0 bar.

When the  button is pressed; the **Offset** screen (Figure 21), which is used to select the desired offset is presented.

The Offset Screen

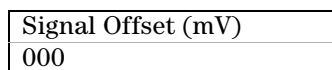







Figure 21 The **Offset** Screen

To increase the offset value, click on the  key. If you press the button quickly, the offset will increase by 1; if you press and hold the button, the value will increase at the rate of 20 mV/s.

Once you have set the desired offset, press the  button to accept the new value. Please note that for user convenience, a fast offset setting can be done in the **Status** screen (Figure 20), simply by pressing the  or  key. This will change the offset value immediately.

Press the  button to access the **Temp/Gain** screen (Figure 22).

The Temperature/Gain Screen

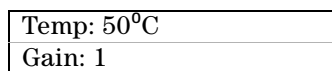







Figure 22 The **Temp/Gain** Screen

The **Temp/Gain** screen is used to set the desired Temperature and Gain. When the screen is accessed, the cursor is on the **Temp** setting. This setting can be changed with the  and  buttons and validated by the  button. The temperature range is 20 to 100°C.

NOTE

To maintain appropriate temperature control, the temperature should be set at least 5 °C above ambient. A wait time of 15 to 30 minutes is recommended for achieving good temperature stabilization.. The stabilization time for detector temperatures close to the ambient temperature is longer than for high temperatures.

When you press the  button, the **Gain** field can be edited. The gain range is from 1-12, each increment of one unit increases the gain by a factor of 2 (e.g. if you change the gain from 1 to 4, the gain is increased by a factor of 8) and the full range of the gain is 1-2048. After setting the desired gain, press the  button for navigating to the **Autozero offset** screen (Figure 23).

The Autozero offset Screen

Output Signal Value
After AZ : <i>xxx</i> mV

Figure 23 The **Autozero offset** Screen

This screen is used to allow the signal to reach the desired value when performing an autozero (by keyboard, software control or external contact closure).

This function can be helpful when the user wishes to have a positive signal value instead of zero, especially with some acquisition systems which have only positive signal acquisition capability.

This setting can be changed with the  and  buttons and validated by the  button.

After you have set the desired autozero offset, press the  button for navigating to the **Noise Filter/Pressure Unit** screen (Figure 24).

The Noise Filter/Pressure Unit Screen

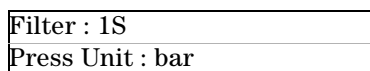

Figure 24 The **Noise Filter/Pressure Unit** Screen

The **Filter/Pressure Unit** screen displays the settings for digital filtering of the signal data and the selected measurement unit (bar, kPa or psi) for the pressure display.

When the screen is displayed, the cursor is on the **Filter** field. By pressing \oplus or \ominus keys, you change the filtering strength within the following range :

- "NO" : no filtering.
- 0.5S : 0,5 second moving average filtering.
- 1S...10S : 1 to 10 seconds moving average filtering.

NOTE

For better results, the digital filter should be used unless the peak(s) of interest are very poorly resolved (e.g. when $R_s < 1.5$).
Default value is 1S, corresponding to a peak width of approximately 2 seconds at half-height. See "[Optimizing the Filter](#)" on page 64 for details on filter optimization.



If you have changed the value, press \otimes to validate it before you press the ∇ button to access the **Press Unit** line. The pressure unit line allows for the selection of bar, kPa or psi for pressure units, the desired selection is made via the \oplus or \ominus key, and validated by the \otimes key.

When you press the ∇ button, the **LED** screen ([Figure 25](#)) will be shown.

The LED Screen

LED : ON	#H
Reset Time Elapsed	

Figure 25 LED Screen

The **LED** screen is used to turn the light source on/off and is equivalent to the **Light source** button on the control panel. Use the  button followed by the  button to turn the LED on and the  button followed by the  button to turn it off.

The **# hours** field indicates the number of hours that the LED has been in use. The lifetime of the LED is approximately 5000 h. When this period has been reached, a message will be displayed after powering up the unit, that the maximum usage of the lamp has been exceeded. To reset the field, move the cursor to the **Reset Time Elapsed** field and validate by pressing  .

NOTE

The Reset Time Elapsed field should be validated with  only when you change the lamp.

When you press the  button, the **Light source Normalization** screen (Figure 26) will be presented.

The Light source Normalization Screen

Stray Light (percent)
Value : 100 %

Figure 26 The Light Source Normalization Screen

The intensity of the light source and consequently the measured signals will decrease over time. After replacing the light source, the signal intensity may also change.

In case your application requires to have constant signal intensities, this option can be used for adjusting the level of the signal intensity. Use either stray light measurements (see “[Background Noise \(Stray Light\) Test](#)” on page 74) or peak areas measured under defined conditions for doing this adjustment.

Example: Your reference measurement gave a stray light value of 120 mV. Your actual stray light measurement gives a value of 140 mV. To re-adjust the Stray Light, use the **Light Source Normalization** screen and enter a value of 85% ($120/140 * 100$), using the \oplus and \ominus buttons then validate by pressing OK . This will result in the stray light re-adjustment.

NOTE

Adjustable range is from 70% to 130%. If the calculated percentage is out of this range, please contact your Agilent service representative.

When you press the ∇ button, the **Gas Valve** screen ([Figure 27](#)) will be presented.

The Gas Valve Screen

Gas Valve: Open
Prog Time 0 mm Off

Figure 27 The **Gas Valve** Screen

The **Gas Valve** screen is used to open/close the gas valve and to setup a program to close the gas valve after a user selected time period. To use this feature, move the cursor to the time field, indicate the appropriate time, then move the cursor to **Off** and use the \oplus or \ominus key to select On and press OK .

When you press the ∇ button, the **External Shutdown** screen ([Figure 28](#)) will be presented.

The Power Down Screen

The **Power Down Mode** screen ([Figure 28](#)) is used to indicate which features should be shut down upon receipt of a power down signal from an external source (e.g. a personal computer or an HPLC pump) or from the menu.



Figure 28 The **Power Down** Screen

The three options provided for external shutdown are summarized in [Table 10](#).

Table 10 **Power Down** Options

Mode	Photomultiplier	LED	Heating	Gas flow
General	Off	Off	Off	Off
Standby	Off	Off	On	Off
Cleaning	Off	Off	On	On

To select the desired **Power Down** mode, use the \oplus or \ominus key to access the desired mode and then press OK to validate the selection.

NOTE

It will take a few minutes to attain operating status from *General* power down mode, as the temperature must stabilize.

Once the **Power Down** mode has been chosen and validated, the detector can be powered down in two ways:

- **External event cable power down contact closure:** The detector will stay in the power down mode chosen while the contact remains closed. It comes back in normal mode when the contact closure is released.
- **Power down screen:** Press the ∇ button to access the power down screen, then press again the ∇ button to place the cursor on the **Power down activate** line. Validate with OK to put the detector in power down mode.

NOTE





To leave the power down mode, release the contact closure if power down has been activated by external event or press any key if power down has been activated from the **Power down** screen.

When the cursor is on the **Power down activate** line, pressing the  button will present the **Date/Time** screen (Figure 29) will be presented.

The Date/Time Screen

Date: 01/05/04
Time: 14:33:21

Figure 29 The **Date Time** Screen

The Date format is MM/DD/YY and the cursor will be in the day field when the screen is accessed. The day can be changed via the  or  key and the next/previous field can be accessed via the  /  key. Press to validate any changes.

When you press the  button, the Total Lifetime Elapsed screen (Figure 30) will be presented.

The Total Lifetime Elapsed Screen

Total Lifetime Elapsed
hrs

Figure 30 The **Total Lifetime Elapsed** Screen

The **Total Lifetime Elapsed** information screen indicates the usage of the detector and cannot be edited. When you press the  button, the **Serial Number** screen (Figure 31) will be presented.

The Serial Number Screen

Serial Number
0380001A

Figure 31 The **Serial Number** Screen

The **Serial Number** screen cannot be edited. When you press the  button, the **Firmware** screen (Figure 32) will be presented.

The Firmware Screen

Firmware Version :	2.1
Firmware Date :	MM/YY

Figure 32 The **Firmware** Screen

This information screen (for detector firmware 2.0 and higher only) presents the firmware version and date, where MM is the month, and YY the year. The Firmware screen cannot be edited.

When you press the  button, the **Factory Method Code** screen ([Figure 33](#)) will be presented.

The Factory Method Code Screen

Factory Method Code _____
Authorized persons only

Figure 33 The **Factory Method Code** Screen

The **Factory Method Code** screen is used by the service engineer to access procedures required for the instrument service.



10 Appendix

Safety Information [108](#)

Solvent Information [112](#)

The Waste Electrical and Electronic Equipment (WEEE) Directive
(2002/96/EC) [113](#)

Lithium Batteries Information [114](#)

Agilent Technologies on Internet [115](#)



Safety Information

The following general safety precautions must be observed during all phases of operation, service, and repair of this instrument. Failure to comply with these precautions or with specific warnings elsewhere in this manual violates safety standards of design, manufacture, and intended use of the instrument. Agilent Technologies assumes no liability for the customer's failure to comply with these requirements.

General

This is a Safety Class I instrument (provided with terminal for protective earthing) and has been manufactured and tested according to international safety standards.

The Agilent 1200 Series modules are designed and certified as a general purpose laboratory instrument for research and routine application only. It is not certified for in-vitro or medical applications.

Operation

Before applying power, comply with the installation section. Additionally the following must be observed.

Before the instrument is switched on, all protective earth terminals, extension cords, auto-transformers, and devices connected to it must be connected to a protective earth via a ground socket. Any interruption of the protective earth grounding will cause a potential shock hazard that could result in serious personal injury. Whenever it is likely that the protection has been impaired, the instrument must be made inoperative and be secured against any intended operation.

The operator of this instrument is advised that if the equipment is used in a manner not specified in this manual, the protection provided by the equipment may be impaired.

Maintain a well ventilated laboratory. If the mobile phase or sample contains volatile substances, ensure that the laboratory is ventilated well such that no flammable or noxious vapors can accumulate.

Do not operate the instrument in the presence of flammable gases or fumes. Operation of any electrical instrument in such an environment constitutes a definite safety hazard.

The exhaust from the detector must be vented into a fume hood, exhaust line or similar installation. Make sure that the exhaust gas does not escape into the laboratory. Take in consideration any solvent filter that could be required by your local environmental laws.

Potential leakage of hazardous liquids: Make sure all flow connections to and inside the detector are tight. After switching on the LC pump, verify that there are no leaks.

Use only inert gases (nitrogen) for nebulizing the mobile phase and samples. Avoid air, oxygen or reactive or inflammable gases in order to avoid the risk of burnings or explosions.

Do not use solvents, which could inflame at temperatures reached by the detector.

Avoid open flames and sparks. Do not use an open flame and do not use any equipment that can cause sparks in the same room as the instrument.

The siphon overflow tube must contain liquid at all times.

When working with solvents please observe appropriate safety procedures (e.g. goggles, safety gloves and protective clothing) as described in the material handling and safety data sheet by the solvent vendor, especially when toxic or hazardous solvents are used.

The gas pressure should not exceed 4.5 bar (67 psi). Make sure that the gas flow is maintained while the mobile phase flows through the system. If the gas flow is interrupted for extended periods of time, organic solvents could possibly damage the pressure sensor and/or the photosensor.

Repair

Do not open the cover of the rear part of this instrument. Access to and repair of internal parts is restricted to Agilent service and service providers authorized by Agilent and certified for this instrument. For internal parts, even if the instrument is grounded, there is a potential shock hazard that could result in serious personal injury.

Make sure that only fuses with the required rated current and of the specified type (normal blow, time delay, and so on) are used for replacement. The use of repaired fuses and the short-circuiting of fuse holders must be avoided.



Do not install substitute parts or make any unauthorized modification to the instrument.

Do not disassemble the nebulizer or touch any components inside the nebulization chamber. This can lead to the deposition of contaminants which could affect the signal.

Safety Symbols

Table 11 shows safety symbols on the instrument:

Table 11 Safety Symbols

Symbol	Description
	Hot surface. Risk of burn.
	Electric shock risk
	The apparatus is marked with this symbol when the user should refer to the instruction manual in order to prevent risk of harm to the operator and to protect the apparatus against damage.

WARNING

A warning alerts you to situations that could cause physical injury or damage to the equipment.

⇒ Do not proceed beyond a warning until you have fully understood and met the indicated conditions.

CAUTION

A caution alerts you to situations that could cause a possible loss of data.

⇒ Do not proceed beyond a caution until you have fully understood and met the indicated conditions.

Solvent Information

Observe the following recommendations on the use of solvents.

Solvents

Brown glass ware can avoid growth of algae. Always filter solvents, small particles can permanently block the capillaries. Avoid the use of the following steel-corrosive solvents:

- Solutions of alkali halides and their respective acids (for example, lithium iodide, potassium chloride, and so on).
- High concentrations of inorganic acids like nitric acid, sulfuric acid especially at higher temperatures (replace, if your chromatography method allows, by phosphoric acid or phosphate buffer which are less corrosive against stainless steel).
- Halogenated solvents or mixtures which form radicals and/or acids, for example:

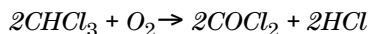

This reaction, in which stainless steel probably acts as a catalyst, occurs quickly with dried chloroform if the drying process removes the stabilizing alcohol.

- Chromatographic grade ethers, which can contain peroxides (for example, THF, dioxane, di-isopropylether) such ethers should be filtered through dry aluminium oxide which adsorbs the peroxides.
- Solutions of organic acids (acetic acid, formic acid, and so on) in organic solvents. For example, a 1-% solution of acetic acid in methanol will attack steel.
- Solutions containing strong complexing agents (for example, EDTA, ethylene diamine tetra-acetic acid).
- Mixtures of carbon tetrachloride with 2-propanol or THF.

The Waste Electrical and Electronic Equipment (WEEE) Directive (2002/96/EC)

Abstract

The Waste Electrical and Electronic Equipment (WEEE) Directive (2002/96/EC), adopted by EU Commission on 13 February 2003, is introducing producer responsibility on all Electric and Electronic appliances from 13 August 2005.

NOTE



This product complies with the WEEE Directive (2002/96/EC) marking requirements. The affixed label indicates that you must not discard this electrical/electronic product in domestic household waste.

Product Category:

With reference to the equipment types in the WEEE Directive Annex I, this product is classed as a “Monitoring and Control instrumentation” product.

Do not dispose off in domestic household waste!

To return unwanted products, contact your local Agilent office, or see www.agilent.com for more information.

Lithium Batteries Information

WARNING

Danger of explosion if battery is incorrectly replaced. Replace only with the same or equivalent type recommended by the equipment manufacturer. Lithium batteries may not be disposed-off into the domestic waste.

Transportation of discharged Lithium batteries through carriers regulated by IATA/ICAO, ADR, RID, IMDG is not allowed. Discharged Lithium batteries shall be disposed off locally according to national waste disposal regulations for batteries.

WARNING

Lithiumbatteri - Eksplosionsfare ved fejlagtig håndtering. Udskiftning må kun ske med batteri af samme fabrikat og type. Lever det brugte batteri tilbage til leverandøren.

WARNING

Lithiumbatteri - Eksplosionsfare. Ved udskiftning benyttes kun batteri som anbefalt av apparatfabrikanten. Brukt batteri returneres apparatleverandøren.

NOTE

Bij dit apparaat zijn batterijen geleverd. Wanneer deze leeg zijn, moet u ze niet weggoien maar inleveren als KCA.

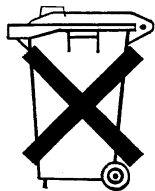

Agilent Technologies on Internet

For the latest information on products and services visit our worldwide web site on the Internet at:

<http://www.agilent.com>

Select **Products > Chemical Analysis**

It will provide also the latest firmware of the Agilent 1200 Series modules for download.

10 Appendix
Agilent Technologies on Internet

Index

A

accessory kit [30, 32](#)
 Auto-zeroing of the Detector [51](#)
 auto-zeroing of the detector [51](#)

B

background noise test [69](#)
 battery
 safety information [114](#)

C

carrying the system [28](#)
 cleaning
 detector [83](#)
 nebulizer [86](#)
 column
 connecting [47](#)
 treatment [63](#)
 column noise [77](#)
 configurations [27](#)
 control panel [96](#)

D

Date/Time screen [105](#)
 decontamination [83](#)
 detection [17](#)
 digital display [97](#)

E

electrical connections [38](#)
 electronic noise [73](#)
 electronic noise test [73](#)
 environmental conditions [23](#)
 evaporation of the solvent [17](#)
 exhaust requirements [22](#)
 external auto-zero [51](#)

F

Factory Method Code [106](#)
 Factory Method Code screen [106](#)
 filter [64](#)
 Firmware [106](#)

G

gas
 considerations [21](#)
 supply [33](#)
 Gas Valve screen [103](#)
 glass tube [45](#)

I

installation [32](#)
 installation test procedure [54](#)
 installing the nebulizer [43](#)
 integrator [40](#)

L

LED screen [102](#)
 lifting the system [28](#)
 location of the detector in the laboratory [23](#)

M

maintenance [81](#)
 manual auto-zeroing [51](#)
 mobile phase (optimizing) [62](#)

N

nebulization [14](#)
 nebulizer
 cleaning [86](#)
 gas [33](#)
 installation [43](#)
 Noise Filter/Pressure Unit [101](#)
 noise tests [69, 71, 73, 74, 75, 77](#)

O

Offset screen [99](#)
 optimizing
 mobile phase [62](#)
 performance [59](#)
 temperature [60](#)

P

power
 cord [38](#)
 requirements [20](#)
 up the detector [47](#)
 Power Down screen [103](#)
 powering down [56](#)
 preparing the system for operation [50](#)
 Pressure Unit (Noise Filter/Pressure Unit screen) [101](#)
 Principle of Operation [12](#)

R

recorder/integrator (connecting) [40](#)
 routine operation [52](#)
 RS-232 port [38](#)

S

safety information [108](#)
 on lithium batteries [114](#)
 safety symbols [110](#)
 sample pre-treatment [62](#)
 screens
 Date/Time [105](#)
 External Power Down [103](#)
 Factory Method Code [106](#)
 Firmware [106](#)
 Gas Valve [103](#)
 LED [102](#)
 Noise Filter/Pressure Unit [101](#)
 Offset [99](#)
 Serial Number [105](#)

- Status 98
- Temperature/Gain 99
- Total Lifetime Elapsed 105
- Serial Number screen 105
- shutting down 56
- siphon overflow (installing) 46
- solvent noise 75
- solvent noise test 75
- start-up
 - kit 27
 - procedure 50
- Status screen 98
- stray light test 74

T

- temperature (optimizing) 60
- Temperature/Gain Screen 99
- Temperature/Gain screen 99
- tests
 - background (stray light) noise 74
- Total Lifetime Elapsed screen 105
- troubleshooting 65

U

- unpacking 30
- user interface 98

V

- venting
 - exhaust lines 37
 - requirements 22

Z

- zeroing the detector 51

www.agilent.com

In This Book

This manual is designed to describe the installation; operation, maintenance and basic troubleshooting of the G4218A Agilent Evaporative Light Scattering Detector. It includes:

- Introduction
- Installation of the Detector
- Start-Up Procedure
- Operating the System
- Maintenance and Troubleshooting
- Specifications
- Spare Parts List
- Electrical connections
- Safety Information

© Agilent Technologies 2008, 2009

Printed in Germany
12/2009



G4218-90001



Agilent Technologies