

General Lab Products



Reliable Performance

Centrifuge 5804/5804 R and Centrifuge 5810/5810 R



Introducing the Eppendorf 58xx Centrifuge Family

Reliable performance

The Eppendorf approach to product development is, and always has been, about giving you more. More quality, more innovation. All of our centrifuges personalize this philosophy.

They all go beyond speed and capacity to offer you unparalleled ergonomic operation, excellent temperature control, and outstanding product quality. Each centrifuge is

designed to operate at low noise levels for a relaxing work environment and offers soft-touch lid closure for ease of use and a low profile for easy loading and unloading of samples.

Refrigerated centrifuge models have exclusive features such as ECO shut-off and dynamic compressor control for maximum sample protection and energy savings.

The Benchmark in Ergonomic Operation

Low profile for easy operation

The 58xx centrifuges are designed with a particularly low height in mind. Not only does the low profile facilitate easy loading and unloading, it also allows everyone in the lab to easily reach the open centrifuge lid.



Soft-touch lid closure

There's no need to exert unnecessary high force when closing the centrifuge lid. The soft-touch lid closure allows closing the centrifuge with ease.



Eppendorf QuickLock® caps for one-hand operation

Aerosol-tight caps provide the needed safety when working with potentially hazardous samples. The caps for the 4 × 750 mL swing-bucket rotor allow for easy, one-handed operation. Its unique design allows the closed bucket to be carried securely to the biosafety cabinet.



Eppendorf QuickLock® rotor lids for ergonomic lid locking

Our aerosol-tight QuickLock rotors close with only ¼ of a turn. This not only saves you time during every day use, it also takes repetitive stress off your wrist.



Centrifuge 5804/5804 R



Centrifuge 5804 with plate rotor A-2-DWP

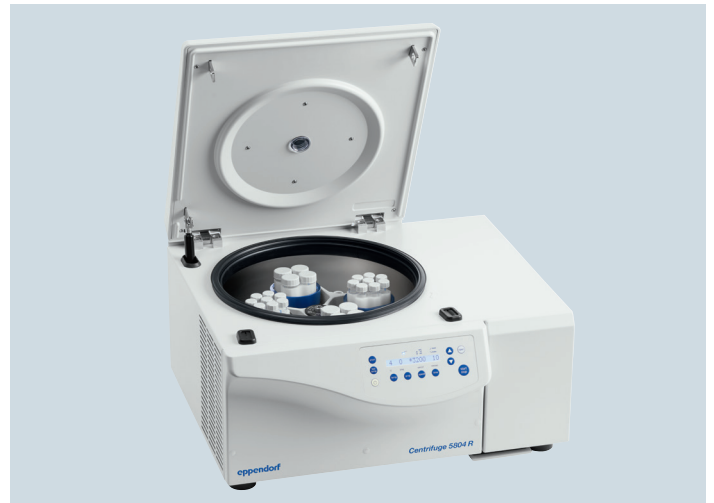

Centrifuge 5804 R with rotor S-4-72 (4 x 250 mL)

The Centrifuge 5804/5804 R is a high speed centrifuge for medium capacity needs. It allows for applications in tubes up to 250 mL and offers additional swing-bucket and fixed-angle rotors as well as deepwell plate capacity for increased versatility. Common rotors for Centrifuge 5804/5804 R include:



S-4-72
4 x 250 mL swing-bucket rotor.
Max. speed 3,234 x g (4,200 rpm).

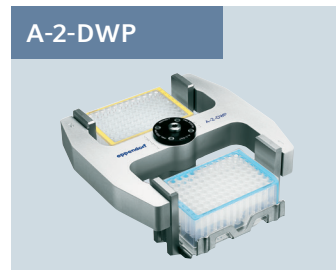

A-2-DWP
2-place deepwell plate rotor
for plates up to 89 mm
loading height. Max. speed
2,250 x g (3,750 rpm).



FA-45-6-30
6 x 50 mL conical tube rotor with
aerosol-tight QuickLock lid for
tubes from 5–50 mL. Max. speed
16,639 x g (11,000 rpm).



FA-45-30-11
30 x 1.5/2 mL micro tube rotor
with aerosol-tight lid for safe
centrifugation of hazardous
samples. Max. speed 20,800 x g
(14,000 rpm).

Eppendorf recognizes its responsibility as a global citizen. Protecting the environment is critical to the conservation of precious natural resources. The Eppendorf epGreen® initiative is another example of our commitment to social responsibility. Our goal is to constantly reduce the environmental impact of our business operations and the products that we produce.

Centrifuges in general

- > Use of brushless induction motors to provide maintenance-free operation, eliminating carbon particle emissions
- > Rotors are mostly made of recyclable aluminum
- > Optimized sound design for low noise levels to benefit your work environment
- > 100 % recyclable packaging material

Centrifuge 5810/5810 R

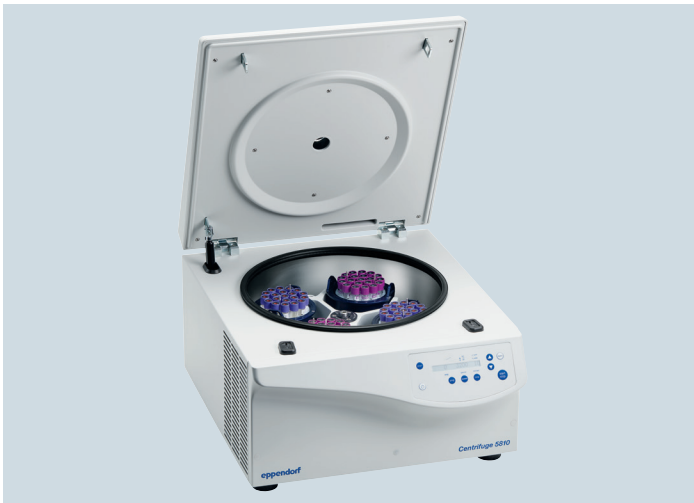

Centrifuge 5810 with rotor S-4-104 (4 × 750 mL)

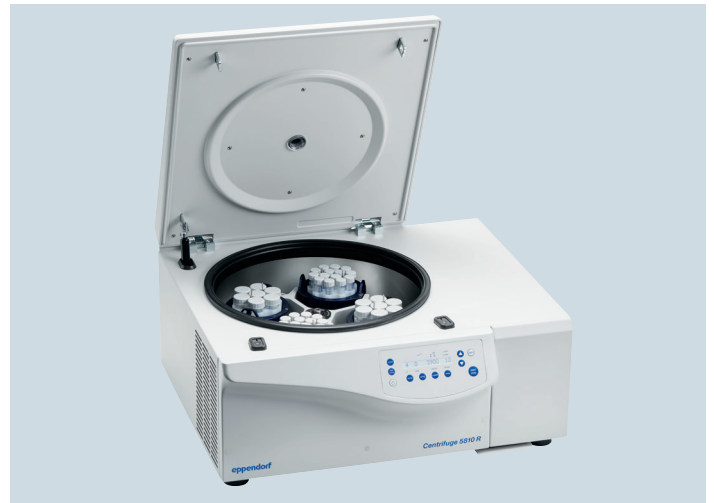

Centrifuge 5810 R with rotor S-4-104 (4 × 750 mL)

The Centrifuge 5810/5810 R is a workhorse for medium to high-throughput laboratories. It combines high versatility and capacity for both tubes and plates with an extraordinary compact footprint. Common rotors for Centrifuge 5810/5810 R include:

S-4-104



4 × 750 mL swing-bucket rotor with optional aerosol-tight QuickLock caps. Max. speed 3,214 × *g* (3,900 rpm).

Rotor S-4-104 is also available with plate buckets and optional aerosol-tight QuickLock caps.

FA-45-6-30



6 × 50 mL conical tube rotor with aerosol-tight QuickLock lid for tubes from 5–50 mL. Max. speed 20,130 × *g* (12,000 rpm).

FA-45-48-11



48 × 1.5/2 mL micro tube rotor with aerosol-tight QuickLock rotor lid for safe centrifugation of hazardous samples. Max. speed 19,083 × *g* (13,000 rpm).

Refrigerated models additionally feature

- > Dynamic compressor control for precise cooling performance
- > CFC-free refrigerant with an ozone depletion potential (ODP) of zero
- > ECO shut-off deactivates the compressor after 8 hours of inactivity to reduce energy consumption and extend compressor life

Energy saving through 2nd generation of swing-bucket rotors*

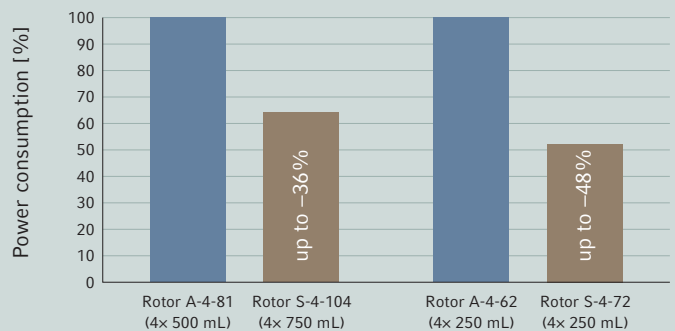

* based on internal testing with Centrifuge 5810 R, 230 V

Performance You Can Count On

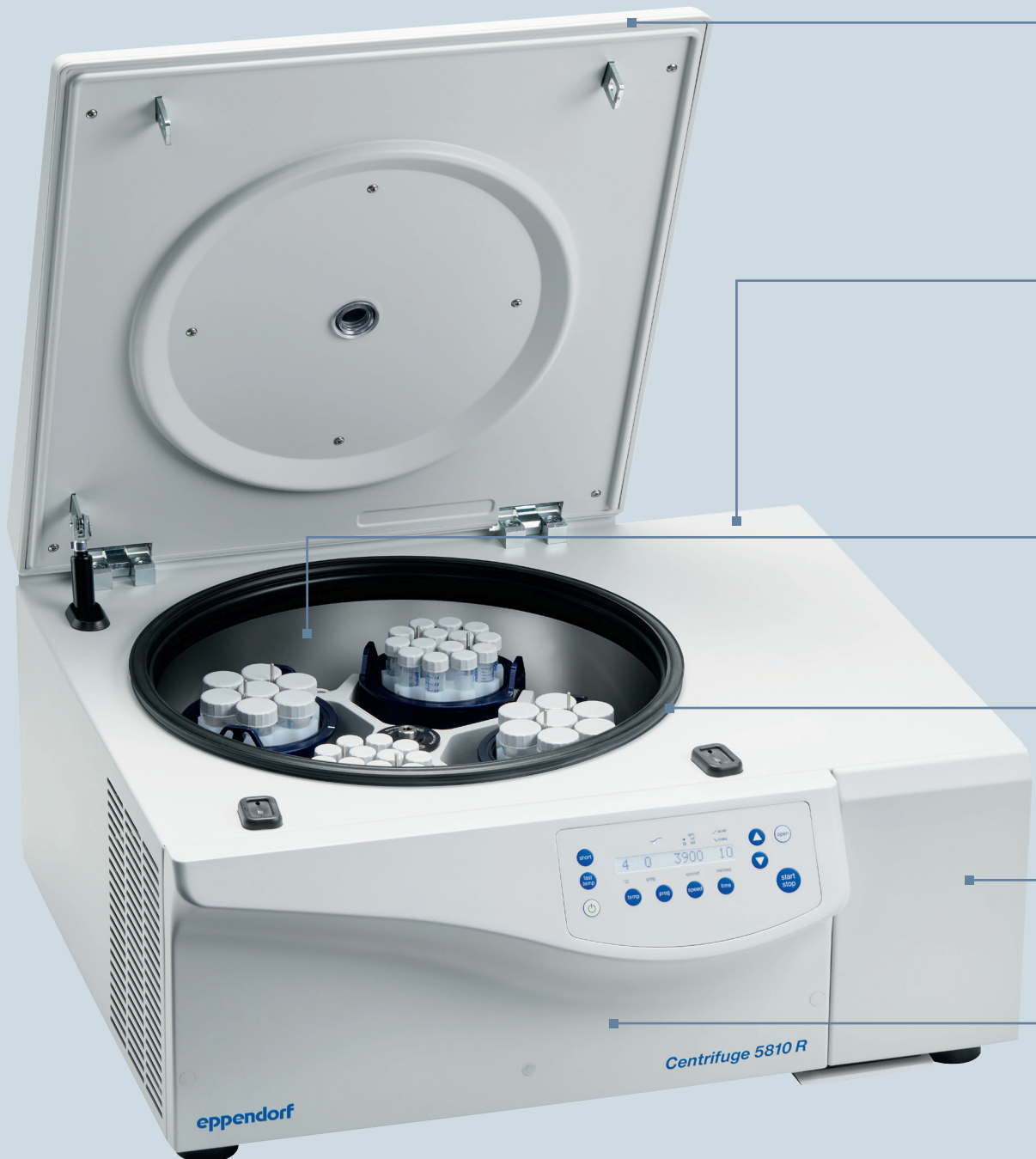

Ergonomic lid operation

- > Soft-touch lid closure and low opening height for stress-free lid locking

Precise cooling performance

- > Dynamic compressor control with ECO shut-off function

Mixed loading capability

- > Rotors S-4-104 and A-4-81 provide mixed loading capability with plate and tube buckets for increased versatility

Quiet operation

- > All models are designed to operate at low noise levels for a relaxing work environment

Low access height (29 cm)

- > Easy loading/unloading of samples

Placement flexibility

- > Compact footprint
- > Low opening height for use under shelves
- > Rolling cabinet option available for use in crowded labs

Outstanding versatility for all your applications

- > Broad rotor and adapter selection to spin all commonly used tubes, bottles, flasks, and plates
- > High centrifugation speed up to $20,913 \times g$ (14,000 rpm) for applications in tubes and bottles from 0.2 to 750 mL
- > Aerosol-tight rotors (e.g. for potentially hazardous materials)

The benchmark for ergonomic operation

- > Low sound level to benefit your work environment
- > Low access height (29 cm) for easy loading/unloading
- > Centrifuge lid with soft-touch lid closure

Designed to fit in every lab

- > Compact footprint saves valuable bench space
- > Low lid opening height for use under shelves
- > Automatic rotor recognition and imbalance detection for maximum operational safety

Advanced temperature management for maximum sample protection and energy efficiency

- > Temperature range from $-9\text{ }^{\circ}\text{C}$ to $40\text{ }^{\circ}\text{C}$
- > Maintains constant $4\text{ }^{\circ}\text{C}$, even at maximum speed (rotors F-34-6-38 and FA-45-6-30 maintain $4\text{ }^{\circ}\text{C}$ at 11,000 rpm)
- > FastTemp function for quick pre-cooling
- > Continuous cooling maintains a constant temperature after the run has been completed - your samples stay cool
- > ECO shut-off engages after 8 hours of non-use to reduce energy consumption and extend compressor life
- > Dynamic compressor control (DCC) technology for precise cooling performance

Rotor Design at Its Best

Eppendorf's 2nd generation of swing-bucket and fixed-angle rotors elevate your centrifuge performance to a new level. Enjoy unique product features that improve handling and performance.

Swing-bucket rotors

Improved energy efficiency

The round buckets have been designed to be especially aerodynamic. The result is a more efficient design that reduces power consumption by up to 48 %.

Longer rotor lifetime

The 2nd rotor generation of both swing-bucket and fixed-angle rotors has been designed with a particularly long lifetime in mind.

Eppendorf QuickLock® caps for one-hand operation

- > Significantly improved handling, easy operation with one hand
- > Handle allows the closed bucket to be carried to the biosafety cabinet where it can be opened in a safe environment
- > Aerosol-tightness has been tested and verified by Public Health England, Porton Down, UK



Fixed-angle rotors

Low rotor weight

Eppendorf's fixed-angle rotors are among the lightest in the industry to improve handling and operational safety. Light-weight rotors cause less wear and tear on the motor and allow for faster acceleration and braking times.

Eppendorf QuickLock® lids for ergonomic lid locking

Our aerosol-tight QuickLock rotors close with only $\frac{1}{4}$ of a turn. This not only saves you time during every day use, it also takes repetitive stress off your wrist.

Superior temperature control

Aluminum, with its high heat conductivity, allows fast pre-cooling and accurate temperature control in refrigerated centrifuges.

Additional rotor features

- > All rotors are anodized for high chemical resistance and to prevent corrosion
- > Optimized design of rotor boreholes and adapters provide optimal support for high-speed centrifugation of tubes
- > Aluminum rotors are recyclable







Cross section of Rotor FA-45-6-30

(6 × 50 mL conical) showing the light-weight design.

All metal not needed for safety or performance is hollowed out to reduce weight and improve handling.

Exceptional Versatility

Overview of the main rotors

Rotor image					
					
Rotor name	S-4-104 (4 × 750 mL) aerosol-tight QuickLock caps	A-4-81 (4 × 500 mL) aerosol-tight	A-4-62 (4 × 250 mL) aerosol-tight	S-4-72 (4 × 250 mL)	A-4-44 (4 × 100 mL) aerosol-tight
5804/ 5804 R				x	x
5810/ 5810 R	x	x	x	x	x
Description	High-capacity swing-bucket rotor	Medium to high capacity swing-bucket rotor	Economic swing-bucket rotor for medium capacity	Economic swing-bucket rotor for medium capacity	High-speed swing-bucket rotor
Aerosol-tightness	yes	yes	yes	no	yes
Max. speed (RCF)	3,214	3,220	3,220	3,234	4,500
Max. speed (rpm)	3,900	4,000	4,000	4,200	5,000
Volume range	0.2–750 mL MTP/DWP	0.2–500 mL, MTP/DWP	0.2–250 mL, MTP/DWP	0.2–250 mL	0.2–100 mL
Eppendorf Tubes® 5.0 mL and 15 mL conical	56	48	36	32	16
50 mL conical	28	20/28*1	16	16	4/8*1
13 mm blood tube	92	100	60	56	36
16 mm blood tube	80	64	48	52	28
1.5/2.0 mL micro tube	200	96	64	104	48
MTP	16	16	12		
DWP	4	4	4		

*1 Maximum capacity with dedicated 50 mL bucket.



epServices
for premium performance

Centrifuge Performance Plans

An annual inspection and maintenance of centrifuges and rotors by an Eppendorf certified service technician is highly recommended to ensure a safe working environment.

■ ESSENTIAL CHECK





> Check of all fundamental functions of the product

■ ADVANCED MAINTENANCE

> Preventive maintenance service to meet manufacturer specifications

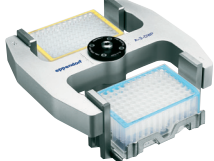
■ PREMIUM SERVICE

> Complete maintenance and repair service agreement solution for your peace of mind

				
A-2-DWP-AT (2 × 4 MTP) aerosol-tight	A-2-DWP (2 × 4 MTP)	F-34-6-38 (6 × 85 mL)	FA-45-6-30 (6 × 50 mL) aerosol-tight QuickLock lid	FA-45-48-11 (48 × 2 mL) aerosol-tight QuickLock lid
	x	x	x	x
x	x	x	x	x
Aerosol-tight deepwell plate rotor for safe centrifugation of hazardous samples.	Economic deepwell plate rotor	High-speed rotor suitable for molecular biology applications in tubes up to 85 mL	Aerosol-tight high-speed rotor for safe centrifugation of hazardous samples	Aerosol-tight microcentrifuge tube rotor for safe centrifugation of hazardous samples
yes	no	no	yes	yes
3,486	2,250	18,500/15,500*2	20,130/16,639*2	19,083
4,500	3,700	12,000/11,000*2	12,100/11,000*2	13,000
MTP/DWP	MTP/DWP	0.2–85 mL	5–50 mL	0.2–2.0 mL
		6	6	
		6	6	
		18	6	
		12	6	
		24		48
8	8			
2	2			

*2 Max. speed in Centrifuge 5810 R, lower speed applies to Centrifuge 5804/5804R/5810.

Certification Services

Our Installation Qualification (IQ) and Operational Qualification (OQ) services make sure that temperature accuracy, rotational speed verification and operating time meet manufacturer's specifications.

Over the years, all rotor structures will eventually suffer from fatigue due to stress of high numbers of cycles. If not maintained correctly, surface scratches can lead to microscopic and then to critical cracks. Qualified inspection will detect damages early in order to prevent further equipment failure. Our service includes cleaning, instructions for proper care, and visual examination of rotors and adapters

determining if the rotor is safe for further operation or needs to be replaced.

The Performance Plans feature

- > Manufacturer-specific test procedures
- > GLP supporting documentation

Value of service

- > Highest degree of security in your lab
- > Longer service life of the system

> Further information and local offers in your country: www.eppendorf.com/epServices

Rotor S-4-104



Product features

- > High capacity swing-bucket rotor with max. speed $3,214 \times g$ (3,900 rpm)
- > Rotor S-4-104 accommodates tubes and bottles from 0.2 mL to 750 mL as well as plates
- > Aerodynamic round bucket design for up to 36 % energy savings compared to Rotor A-4-81
- > Mixed loading with 2 plate buckets and 2 round tube buckets allows for increased versatility
- > Aerosol-tight Eppendorf QuickLock caps for safe centrifugation of hazardous samples optionally available*¹
- > Rotor life time: max. 100,000 cycles
- > Buckets, caps, and adapters are autoclavable



Tube

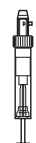
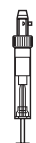

Tube capacity (mL)	1.5/2.0	12 x 75 mm, 5 mL FACS	2.6–8	5.5–12	9	14
Max. tube diameter (Ø mm)	11	12	13	16	17.5	17.5
Max. vessel height (mm)	39	115	115	119	111	117
Max. vessel height for use with aerosol-tight lid (mm)* ²	39	108	108	114	106	112
Adapter/bucket options for Rotor S-4-104						
Capacity per bucket/rotor	50/200	27/108	23/92	20/80	20/80	14/56
Adapter bottom shape	flat	round	round	round	round	round
Centrifugation radius (mm)	188	175	179	180	179	185
Max. RCF (g-force)	3,197	3,112	3,044	3,061	3,044	3,146
Order no. (set of 2)	5825 740 009	5825 747 003	5825 738 004	5825 736 001	5825 743 008	5825 748 000

*¹ Aerosol-tightness tested by Public Health England, Porton Down, UK.

*² Exceeding the maximum tube length may reduce the loading capacity of the rotor. Please perform a manual swing-out test before starting the centrifuge run to make sure the tubes do not hit the rotor yoke.

*³ Please note that these conical bottles need to be used together with a conical form insert provided by the manufacturer.

*⁴ Available as a set of 2 bottles (see ordering information).

*⁵ Please note that a software upgrade may be necessary for older centrifuges when using Rotor S-4-104.











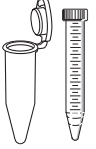

Please contact your local Eppendorf organization or dealer for further information

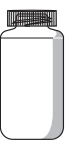
Ordering information

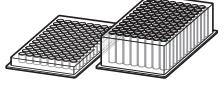
Description	Order no.
Rotor S-4-104*5	
Rotor S-4-104, incl. 4 × 750 mL round buckets	5820 740 000
Rotor S-4-104, incl. 4 × Plate bucket (aerosol-tight capable)	5820 754 001
Rotor S-4-104, without buckets	5820 755 008
Buckets for Rotor S-4-104*5	
Plate bucket (aerosol-tight capable), incl. plate carrier, set of 4	5820 743 000
Plate bucket (aerosol-tight capable), incl. plate carrier, set of 2	5820 744 006

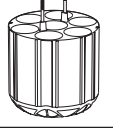
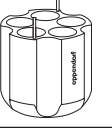
Accessories

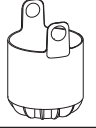
Aerosol-tight caps*1, for 750 mL round buckets, set of 2	5820 747 005
Aerosol-tight caps*1, for Plate bucket (aerosol-tight capable), set of 2	5820 748 001
750 mL wide-mouth bottle, set of 2	5820 708 000

								
Eppendorf Tubes® 5.0 mL and 15 mL conical	30 mL	50 mL conical	50 mL conical skirted	175– 225 mL conical, Nunc® 250 mL conical	250 mL flat	500 mL Corning®	750 mL Eppendorf bottle*4 (order no. 5820 708.000)	MTP, DWP, PCR plates
17	25	30	30	*3	62	96	102	–
125	111	122	120		145	147	140	60
121	106	116	116		125	–	–	47
								
14/56	8/32	7/28	5/20	1/4	1/4	1/4	4/16 (MTP) 1/4 (DWP)	
conical	flat	conical	conical, skirted	flat	conical	flat	flat	
188	174	187	178	183	187	185	151	
3,197	2,958	3,180	3,027	3,112	3,146	3,146	2,568	
5825 734 009	5825 755 006	5825 733 002	5825 732 006	5825 741 005	5825 745 000	5825 744 004	5820 744 006	

Rotor A-4-81







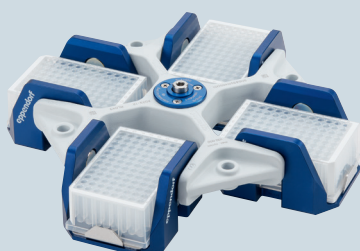
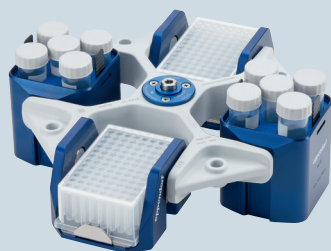

Product features

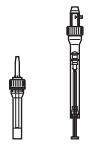
- > Swing-bucket rotor with max. speed $3,220 \times g$ (4,000 rpm)
- > Rotor A-4-81 accommodates tubes and flasks from 0.2 mL to 500 mL as well as plates
- > Aerosol-tight caps*¹ for safe centrifugation of hazardous samples optionally available
- > Mixed loading with 2 plate buckets and 2 rectangular tube buckets allows for increased versatility
- > Rotor life time: max. 100,000 cycles
- > Buckets, caps, and adapters are autoclavable

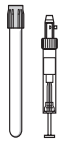
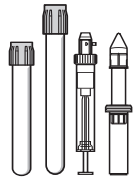
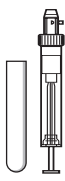
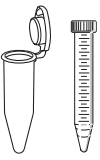

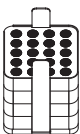
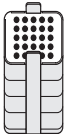
Tube

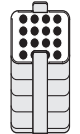
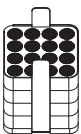
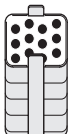
							
Tube capacity (mL)	1.5/2	1.2-5	2.6-5	2.6-7	3-15	7-17	Eppendorf Tubes [®] 5.0 mL and 15 mL conical
Max. tube diameter (Ø mm)	11	11	13	13	16	17.5	17
Max. vessel height (mm)*²	143	108	108	108	108 (130 mm in 2 inner rows)* ²	118 (130 mm in 2 inner rows)* ²	121
Max. vessel height for use with aerosol-tight lid*¹ (mm)	143	108	108	108	108 (130 mm in 4 center pos.)* ²	118 (130 mm in 4 center pos.)* ²	121
Adapter/bucket options for Rotor A-4-81							
Capacity per bucket/rotor	20/80	20/80	25/100	18/72	16/64	16/64	12/48
Adapter bottom shape	flat	flat with rubber mat	flat with rubber mat	flat with rubber mat	flat with rubber mat	flat with rubber mat	conical
Centrifugation radius (cm)	16.5	16.8	16.8	16.8	16.8	16.8	17.3
Max. RCF (g-force)	2,950	3,000	3,000	3,000	3,000	3,000	3,100
Order no. (set of 2)	5810 745 004	5810 746 000	5810 720 001	5810 747 007	5810 748 003	5810 721 008	5810 722 004

*¹ Aerosol-tightness tested by Public Health England, Porton Down, UK.

*² Exceeding the maximum tube length may reduce the loading capacity of the rotor.

Please perform a manual swing-out test before starting the centrifuge run to make sure the tubes do not hit the rotor yoke.









** Only Centriprep[®] tube without locking lid.



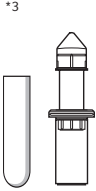
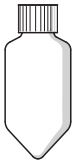

Ordering information

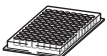
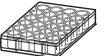
Description	Order no
Rotor A-4-81	
Rotor A-4-81, incl 4 × 500 mL rectangular buckets	5810 718 007
Rotor A-4-81, incl 4 × MTP/Flex plate buckets	5810 725 003
Rotor A-4-81 without buckets	5810 743 001
Buckets for Rotor A-4-81	
Bucket, 500 mL rectangular, set of 4	5810 730 007
Bucket, 7 × 50 mL conical, set of 4	5825 730 003
Bucket, MTP/Flex plates, set of 2	5810 742 005
Bucket, MTP/Flex plates, set of 4	5810 741 009

Accessories

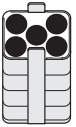
Aerosol-tight cap ² for 500 mL rectangular bucket, set of 2	5810 724 007
Bottle 400 mL wide-mouth, includes stabilizing sleeves, set of 2	5810 729 009
Bottle 500 mL wide-mouth, set of 2	5820 707 003

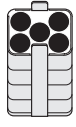
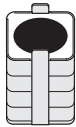
									
50 mL conical	50 mL conical, skirted	30–50 mL and 50 mL Centriprep [®]	175–225 conical	180–250 flat	400 mL bottle* ⁵ (5810 729.009)	500 mL bottle* ⁵ (5820 707.003)	MTP and PCR plates	Cell culture plates	DWP
30	31	29	62	62	62	83	–	–	–
122	119	122	133	133	133	134	60	60	60
116	–	–	116	–	–	134	–	–	–

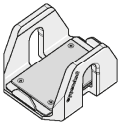
					no adapter needed	
5/20	7/28	5/20	1/4	1/4	1/4	See page 23 for additional adapters
conical	conical	flat with rubber mat	flat with rubber mat	flat, rubber	–	flat with rubber mat
17.3	18.0	17.3	17.3	18.0	18.0	16.3
3,100	3,250	3,100	3,100	3,220	3,220	2,900
5810 723 000	5825 730 003* ⁷	5810 739 004	5825 722 000	5810 728 002	–	5810 742 005 5810 741 009* ⁶

*⁶ Please note that these conical flasks need to be used together with a conical form insert provided by the flask manufacturer.
*⁷ Available as a set of 2 flasks (see ordering information).





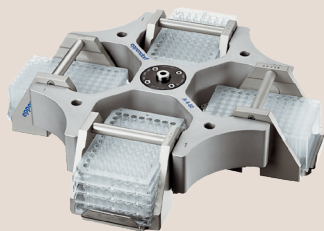



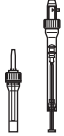
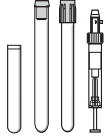
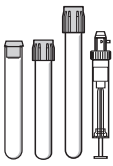
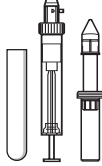
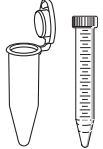

*⁵ Set of 4.
*⁸ 50 mL conical tubes skirted need to be ordered separately. Order no. 5804 737.008 (set of 8).

Rotor A-4-62

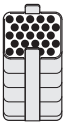

Product features

- > Economic swing-bucket rotor with speed up to $3,220 \times g$ (4,000 rpm)
- > Rotor A-4-62 accommodates tubes and flasks from 0.2 mL to 250 mL as well as plates
- > Aerosol-tight caps*¹ for safe centrifugation of hazardous samples optionally available
- > Rotor life time: max. 40,000 cycles
- > Rotor, buckets, caps, and adapters are autoclavable

Tube								
Tube capacity (mL)	1.5/2	1.2-5	1.8-7	3-15	7-17	Eppendorf Tube® 5.0 mL and 15 mL conical	7-18	18-30
Max. tube diameter (Ø mm)	11	11	13	16	17.5	17	20	26
Max. vessel height (mm)* ²	143	123	121	121 (130 mm in 2 center rows)* ²	118 (130 mm in 2 center rows)* ²	127	126	119
Max. vessel height for use with aerosol-tight lid* ¹ (mm)	143	115	118	116 (130 mm in 2 inner pos.)	114 (130 mm in 2 inner pos.)	121	119	116
Adapter/bucket options for Rotor A-4-62								
Capacity per bucket/rotor	16/64	25/100	15/60	12/48	12/48	9/36	8/32	4/16
Adapter bottom shape	flat	flat with rubber mat	flat with rubber mat	flat with rubber mat	flat with rubber mat	conical	flat with rubber mat	flat with rubber mat
Centrifugation radius (cm)	17.1	17.3	17.3	17.3	17.3	17.8	17.3	17.3
Max. RCF (g-force)	3,000	3,050	3,050	3,050	3,050	3,150	3,050	3,050
Order no. (set of 2)	5810 751 004	5810 750 008	5810 752 000	5810 753 007	5810 754 003	5810 755 000	5810 756 006	5810 757 002





*¹ Aerosol-tightness tested by the Centre for Public Health England, Porton Down, UK.





*² Exceeding the maximum tube length may reduce the loading capacity of the rotor. Please perform a manual swing-out test before starting the centrifuge run to make sure the tubes do not hit the rotor yoke.

*³ For high g-forces we recommend using centrifuge tubes of Duran® glass.

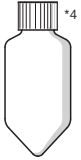
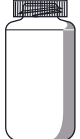
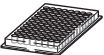
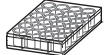
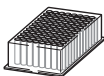
Ordering information

Description	Order no.
Rotor A-4-62	
Rotor A-4-62, incl. 4 × 250 mL rectangular buckets	5810 709 008
Rotor A-4-62, incl. 4 × MTP plate buckets	5810 711 002
Buckets for Rotor A-4-62	
Bucket, 250 mL rectangular, set of 4	5810 716 004
Bucket, MTP plates, set of 4	5810 702 003
Accessories	
Aerosol-tight cap*1 for 250 mL rectangular bucket, set of 2	5810 710 006

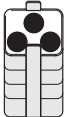
									
30-50	50 mL conical, skirted	50 mL conical	50-75	80-120	175-225 conical	180-250	MTP and PCR plates	Cell culture plates	DWP
30	30	30	35	45	62	—	—	—	—
115	115	122	122	138	136	53	53	53	—
113	113	—	116	118	125	—	—	—	—

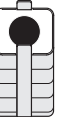
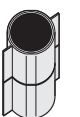
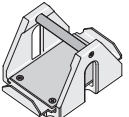
									
5804 737.008						See page 23 for additional adapters			
4/16	4/16	3/12	2/8	1/4	1/4	4/16	2/8	1/4	
flat with rubber mat	flat w/conical form insert	conical	flat with rubber mat	flat with rubber mat	flat with rubber mat	flat with rubber mat			
17.3	17.3	17.8	17.3	17.3	18.0	15.4			
3,050	3,050	3,150	3,050	3,050	3,200	2,750			
5810 759 005	5810 763 002	5810 758 009	5810 760 003	5810 761 000	5810 770 009	5810 702 003*6			

*4 Please note that these conical flasks need to be used together with a conical form insert provided by the manufacturer.

*5 Form inserts for 50 mL conical tubes skirted need to be ordered separately. Order no. 5804 737.008 (set of 8).







*6 Set of 4.

Rotor S-4-72

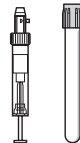
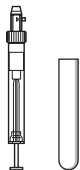

Product features

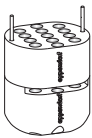
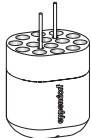
- > Medium capacity swing-bucket rotor with speed up to $3,234 \times g$ (4,200 rpm)
- > Broad range of adapters available to handle all common tube formats from 0.2 mL to 250 mL
- > Aerodynamic round bucket design for up to 48% energy savings compared to Rotor A-4-62
- > Rotor life time: max. 60,000 cycles
- > Buckets and adapters are autoclavable

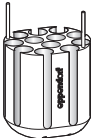
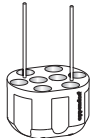
Tube					
Tube capacity (mL)	1.5/2.0	2.6–8 mL	5.5–12	9	Eppendorf Tubes® 5.0 mL
Max. tube diameter (Ø mm)	11	13	16	17.5	17
Max. vessel height (mm)*1	43	115	112	113	60
Max. vessel height for use with aerosol-tight lid*1 (mm)	–	–	–	–	–
Adapter options for Rotor S-4-72					
Capacity per bucket/rotor	26/104	14/56	13/52	12/48	8/32
Adapter bottom shape	flat	round	round	round	conical
Centrifugation radius (mm)	159	159	157	158	163
Max. RCF (g-force)	3,136	3,136	3,096	3,116	3,215
Order no. (set of 2)	5804 794 001	5804 789 008	5804 791 002	5804 792 009	5804 793 005

*1 Exceeding the maximum tube length may reduce the loading capacity of the rotor.





*2 Please note that these conical flasks need to be used together with a conical form insert provided by the flask manufacturer.

*3 Please note that a software upgrade may be necessary for older centrifuges when using Rotor S-4-72.

Please contact your local Eppendorf organization or dealer for further information

Ordering information

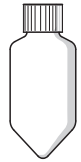
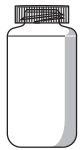
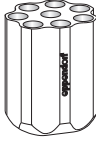
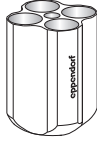
Description	Order no.
Rotor S-4-72*3, incl. 4 × 250 mL round buckets	5804 746 007





				
15 mL conical	50 mL conical	50 mL conical skirted	175-225 conical*2	250 mL flat
17	31	31		62
120	120	120		130
-	-	-		-
				
8/32 conical	4/16 conical	2/8 flat		1/4 flat
164	164	153		161
3,234	3,234	3,017		3,175
5804 783 000	5804 784 006	5804 785 002		5804 787 005

Rotor A-4-44

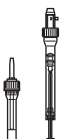
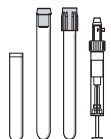
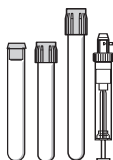
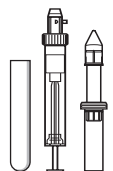
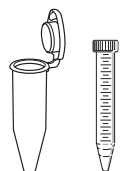

Product features

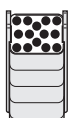
- > High-speed swing-bucket rotor for applications up to $4,500 \times g$ (5,000 rpm)
- > Rotor A-4-44 accommodates tubes from 0.2 mL to 100 mL
- > Aerosol-tight caps*¹ for safe centrifugation of hazardous samples optionally available
- > Rotor life time: max. 34,000 cycles
- > Rotor, buckets, caps, and adapters are autoclavable

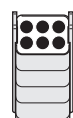
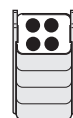
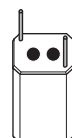
Tube							
Tube capacity (mL)	1.5/2	1.2-5	2.6-7	3-15	7-17	Eppendorf Tubes® 5.0 mL and 15 mL conical	
Max. tube diameter (Ø mm)	11	11	13	16	17.5	17	
Max. vessel height (mm)* ²	143	105	108	108	110	121	
Max. vessel height for use with aerosol-tight lid* ¹ (mm)	143	102	106	106	106	- 121	
Adapter/bucket options for Rotor A-4-44							
Capacity per bucket/rotor	12/48	14/56	9/36	7/28	6/24	4/16	2/8
Adapter bottom shape	flat	flat with rubber mat	flat with rubber mat	flat with rubber mat	flat with rubber mat	conical	conical
Centrifugation radius (cm)	14.8	15.0	15.0	15.0	15.0	15.5	15.7
Max. RCF (g-force)	4,100	4,200	4,200	4,200	4,200	4,300	4,400
Order no. (set of 2)	5804 751 000	5804 750 004	5804 752 007	5804 753 003	5804 754 000	5804 755 006	5804 717 007

*¹Aerosol-tightness tested by Public Health England, Porton Down, UK.

*²Exceeding the maximum tube length may reduce the loading capacity of the rotor. Please perform a manual swing-out test before starting the centrifuge run to make sure the tubes do not hit the rotor yoke.

*¹For high g-forces we recommend using centrifuge tubes of Duran® glass.

*²Reordering of 50 mL form inserts: 5804 728.009.















*³Max. load per bucket: 140 grams.

*⁴Set of 4.

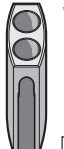
*⁵Form inserts for 50 mL conical tubes skirted need to be ordered separately. Order no. 5804 737.008 (set of 8).

Ordering information

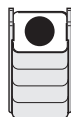
Description	Order no
Rotor A-4-44	
Rotor A-4-44, incl 4 × 100 mL rectangular buckets	5804 709 004
Rotor A-4-44, incl four 2 × 50 mL buckets	5804 719 000
Buckets for Rotor A-4-44	
Bucket, 100 mL rectangular, set of 4	5804 741 005
Bucket, 2 × 50 mL, set of 4	5804 706 005
Accessories	
Aerosol-tight cap*1 for 100 mL rectangular bucket, set of 2	5804 712 005

							
*3	*3			*3	*3	*3	
7–18	18–30	50 mL conical	50 mL conical, skirted	30–50	50–75	80–100	
20	26	30	31	31	35	45	
107	110	122	122	122	119	114	
104	100	–	–	119	108	108	108
							
4/16	2/8	2/8	1/4	1/4	5804 737.008	1/4	1/4
flat with rubber mat	flat with rubber mat	flat w/conical form insert*6	conical	conical	flat with rubber mat	flat with rubber mat	flat with rubber mat
15.0	15.0	16.1	15.5	15.7	15.0	15.0	15.0
4,200	4,200	4,500	4,300	4,400	4,200	4,200	4,200
5804 756 002	5804 757 009	5804 706 005*6	5804 758 005	5804 718 003	5804 759 001	5804 760 000	5804 761 006

Rotor A-2-DWP-AT and A-2-DWP

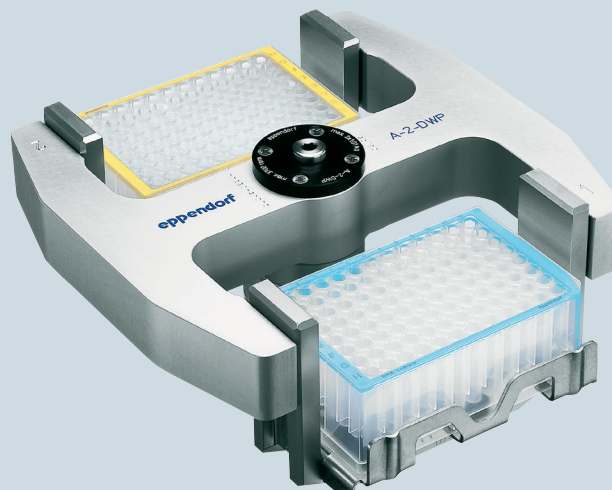

Aerosol-tight*¹ deepwell plate Rotor A-2-DWP-AT*²

- > For use in Centrifuge 5810/5810 R only
- > Max. speed: 3,486 × g (4,500 rpm)
- > Rotor can handle up to
 - 2 × 4 MTP
 - 2 × 1 DWP
 - 2 × 1 Filtration plate kits
- > Maximum loading height of 67 mm (89 mm without lid)
- > Rotor comes with aerosol-tight caps*¹ for safe centrifugation of hazardous samples
- > Rotor and buckets are autoclavable

Deepwell plate Rotor A-2-DWP

- > For use in Centrifuge 5804/5804 R and 5810/5810 R
- > Max. speed: 2,250 × g (3,700 rpm)
- > Rotor can handle up to
 - 2 × 4 MTP
 - 2 × 4 Cell culture plates
 - 2 × 2 DWP
 - 2 × 1 Filtration plate kits
- > Maximum loading height of 89 mm
- > Rotor and buckets are autoclavable

Ordering information

Description	Order no
Aerosol-tight deepwell plate Rotor A-2-DWP-AT*²	
Rotor A-2-DWP-AT, incl buckets, aerosol-tight caps and plate carrier	5820 710 004
Deepwell plate Rotor A-2-DWP	
Rotor A-2-DWP, incl 2 deepwell plate buckets	5804 740 009

*¹ Aerosol-tightness is tested and certified by Public Health England, Porton Down, UK

*² Please note that a software upgrade may be necessary for older centrifuges when using Rotor A-2-DWP-AT
Please contact your local Eppendorf organization or dealer for further information

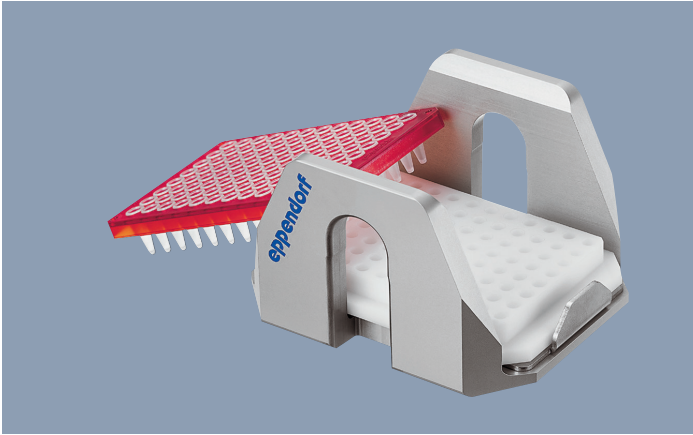

PCR plate adapter (PCR 96)

- > PCR plate adapters are designed to support thin-walled PCR plate wells during centrifugation
- > Available for 96-well and 384-well PCR plates
- > Adapters can be used in all Eppendorf plate rotors

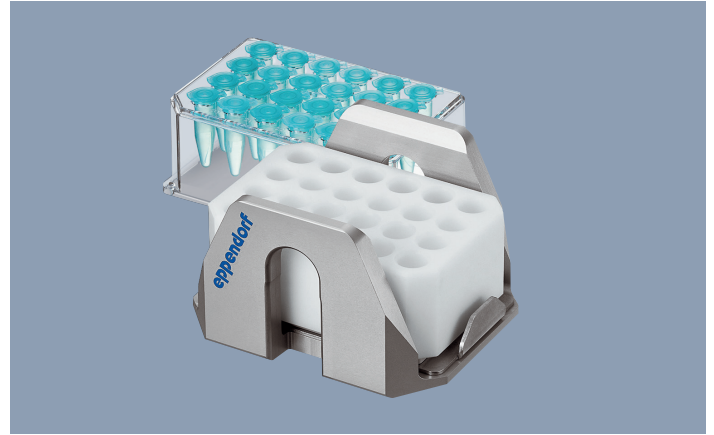

IsoRack adapter

- > IsoRack adapters to support 0.5 mL and 1.5/2 mL IsoRacks during centrifugation
- > Adapters can be used in Eppendorf plate rotors A-2-DWP, A-4-81-MTP/Flex and S-4-104

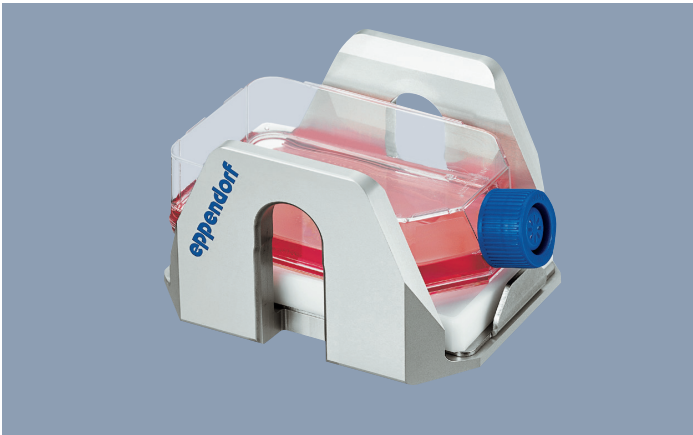

Cell culture flask adapter

- > Adapter to spin down cell cultures directly in a cell culture flask
- > Suitable for 25 cm² flasks
- > Adapters can be used with Rotor A-4-81-MTP/Flex

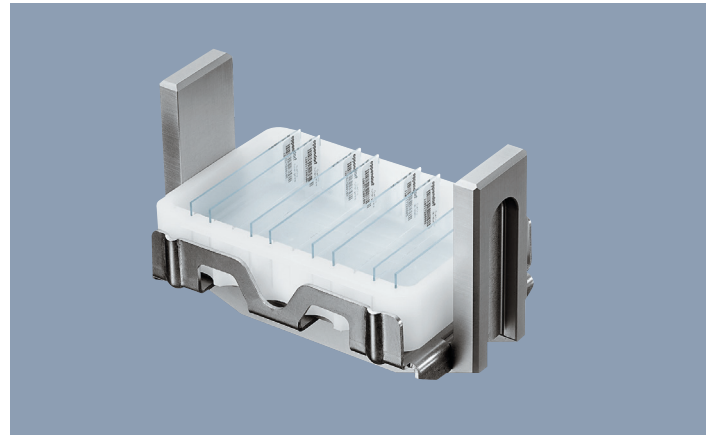

CombiSlide adapter

- > Designed for drying slides after hybridization experiments
- > Adapter can hold up to 12 regular glass slides
- > Removable inserts allow centrifugation of glass slides across and parallel to the direction of rotation
- > Adapters can be used in all Eppendorf plate rotors

Ordering information

Description	Order no
Adapter PCR 96-well plate, set of 2	5825 711 009
Adapter PCR 384-well plate, set of 2	5825 713 001
Adapter, for cell culture flasks, set of 2	5825 719 000
Adapter, for IsoRack 24 × 0.5 mL tubes, set of 2	5825 708 008
Adapter, for IsoRack 24 × 1.5/2 mL tubes, set of 2	5825 709 004
CombiSlide® adapter, for up to 12 glass slides, set of 2	5825 706 005









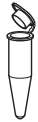

Rotor F-34-6-38

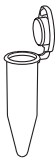

Product features

- > High-speed rotor for molecular biology applications in tubes from 0.2 mL to 85 mL
- > Max. speed 18,500 × *g* (12,000 rpm) in Centrifuge 5810 R or 15,500 × *g* (11,000 rpm) in 5804/5804R/5810*¹
- > Low rotor weight (3.2 kg) for easy handling
- > 34° borehole angle reduces pellet smears along tube wall
- > Anodized aluminum for high chemical resistance
- > Rotor, lid, and adapters are autoclavable

*1 Rotors F-34-6-38 and FA-45-6-30 maintain 4°C at 11,000 rpm.

Tube					
Common volumes (mL)	1.5/2	2–5 13 × 75 mm	4–7 13 × 100 mm	7–15	Eppendorf Tubes® 5.0 mL
Max. tube diameter (Ø mm)	11	13	13	16	17
Max. tube height for use lid (mm)	143	80	107	112	–
Adapter options for Rotor F-34-6-38					
Capacity per adapter/rotor	4/24	3/18	3/18	2/12	1/6
Adapter bottom shape	round	flat	flat	round	conical
Centrifugation radius (cm)	11.3	10.6	11.4	11.2	10.5
RCF (g-force) at at 12,100 rpm (5810 R)	18,200	17,070	18,350	18,000	16,824
at 11,000 rpm (5804/5804 R/5810)	15,300	14,340	15,420	15,150	14,150
Order no. (set of 2)	5804 770 005	5804 738 004	5804 739 000	5804 771 001	5804 777 000

*2 Nominal tube volume as published by the tube manufacturer.

Ordering information

Description	Order no.
Rotor F-34-6-38 for 6 × 85 mL tubes incl. rotor lid	5804 727 002



15 mL conical	15-18	20-30	50	50 mL conical	85*2
17	18	26	29	30	38
123	123	123	123	117	121

 no adapter
needed

1/6	1/6	1/6	1/6	1/6	1/6
conical	round	round	round	conical	round
10.7	10.9	11.0	11.2	10.8	11.5
17,200	17,550	17,700	18,000	17,400	18,500
14,450	14,750	14,900	15,150	14,600	15,500
5804 776 003	5804 772 008	5804 773 004	5804 774 000	5804 775 007	-

Rotor FA-45-6-30



Product features







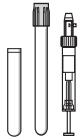
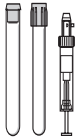

- > High-speed rotor for applications in tubes from 5–50 mL
- > Max. speed $20,130 \times g$ (12,100 rpm) in Centrifuge 5810 R or $16,639 \times g$ (11,000 rpm) in 5804/5804R/5810*¹
- > Eppendorf QuickLock rotor lid for fast lid locking
- > Aerosol-tight*² for safe centrifugation of hazardous samples
- > Low rotor weight (3.2 kg) for easy lifting
- > Anodized aluminum for high chemical resistance
- > 45° borehole angle minimizes pellets smear
- > Rotor, lid, and adapters are autoclavable

*1 Rotors F-34-6-38 and FA-45-6-30 maintain 4°C at 11,000 rpm.

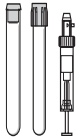
*2 Aerosol-tightness tested by Public Health England, Porton Down, UK.

Ordering information

Description	Order no.
Rotor FA-45-6-30* ³ , incl. aerosol-tight Eppendorf QuickLock® lid	5820 715 006

Tube					
Common volumes (mL)	2.6–5 13 × 75 mm	4–8 13 × 100 mm	5.5–10 16 × 75 mm	7.5–12 16 × 100 mm	Eppendorf Tubes® 5.0 mL
Max. tube diameter (Ø mm)	13	13	16	16	17
Max. tube height for use with aerosol-tight lid* ¹ (mm)	–	119	–	119	–
Adapter options for Rotor FA-45-6-30					
Capacity per adapter/rotor	1/6	1/6	1/6	1/6	1/6
Adapter bottom shape	round	round	round	round	conical
Centrifugation radius (cm)	12.0	12.0	12.0	12.0	12.1
RCF (g-force) at at 12,100 rpm (5810 R)	19,246	19,246	19,246	19,246	19,806
at 11,000 rpm (5804/5804 R/5810)	16,233	16,233	16,233	16,233	16,369
Order no. (set of 2)	5820 726 008	5820 725 001	5820 728 000	5820 727 004	5820 730 005







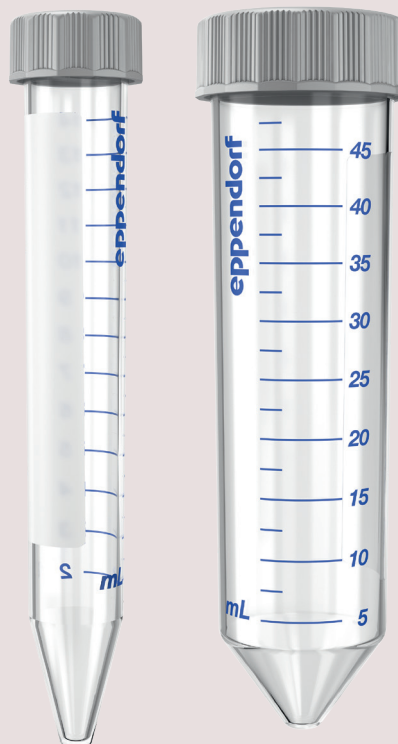

*³ Please note that a software upgrade may be necessary for older centrifuges when using Rotor FA-45-6-30. Please contact your local Eppendorf organization or dealer for further information.

Eppendorf Conical Tubes

Whether centrifugation, mixing, or other applications – the Eppendorf Conical Tubes 15 mL and 50 mL will perfectly fit into your workflows. They represent the next step in Eppendorf’s comprehensive system solutions in liquid, sample, and cell handling.

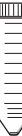
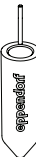
More information: www.eppendorf.com/conicals



					
7-17	15 mL conical	16	30	35	50 mL conical
17.5	17	18	26	29	30
122	125	107	104	113	127
					no adapter needed
1/6	1/6	1/6	1/6	1/6	1/6
round	conical	round	round	conical	conical
12.0	12.0	12.0	10.5	11.2	12.3
19,246	19,246	19,246	17,187	18,333	20,130
16,233	16,223	16,223	14,204	16,161	16,639
5820 729 007	5820 717 009	5820 720 000	5820 721 006	5820 722 002	-

Rotor F-35-48-17 and FA-45-20-17



Rotor F-35-48-17*1

- > High-capacity fixed-angle rotor for 15 mL conical and glass tubes
- > Max. speed: $5,005 \times g$ (5,500 rpm)
- > Form inserts for 15 mL conical tubes



Rotor FA-45-20-17*1

- > 20 places for Eppendorf Tubes® 5.0 mL
- > Max. speed: $20,913 \times g$ (13,100 rpm)
- > Eppendorf QuickLock rotor lid for fast lid locking
- > Rotor, lid and adapters are autoclavable
- > Anodized aluminum for high chemical resistance

Ordering information

Description	Order no
Fixed-angle Rotor F-35-48-17	
Includes 48 steel sleeves for 15 mL tubes, with 40 conical inserts and 48 rubber mats	5820 772 000
Includes 24 steel sleeves for 15 mL tubes, with 24 conical inserts and 24 rubber mats	5820 771 003
Fixed-angle rotor FA-45-20-17	
Rotor FA-45-20-17, 20 x 5.0 mL, incl aerosol-tight Eppendorf QuickLock® rotor lid	5820 765 003
Adapter for 1.5/2.0 mL tubes, set of 4	5820 768 002
Adapter for cryogenic vials, set of 4	5820 769 009
Adapter for HPLC tubes, set of 4	5820 770 007

*1 Please note that a software upgrade will be necessary for older centrifuges when using Rotor F-35-48-17 or FA-45-20-17. Please contact your local Eppendorf organization or dealer for further information.



Rotors F-45-30-11 and FA-45-30-11

- > 30 places for 1.5/2.0 mL tubes
- > Max. speed: 20,800 × g (14,000 rpm)
- > Rotor FA-45-30-11 comes with aerosol-tight*2 lid for safe centrifugation of hazardous samples
- > Rotors and lids are autoclavable

Rotor FA-45-48-11*3

- > 48 places for 1.5/2.0 mL tubes
- > Max. speed: 19,083 × g (max. 13,000 rpm)
- > Eppendorf QuickLock rotor lid for fast lid locking
- > Aerosol-tight*2 for safe centrifugation of hazardous samples
- > Anodized aluminum for high chemical resistance
- > Rotor and lid are autoclavable

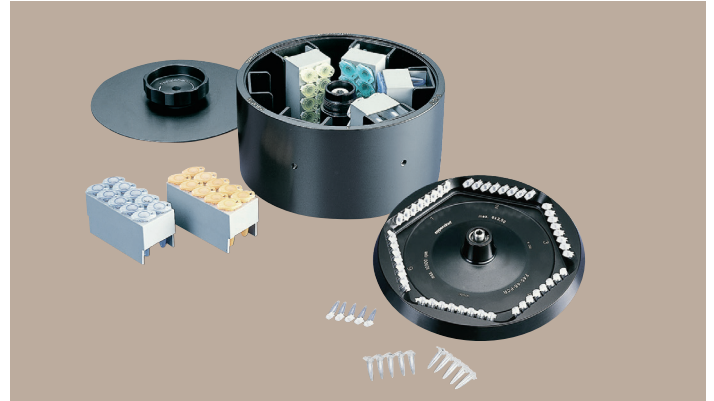

Drum Rotor T-60-11

- > High capacity for 60 × 1.5/2.0 mL tubes
- > Max. speed: 16,400 × g (14,000 rpm)
- > Horizontal centrifugation for pellet formation at tube bottom – ideal for low sample quantities

Rotor F-45-48-PCR

- > Accommodates up to 6 × 5/8-tube PCR strips or 48 × 0.2 mL PCR tubes
- > Safe and easy handling without additional lid
- > Max. speed: 15,350 × g (12,000 rpm)



Ordering information

Description	Order no
Rotor FA-45-48-11 , incl aerosol-tight Eppendorf QuickLock® rotor lid	5820 760 001
Rotor FA-45-30-11 , 30 × 1 5/2 0 mL, with aluminum lid, aerosol-tight*1	5804 726 006
Rotor F-45-30-11 , 30 × 1 5/2 0 mL, with aluminum lid	5804 715 004
Adapter for 0.2 mL PCR tubes (for 1 5/2 mL rotors), set of 6	5425 715 005
Adapter for 0.4 mL tubes (for 1 5/2 mL rotors), set of 6	5425 717 008
Adapter for 0.5 mL tubes (for 1 5/2 mL rotors), set of 6	5425 716 001
Adapter for BD Microtainer® (for 1 5/2 mL rotors), set of 6	5425 716 001
Drum rotor T-60-11 , with lid, without adapters	5804 730 003
Adapter for 10 × 1 5/2 mL tubes (Ø 11 mm), set of 6	5804 731 000
Adapter for 20 × 0.4 mL tubes (Ø 6 mm), set of 6	5804 732 006
Rotor F-45-48-PCR , for 6 × 8-tube PCR strips	5804 735 005

*2 Aerosol-tightness is tested and certified by Public Health England, Porton Down, UK

*3 Please note that a software upgrade will be necessary for older centrifuges when using Rotor FA-45-48-11. Please contact your local Eppendorf organization or dealer for further information.

Rolling Table

The new Eppendorf mobile tables save precious benchtop space and provide the freedom and flexibility to use your centrifuge wherever you need it.

The rolling tables are available in two options – low for a convenient under-bench storage of the device or high for an ergonomic working height.



Both options come with heavy duty wheels and brakes, so you can roll them wherever you need them in your lab. To ensure your safety, they are crash-tested according to IEC 61010-2-020, offering the same safety level as stationary lab benches.

Ordering information

Mobile table for under bench storage (low design) , fits under standard 90 cm lab benches with centrifuge lid closed, for Centrifuge 5804/5804 R, 5810/5810 R, 5910 Ri and 5920 R	5921 000 010
Mobile table for ergonomic loading and unloading (high design) , fits in any empty floor space, for Centrifuge 5804/5804 R, 5810/5810 R, 5910 Ri and 5920 R	5921 000 012

Centrifuge 5804/5804 R and 5810/5810 R

Technical specifications

Description	Centrifuge 5804	Centrifuge 5804 R	Centrifuge 5810	Centrifuge 5810 R
Max. rcf				
> Fixed-angle rotor	20,913 × g	20,913 × g	20,913 × g	20,913 × g
> Swing-bucket rotor	4,500 × g	4,500 × g	4,500 × g	4,500 × g
> Plate rotor	2,250 × g	2,250 × g	3,486 × g	3,486 × g
Speed	200–14,000 rpm (in 10 rpm increments)			
Max. capacity	4 × 250 mL	4 × 250 mL	4 × 750 mL	4 × 750 mL
Rotor options	12	12	18	18
Accel./Braking ramps	10/10			
Programs	35 user programs			
Timer	1 min. to 99 min, with continuous mode, short spin			
Temperature control range	N/A	–9 °C to 40 °C	N/A	–9 °C to 40 °C
Noise level				
> Rotor S-4-104 (4 × 750 mL)			<70 dB(A)	<56 dB(A)
> Rotor S-4-72 (4 × 250 mL)	<62 dB(A)	<58 dB(A)		
> Rotor FA-45-6-30 (6 × 50 mL)	<55 dB(A)	<54 dB(A)	<56 dB(A)	<55 dB(A)
Power supply	230 V/50–60 Hz	230 V/50–60 Hz	230 V/50–60 Hz	230 V/50–60 Hz
Power requirement	Max. 900 W	Max. 1,650 W	Max. 900 W	Max. 1,650 W
Dimensions (W × D × H)	47 × 55 × 34 cm	64 × 55 × 34 cm	54 × 61 × 35 cm	70 × 61 × 35 cm
Access height	28 cm	28 cm	28 cm	28 cm
Height with open lid	74 cm	74 cm	80 cm	80 cm
Weight without rotor	55 kg	80 kg	68 kg	99 kg

Centrifuge Packages



Ordering information

Cell culture centrifuge packages**

	Max. capacity of conical tubes per rotor	Order no.
Centrifuge 5804, with Rotor A-4-44 incl. adapters for 15 mL / 50 mL conical tubes	16 × 15 mL / 4 × 50 mL	*
Centrifuge 5804 R, refrigerated, with Rotor A-4-44 incl. adapters for 15 mL / 50 mL conical tubes	16 × 15 mL / 4 × 50 mL	*
Centrifuge 5804, with Rotor S-4-72 incl. adapters for 15 mL / 50 mL conical tubes	32 × 15 mL / 16 × 50 mL	*
Centrifuge 5804 R, refrigerated, with Rotor S-4-72 incl. adapters for 15 mL / 50 mL conical tubes	32 × 15 mL / 16 × 50 mL	*
Centrifuge 5810, with Rotor A-4-62 incl. adapters for 15 mL / 50 mL conical tubes	36 × 15 mL / 16 × 50 mL	*
Centrifuge 5810 R, refrigerated, with Rotor A-4-62 incl. adapters for 15 mL / 50 mL conical tubes	36 × 15 mL / 16 × 50 mL	*
Centrifuge 5810, with Rotor A-4-81 incl. adapters for 15 mL / 50 mL conical tubes	48 × 15 mL / 20 × 50 mL	*
Centrifuge 5810 R, refrigerated, with Rotor A-4-81 incl. adapters for 15 mL / 50 mL conical tubes	48 × 15 mL / 20 × 50 mL	*
Centrifuge 5810, with Rotor S-4-104 incl. adapters for 15 mL / 50 mL conical tubes	56 × 15 mL / 28 × 50 mL	*
Centrifuge 5810 R, refrigerated, with Rotor S-4-104 incl. adapters for 15 mL / 50 mL conical tubes	56 × 15 mL / 28 × 50 mL	*

**230 V/50–60 Hz

Technical specifications subject to change. Errors and omissions excepted.

> * For ordering information, please check our local website or contact your local sales representative.

www.eppendorf.com/centrifuge-5804



> * For ordering information, please check our local website or contact your local sales representative.

www.eppendorf.com/centrifuge-5810



Centrifuge packages for round-bottom tubes

	Max capacity of round-bottom tubes per rotor	Order no
Centrifuge 5810, with Rotor S-4-104 incl adapters for round-bottom tubes with diameter 13/16 mm	92 × 13 mm / 80 × 16 mm	5810 000 620
Centrifuge 5810 R, refrigerated, with Rotor S-4-104 incl adapters for round-bottom tubes with diameter 13/16 mm	92 × 13 mm / 80 × 16 mm	5811 000 820

*230 V/50–60 Hz

Technical specifications subject to change Errors and omissions excepted

Centrifuge Family Overview

Microcentrifuges

Centrifuge	MiniSpin®	MiniSpin® plus	5418 R	5420	5425	5425 R	5427 R	5430	5430 R
Description	Space saving 12-place mini-centrifuge		18-place microcentrifuge	Air-cooled 24-place microcentrifuge for basic molecular biology applications	Whisper quiet 24-place standard microcentrifuge with outstanding feature set for broad range of applications, refrigerated for temperature sensitive samples or non-refrigerated		High-throughput refrigerated 48-place microcentrifuge	Crossover microcentrifuge with multipurpose versatility	

Multipurpose Centrifuges

Centrifuge	5702	5702 R	5702 RH	5804	5804 R	5810	5810 R	5910 Ri	5920 R
Description	Low speed multipurpose centrifuge with medium capacity for clinical research and cell culture labs			High speed multipurpose centrifuge with medium capacity		Compact multipurpose centrifuge with medium capacity		Super versatile multipurpose centrifuge with an intuitive touch screen user interface and high capacity for a broad range of consumables, refrigerated for temperature sensitive samples	High-throughput multipurpose centrifuge with very high capacity

High-Speed Centrifuges

Centrifuge	CR22N
Description	High-speed floorstanding centrifuge with high capacity, ideal for harvesting of biomass in up to 6 L per run. Refrigerated for temperature sensitive samples

Centrifuge	CR30NX
Description	2-in-1 high-speed floorstanding centrifuge with vacuum function, suitable for applications with super-speed requirements up to 110,000 x g. Refrigerated for temperature sensitive samples

Ultracentrifuges

Centrifuge	CP100NX; CP90NX; CP80NX
Description	Ultracentrifuge with a broad rotor and consumable portfolio. Three versions with shared functionality but different speed offerings are available to match your speed requirements

Centrifuge	CS150FNX
Description	Floorstanding Micro-ultracentrifuge with speeds of up to 1,050,000 x g in a very compact design for labs with limited space availability

Centrifuge	CS150NX
Description	Benchtop Micro-ultracentrifuge with speeds of up to 1,050,000 x g, offering a flexible placement within the lab due the standard electricity requirements

Technical specifications subject to change. Errors and omissions excepted.

Your local distributor: www.eppendorf.com/contact
 Eppendorf SE · Barkhausenweg 1 · 22339 Hamburg · Germany
eppendorf@eppendorf.com · www.eppendorf.com

www.eppendorf.com/centrifugation

For more information, please check our local website or contact your local sales representative.

www.eppendorf.com/centrifugation

